



# ABB i-bus<sup>®</sup> KNX SMI Blind/Shutter Actuators Product Manual

Power and productivity  
for a better world™





## Contents

Page

<b>1</b>	<b>General .....</b>	<b>3</b>
1.1	Using the product manual.....	4
1.1.1	Structure of the product manual .....	4
1.1.2	Note .....	5
1.2	Product and functional overview.....	6
<b>2</b>	<b>Device Technology .....</b>	<b>7</b>
2.1	SMI Blind/Shutter Actuators JA/S 4.SMI.1M.....	7
2.1.1	Technical data JA/S 4.SMI.1M .....	7
2.1.2	Circuit diagram .....	9
2.1.3	Dimension drawing.....	10
2.2	SMI LoVo Blind/Shutter Actuator SJR/S 4.24.2.1 .....	11
2.2.1	Technical data SJR/S 4.24.2.1 .....	11
2.2.2	Circuit diagram .....	13
2.2.3	Dimension drawing.....	14
2.3	Assembly and installation .....	15
2.4	Manual operation.....	17
2.4.1	Display elements .....	18
2.4.2	Operating controls .....	18
<b>3</b>	<b>Commissioning.....</b>	<b>19</b>
3.1	Overview .....	19
3.2	Parameters.....	20
3.2.1	Parameter window <i>General</i> .....	21
3.2.2	Parameter window <i>Manual</i> .....	24
3.2.3	Parameter window <i>EIB/KNX</i> .....	26
3.2.4	Parameter window <i>Weather</i> .....	29
3.2.5	Parameter window <i>SMI Drives</i> .....	31
3.2.6	Parameter window <i>Output A - D</i> .....	32
3.2.7	Parameter window <i>Safety</i> .....	36
3.2.8	Parameter window <i>Status</i> .....	39
3.2.9	Parameter window <i>Position</i> .....	42
3.2.10	Parameter window <i>Position 1-4</i> .....	43
3.2.11	Parameter window <i>Auto 1</i> .....	45
3.2.12	Parameter window <i>Auto 2</i> .....	49
3.2.13	Parameter window <i>Output A-D Scene</i> .....	51
3.2.14	Parameter window <i>A-D Scene</i> .....	52
3.3	Communication objects .....	54
3.3.1	Brief overview of the communication objects.....	54
3.3.2	Communication objects <i>Output A...D</i> .....	56
3.3.3	Communication objects <i>General</i> .....	64
<b>4</b>	<b>Planning and Application.....</b>	<b>67</b>
4.1	Standard Motor Interface (SMI) .....	67
4.1.1	Introduction.....	67
4.1.2	Connection .....	67
4.1.3	Commissioning.....	68
4.1.4	SMI technical data .....	68
4.2	Move to position .....	69
4.3	Automatic controls.....	71
4.3.1	Automatic sun protection .....	71
4.3.2	Heating / cooling automatic .....	76

# ABB i-bus<sup>®</sup> KNX

## Contents

<b>A</b>	<b>Appendix.....</b>	<b>79</b>
A.1	Code table <i>Status byte</i> .....	79
A.2	Code table <i>Diagnostic byte</i> .....	80
A.3	Code table <i>Scene</i> (8 bit), DPT 18.001 .....	81
A.4	Ordering Information .....	82
A.5	Notes .....	83

## 1 General

### Shading

Modern building installation enables a high degree of functionality and simultaneously complies with increased security requirements. Due to the structured installation of the electrical components, it is possible to carry out rapid planning, installation and set-up as well as achieve cost benefits during operation.

A whole host of demands are placed on the sun protection devices:

- Anti-glare protection e.g. for PC workstations
- Utilization of daylight by tracking the sun's position and directing available daylight
- Protecting furniture and carpets from fading
- Regulating the room temperature, overheating protection in summer; harvesting the available energy on cold days
- Providing protection from people looking in from the outside
- Protection against intruders

The role of protection against the sun in buildings is increasing in significance due to increasing energy costs and statutory regulations. With intelligent and automated control via ABB i-bus<sup>®</sup> KNX, the SMI Actuators play a significant role in the energy efficiency of all kinds of buildings. The potential savings for cooling using automatic blind control were presented in a study by the Biberach University of Applied Sciences:

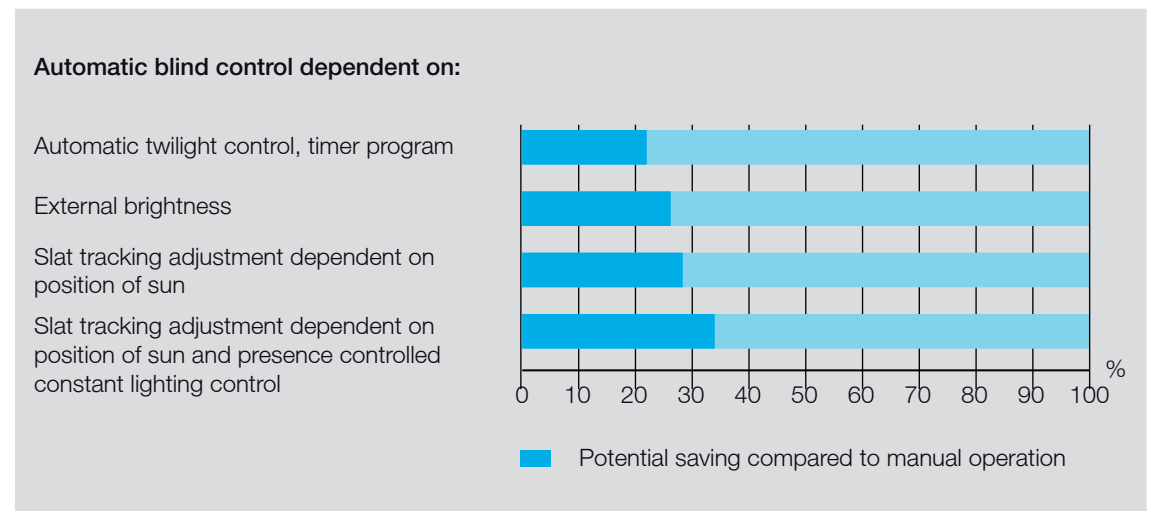

\* Determined by the Biberach University of Applied Sciences with ABB i-bus<sup>®</sup> KNX components for usage profile *open-plan office* (usage profile 3 [DIN V 18599-10:2005-07]) in an example building (classical office building) with the 5S IBP:18599 program. The potential savings relate to the energy consumption. The research results are included in the study *Energy saving and efficiency potential through the use of bus technology as well as room and building automation*, which was undertaken in 2008 for ABB STOTZ-KONTAKT GmbH and Busch-Jaeger Elektro GmbH.

## Standard Motor Interface (SMI)

The digital SMI interface between actuator and drive is supported by many manufacturers and has become established as the de facto standard for digital shutter control. SMI certified products from different manufacturers are compatible and can be operated simultaneously in a system.

The blind control with SMI enables even more exact positioning of the shutter/blinds as well as evaluation and display of status messages from the drive via the KNX.

## 1.1 Using the product manual

This manual provides you with detailed technical information relating to the function, installation and programming of the ABB i-bus<sup>®</sup> KNX SMI Blind/Shutter Actuators. The application of the device is explained using examples.

This manual is divided into the following sections:

- Chapter 1            General
- Chapter 2            Device technology
- Chapter 3            Commissioning
- Chapter 4            Planning and application
- Chapter A            Appendix

### 1.1.1 Structure of the product manual

All parameters are initially described in chapter 3. Directly following the parameter descriptions, you can find descriptions for the communication objects.

Note
The device features several outputs. However, as the functions and communication objects for all outputs are identical, only the functions of output A will be described.

## 1.1.2

### Note

Notes and safety instructions are represented as follows in this manual:



<b>Note</b>
Tips for usage and operation

<b>Examples</b>
Application examples, installation examples, programming examples

<b>Important</b>
These safety instructions are used as soon as there is danger of a malfunction without risk of damage or injury.

<b>Caution</b>
These safety instructions are used as soon as there is danger of a malfunction without risk of damage or injury.

 <b>Danger</b>
These safety instructions are used if there is a danger for life and limb with inappropriate use.

  <b>Danger</b>
These safety instructions are used if there is a danger to life with inappropriate use.

## 1.2 Product and functional overview

The SMI Actuators from ABB STOTZ-KONTAKT feature 4 independent outputs for control of SMI blinds or shutter drives. In total, up to 4 SMI drives can be connected in parallel to an output and operated in the group. The SMI drives are addressed automatically. SMI commissioning is unnecessary. The following functions are available with the application program.

- Move UP/DOWN, Stop/Louvre adjustment
- Move into position (up to 4 preset positions)
- Set position (modification of the preset position via KNX)
- Move to position 0...100 %
- Scenes
- Sun automatic control
- Heating/cooling automatic control
- Monitoring of wind, rain and frost alarms (cyclical)
- Block and forced operation
- Status display: current position/louvre position
- Status display: current operating mode
- Status display: current state of the SMI drive
- Modification of parameter settings via KNX



## 2 Device Technology

### 2.1 SMI Blind/Shutter Actuators JA/S 4.SMI.1M



JA/S 4.SMI.1M

2CDC 071 027 S0006

The SMI Blind/Shutter Actuator JA/S 4.SMI.1M controls four independent groups each with up to 4 SMI blind or shutter drives (230 V) for positioning blinds, shutters, awnings and other shutter/blinds via ABB i-bus<sup>®</sup> KNX.

The outputs can be directly controlled on the device using the manual pushbuttons. The LEDs on the front of the device signal the status of the outputs.

The Blind/Shutter Actuator is a modular installation device for installation in the distribution board on 35 mm mounting rails. The connection to the ABB i-bus<sup>®</sup> is implemented via bus connection terminals.

#### 2.1.1 Technical data JA/S 4.SMI.1M

<b>Supply</b>	Operating voltage	230 V AC +10/-15 %, 45...65 Hz
	Bus voltage	21 ...30 V DC via KNX
	Current consumption KNX	< 12 mA
	Power consumption KNX	Maximum 250 mW
	Power consumption 230 V AC	Maximum 2 W
	Leakage loss	Maximum 1.8 W
<b>Outputs</b>	4 individual SMI outputs	Up to 4 SMI drives (230 V) can each be connected in parallel
	SMI control voltage	18 V DC
	SMI cable lengths	Maximum 350 m
<b>Connections</b>	SMI	2 screw terminals per output (I+; I-) Conductor cross-section: Stranded: 0.2...2.5 mm <sup>2</sup> Solid: 0.2...4 mm <sup>2</sup>
	230 V AC power supply	2 screw terminals for L 2 screw terminals for N Conductor cross-section: Stranded: 0.2...2.5 mm <sup>2</sup> Solid: 0.2...4 mm <sup>2</sup>
	Tightening torque	Maximum 0.6 Nm
	ABB i-bus <sup>®</sup> KNX	Bus connection terminal (black/red), 0.8 mm Ø, single-core
<b>Operating and display elements</b>	Button/LED	For assignment of the physical address
	Buttons  and LEDs Two buttons and LEDs per output	For control (UP/DOWN (long actuation) or STOP/louvre adjustment (short operation) of the output and display of the status
	Button  and LED	For switchover between manual operation and operation via KNX
<b>Enclosure</b>	IP 20, EN 60 529	
<b>Safety class</b>	II, in the installed state	To EN 61 140
<b>Insulation category</b>	Overvoltage category	III to EN 60 664-1
	Pollution degree	2 to EN 60 664-1
<b>KNX safety extra low voltage</b>	SELV 24 V DC	

# ABB i-bus<sup>®</sup> KNX Device Technology

<b>Temperature range</b>	Operation	-5 °C...+45 °C
	Storage	-25 °C...+55 °C
	Transport	-25 °C...+70 °C
<b>Ambient conditions</b>	Maximum air humidity	93 %, no condensation allowed
<b>Design</b>	Modular installation device (MDRC)	ProM modular installation device
	Dimensions (H x W x D) in mm	90 x 72 x 64.5
	Mounting width in space units (modules at 18 mm)	4
	Mounting depth	64.5
<b>Weight (without batteries)</b>	Weight in kg	0.25
<b>Installation</b>	On 35 mm mounting rail	To EN 60 715
<b>Mounting position</b>	As required	
<b>Housing/colour</b>	Plastic housing, grey	Halogen free
<b>Approvals</b>	KNX to EN 50 090-1, -2 SMI	Certificate
<b>CE mark</b>	In accordance with the EMC guideline and low voltage guideline	

Device type	Application program	Maximum number of communication objects	Maximum number of group addresses	Maximum number of associations
J/AS 4.SMI.1M	Shutter SMI 4f M/...*	134	250	250

\* ... = current version number of the application program. **Please observe the software information on our homepage for this purpose.**

## Note

The ETS and the current version of the device application program are required for programming. The current version of the application program is available for download on the internet at [www.abb.com/knx](http://www.abb.com/knx). After import in the ETS, it is available in the ETS under *ABB/Shutter/Switch*. The device does not support the locking function of a KNX device in the ETS. If you inhibit access to all devices of the project with a *BCU code*, it has no effect on this device. It can still be read and programmed.

## 2.1.2

### Circuit diagram

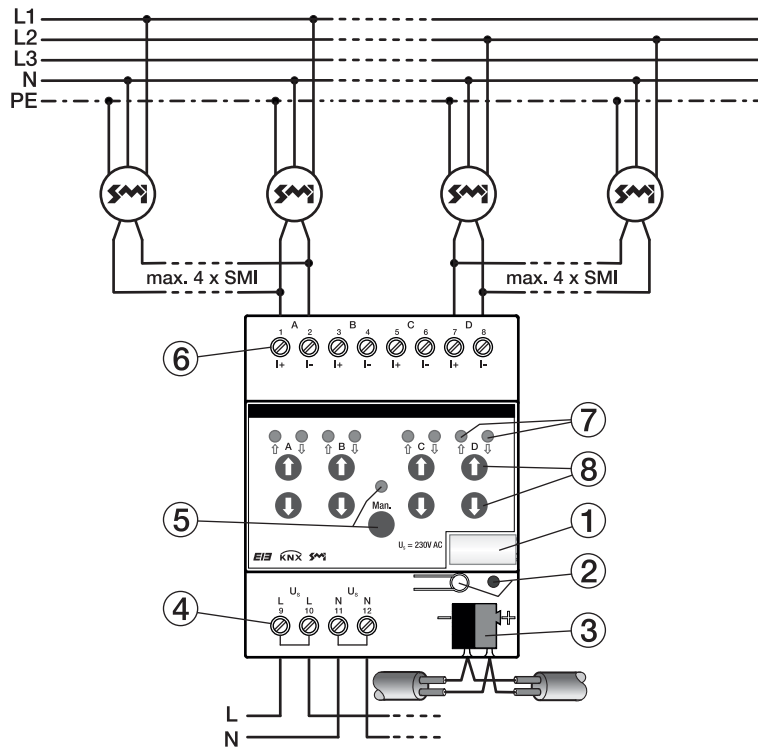

2CDC 072 037 F0011

- 1 Label carrier
- 2 Button/LED *Programming* (red)
- 3 Bus connection terminal
- 4 Auxiliary voltage 230 V AC
- 5 Button/LED *Manual operation* (yellow)
- 6 SMI connection terminals (I+; I-)
- 7 LED UP/DOWN/Position (yellow)
- 8 Buttons UP/DOWN/STOP/louvre adjustment

## 2.1.3

### Dimension drawing

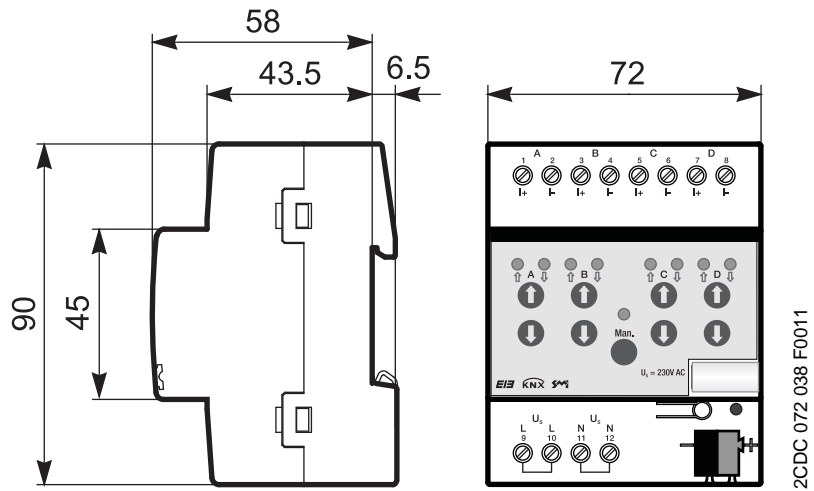

## 2.2 SMI LoVo Blind/Shutter Actuator SJR/S 4.24.2.1











2CDC 071 023 S0011

The SMI LoVo Blind/Shutter Actuator SJR/S 4.24.2.1 controls four independent groups each with up to 4 SMI LoVo blind or shutter drives (24 V) for positioning blinds, shutters, awnings and other shutters/blinds via ABB i-bus<sup>®</sup> KNX.

The outputs can be directly controlled on the device using the manual pushbuttons. The LEDs on the front of the device signal the status of the outputs.

The Blind/Shutter Actuator is a modular installation device for installation in the distribution board on 35 mm mounting rails. The connection to the ABB i-bus<sup>®</sup> is implemented via bus connection terminals.

### 2.2.1 Technical data SJR/S 4.24.2.1

<b>Supply</b>	Operating voltage	230 V AC +10/-15 %, 45...65 Hz
	Bus voltage	21 ...30 V DC via KNX
	Current consumption KNX	< 12 mA
	Power consumption KNX	Maximum 250 mW
	Power consumption 230 V AC	Maximum 2 W
	Leakage loss	Maximum 1.8 W
<b>Outputs</b>	4 individual SMI outputs	Up to 4 SMI LoVo drives (24 V) can each be connected in parallel
	SMI control voltage	18 V DC
	SMI cable lengths	Maximum 350 m
<b>Connections</b>	SMI	2 screw terminals per output (I+; I-) Conductor cross-section: Stranded: 0.2...2.5 mm <sup>2</sup> Solid: 0.2...4 mm <sup>2</sup>
	Auxiliary voltage 230 V AC	2 screw terminals for L 2 screw terminals for N Conductor cross-section: Stranded: 0.2...2.5 mm <sup>2</sup> Solid: 0.2...4 mm <sup>2</sup>
	Tightening torque	Maximum 0.6 Nm
	ABB i-bus <sup>®</sup> KNX	Bus connection terminal (black/red), 0.8 mm Ø, single-core
	<b>Operating and display elements</b>	Button/LED    Buttons   and LEDs   Two buttons and LEDs per output  Button  and LED 
<b>Enclosure</b>	IP 20, EN 60 529	
<b>Safety class</b>	II, in the installed state	To EN 61 140
<b>Isolation category</b>	Overvoltage category	III to EN 60 664-1
	Pollution degree	2 to EN 60 664-1
<b>KNX safety extra low voltage</b>	SELV 24 V DC	

# ABB i-bus<sup>®</sup> KNX Device Technology

<b>Temperature range</b>	Operation	-5 °C...+45 °C
	Storage	-25 °C...+55 °C
	Transport	-25 °C...+70 °C
<b>Ambient conditions</b>	Maximum air humidity	93 %, no condensation allowed
<b>Design</b>	Modular installation device (MDRC)	ProM modular installation device
	Dimensions (H x W x D) in mm	90 x 72 x 64.5
	Mounting width in space units (modules at 18 mm)	4
	Mounting depth	64.5
<b>Weight (without batteries)</b>	Weight in kg	0.25
<b>Installation</b>	On 35 mm mounting rail	To EN 60 715
<b>Mounting position</b>	As required	
<b>Housing/colour</b>	Plastic housing, grey	Halogen free
<b>Approvals</b>	KNX to EN 50 090-1, -2 SMI	Certification

Device type	Application program	Maximum number of communication objects	Maximum number of group addresses	Maximum number of associations
SJR/S 4.24.2.1	Shutter/Blinds SMI 4f LoVo M/...*	134	250	250

\* ... = current version number of the application program. **Please observe the software information on our homepage for this purpose.**

## Note

The ETS and the current version of the device application program are required for programming. The current version of the application program is available for download on the internet at [www.abb.com/knx](http://www.abb.com/knx). After import in the ETS, it is available in the ETS under *ABB/Shutter/Switch*. The device does not support the closing function of a KNX device in the ETS. If you inhibit access to all devices of the project with a *BCU code*, it has no effect on this device. It can still be read and programmed.

## 2.2.2

### Circuit diagram

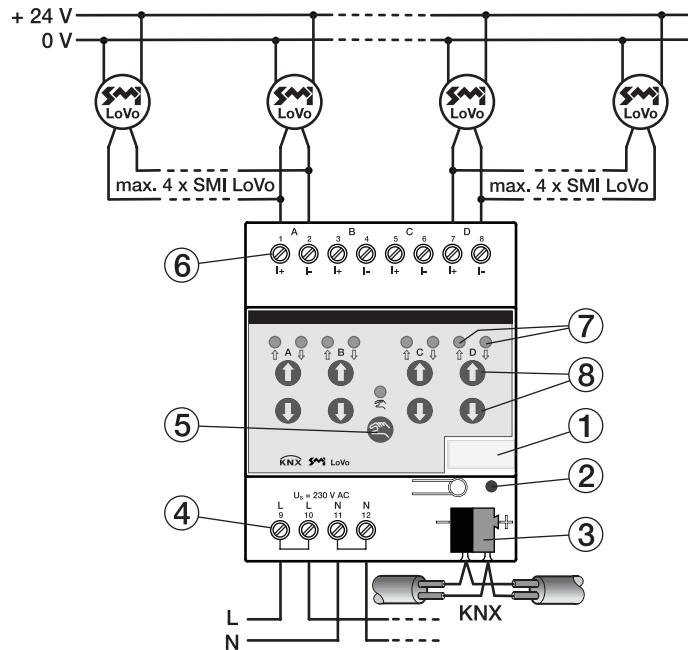

2CDC 072 088 F0010

- 1 Label carrier
- 2 Button/LED *Programming* (red)
- 3 Bus connection terminal
- 4 Auxiliary voltage 230 V AC
- 5 Button/LED *Manual operation* (yellow)
- 6 SMI LoVo connection terminals (I+; I-)
- 7 LED UP/DOWN/Position (yellow)
- 8 Buttons UP/DOWN/STOP/louvre adjustment

## 2.2.3

### Dimension drawing

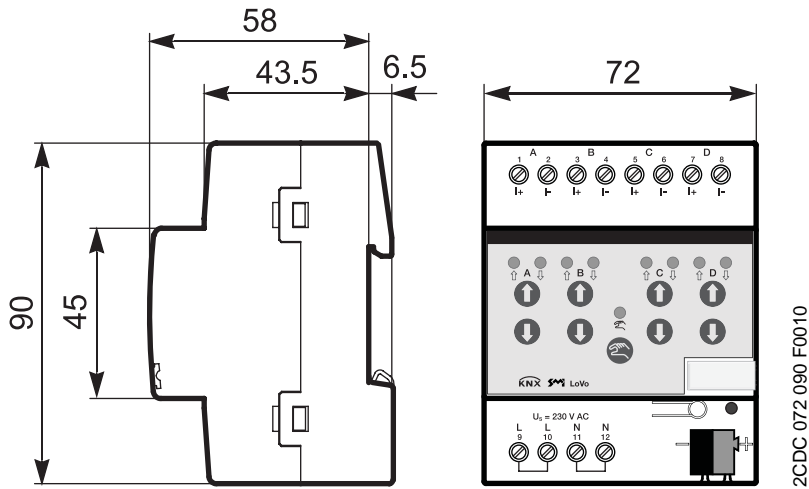



## 2.3 Assembly and installation

The SMI Blind/Shutter Actuators are modular installation devices for installation in the distribution board on 35 mm mounting rails to EN 60 715.

The mounting position can be selected as required.

The electrical connection is implemented using screw terminals. The connection to the bus is implemented using the supplied bus connection terminal. The terminal assignment is located on the housing.

The device is ready for operation after connection to the bus voltage.

Accessibility to the device for the purpose of operation, testing, visual inspection, maintenance and repair must be provided compliant to VDE 0100-520.

### Caution

Before the device is installed, the upper and lower end positions of the blind motor must be learned. The details supplied by the motor manufacturer must be observed. The end position values are stored in the shutter motor.

Connection of 230 V to the SMI control lines I+ and I- is strictly prohibited to prevent damage to the device!

If SMI drives are controlled via the KNX mode of the device, the connection of conventional buttons to the SMI control cable is prohibited.

### Note

The LED *Programming* ● (red) is supplied with power via the power supply of the device and via the bus. It lights up after pressing the *Programming* button even without a connection to the KNX. The LED can therefore only be used to verify the bus connection and for programming, if the bus voltage is available and the 230 V auxiliary supply has been disconnected.

### Commissioning requirements

In order to commission the device, a PC with ETS and a KNX interface, e.g. USB or IP, are required. The device is ready for operation after connection to the bus voltage.

The installation and commissioning may only be carried out by qualified electrical specialists. The appropriate norms, guidelines, regulations and specifications for your country should be observed when planning and setting up electrical installations and security systems for intrusion and fire detection.

Protect the device from damp, dirt and damage during transport, storage and operation.

Only operate the device within the specified technical data limits!

The device should only be operated in an enclosed housing (distribution board)!

The voltage supply to the device must be switched off, before mounting work is performed.



### Danger

In order to avoid dangerous touch voltages, which originate through feedback from differing phase conductors, all-pole disconnection must be observed when extending or modifying the electrical connections.

### **Manual operation**

The device incorporates manual operating features. Special device functions can be undertaken using the operating keys on the foil keypad.

The foil keypad may not be operated with pointed or sharp-edged objects, e.g. screwdrivers or pens. This may damage the keypad.

### **Supplied state**

The device is supplied with the physical address 15.15.255. The application program is preloaded. It is therefore only necessary to load group addresses and parameters during commissioning.

However, the complete application program can be reloaded if required. A longer downtime may result if the application program is changed or after a discharge. Manual operation does not function in the discharged state.

### **Assignment of the physical address**

The assignment and programming of the physical address is carried out in the ETS.

The device features a *Programming* button for assignment of the physical device address. The red LED *Programming* lights up after the button has been pushed. It switches off as soon as the ETS has assigned the physical address or the *Programming* button is pressed again.

### **Download response**

Depending on the PC, which is used, the progress bar for the download may take up to one and a half minutes, before it appears, due to the complexity of the device.

### **Cleaning**

If devices become dirty, they can be cleaned using a dry cloth or a cloth dampened with a soapy solution. Corrosive agents or solutions should never be used.

### **Maintenance**

The device is maintenance-free. No repairs should be carried out by unauthorised personnel if damage occurs, e.g. during transport and/or storage.

## 2.4 Manual operation

### General

The outputs can be directly controlled using the buttons in manual operation.

Accordingly, the wiring of the drives connected to the outputs can be verified during commissioning. You can, for example, ensure that the connected blind drives moves up and down correctly. If bus voltage is not yet available at the time of commissioning, the device can be supplied with power for manual operation using the Power Supply NTI/Z.



### Function of manual operation

Manual operation facilitates on-location operation of the device. As standard the button  *Manual operation* is enabled and can be switched on and off using it.

Switch on of manual operation:

Press button  until the yellow LED  lights continuously.

Switch off of manual operation:

Press button  until the yellow LED  switches off.

The yellow LED  flashes during the switchover process.

After connection to the KNX, an ETS download or ETS reset, the device is in *KNX operation*. The LED  is off. All LEDs indicate the current state.

#### Note

If the *Manual operation* is generally disabled or disabled via communication object *Enable/block manual operation*, the LED  flashes during a button push.  
A switchover from *KNX operation* to the *Manual operation* mode does not occur.

#### Important

Safety telegrams such as weather alarms, blocking and forced operation have the highest priority and block manual operation. This is carried out if manual operation is activated and a safety telegram is received. The reaction after bus voltage recovery, programming or ETS reset can be set using the ETS parameters.

### Supplied state

Manual operation is enabled by default in the supplied state. The device is in *KNX operation* after connection to the bus. The yellow LED  is off. All LEDs for the outputs indicate the actual state. The buttons for the outputs are non-functional.

In the default delivery state, the *Blinds* operating mode is preloaded. If a short UP/DOWN telegram (step) is triggered via the manual operation, it is possible that short jerky movements will result in the connected roller blinds in *Blinds* operating mode. In order to avoid this reaction when roller blinds are connected, the *Shutter* operating mode should be selected in the application program and loaded in the device.

### Telegram processing with active manual operation

Incoming safety telegrams such as weather alarms, blocking and forced operation have the highest priority and are implemented. All other telegrams are received and stored. After manual operation is deactivated, the device will update.









If a telegram with the value 1 is received via communication object *Enable/block manual operation*, active manual operation is deactivated and then blocked. Manual operation can no longer be activated by the manual buttons.

## 2.4.1 Display elements

Indicator LEDs are located on the front of the device.

All LEDs *Output X* indicate the actual state. In *KNX operation* the LED  is off.



The response of the display elements is described in the following table:

LED	KNX operation	Manual operation
  <b>Manual operation</b>	<i>Off</i> : The device is in KNX mode <i>Flashes (for about 3 seconds)</i> : Changeover to manual mode. <i>Flashes continuously</i> : The LED flashes, until button  is pressed. The LED  switches off when released.	<i>On</i> : The device is in manual mode. <i>Flashes (for about 3 seconds)</i> : Changeover to KNX mode.
 <b>Output A...X UP/DOWN</b>	<i>On  ↑</i> : Upper limit position. <i>On  ↓</i> : Lower limit position. <i>Flashes  ↑</i> : Shutter/blind moving upwards. <i>Flashes  ↓</i> : Shutter/blinds moving downwards. <i>Both LEDs quickly flash alternately</i> : SMI communication fault, e.g. no drive is connected to this output, 230 V auxiliary voltage is not available or SMI data line is damaged. <i>Both LEDs slowly flash alternately</i> : Function <i>Safety</i> active, e.g. wind alarm. Manual operation of this output is blocked as long as the alarm is active. <i>Both LEDs flash simultaneously</i> : Non-permissible number of SMI drives is connected. <i>OFF</i> : Intermediate position or no voltage available.	

## 2.4.2 Operating controls

Buttons for manual operation are located on the front of the device.

The behaviour of the operating elements dependent on the operating states *KNX* - operation and *Manual* operation is described in the following table:

Button	KNX operation	Manual operation
 <b>Manual operation</b>	<i>Long button operation (about 3 sec.)</i> : Switch to <i>Manual operation</i> , provided that <i>Manual operation</i> is not blocked by a parameter setting. <i>Short button push</i> : LED  <i>Manual operation</i> flashes and switches off again. The device is once again in <i>Manual operation</i> .	<i>Long button operation (about 3 sec.)</i> : Changeover to the <i>KNX operation</i> . The inputs are queried again, and the input states are updated accordingly. The reset of manual operation to <i>KNX operation</i> can be undertaken in a programmable time, depending on the parameterization.
 <b>Output A...X UP/DOWN</b>	No reaction	<i>Long operation</i> : UP/DOWN or opening/closing of the contact. <i>Short operation</i> : Louvre adjustment*/STOP.

\* Louvre adjustment only on operation mode *Blinds*. During the operating mode *Shutter*, the travel stops with short actuation.

## 3 Commissioning

### Caution

Before the device is installed, the upper and lower end positions of the blind motor must be learned. The details supplied by the motor manufacturer must be observed. The end position values are stored in the shutter motor.

In order to guarantee simple programming, the application program is structured dynamically, i.e. in the basic setting only very few important communication objects and parameters are visible. The full functionality of the application program becomes visible via the activation of the respective parameters.

The parameter settings can be undertaken for every output separately and are the same for all outputs. Thus, the programming effort can be considerably reduced when setting the parameters. In both cases, the communication objects are available separately for every object.

The device can either be operated in individual mode (one SMI drive per output) or in parallel mode with multiple addressing (up to 4 SMI drives as a group per output). Accordingly, no SMI addressing is necessary during commissioning. The SMI Actuators JA/S 4.SMI.1M and JRA/S 4.24.2.1 cyclically check the bus for (new) drives and can detect and resolve them in cases of an address conflict.

For the exchange and commissioning of an SMI drive, no SMI addressing must be undertaken. Any SMI drives from various manufacturers can be combined with one another.

### 3.1

### Overview

Overview of the functions in a tabular form:

<b>SMI Blind/Shutter Actuators</b>	<b>JA/S 4.SMI.1M</b>	<b>SJR/S 4.24.2.1</b>
Type of installation	MDRC	MDRC
Module width (space units)	4	4
Number of outputs	4	4
Number of SMI drives per output	4 x SMI 230 V (parallel)	4 x SMI LoVo 24 V (parallel)
Manual operation	■	■
Display output status	■	■

■ = property applies

<b>General parameterization options</b>	<b>JA/S 4.SMI.1M</b>	<b>SJR/S 4.24.2.1</b>
<b>Manual functions</b>		
Enable/release manual operation	■	■
Manual operating status	■	■
Status auxiliary voltage / SMI supply voltage	■	■
<b>Operating modes</b>		
Shutters	■	■
Blinds	■	■
<b>Continued overleaf</b>		

General parameterization options	JA/S 4.SMI.1M	SJR/S 4.24.2.1
<b>General device functions</b>		
Parameter settings for outputs similar/individual	■	■
Limit number of telegrams	■	■
Time-delayed switching of drives	■	■
Parameter changes via KNX	■	■
<b>Weather/safety</b>		
Wind alarm	■	■
Rain alarm	■	■
Frost alarm	■	■
Block	■	■
Forced operation	■	■
<b>Automatic</b>		
Automatic sun protection	■	■
Heating / cooling automatic	■	■
<b>Status messages</b>		
Status of positions/limit position	■	■
Status byte	■	■
Status of operation	■	■
Status automatic control	■	■
Status SMI	■	■
SMI diagnostic byte	■	■
<b>Direct functions</b>		
UP/DOWN/STOP	■	■
Louvre adjustment	■	■
Position height/louvre 0...255	■	■
Preset Move to position/Set position	■	■
8 bit scene	■	■

■ = property applies

## 3.2 Parameters

Programming of the device is implemented with the Engineering Tool Software ETS.

The application program is available in the product catalogue of the ETS under *ABB/Shutter/Switch*.

The following chapter describes the parameters of the device using the parameter window. The parameter window features a dynamic structure, so that further parameters may be enabled depending on the parameterization and the function.

The default values of the parameters are underlined,

e.g.:

Options:     yes  
              no

## 3.2.1

### Parameter window *General*

In this parameter, the parameters are defined that determine the overall behaviour of the device.

General	Parameter settings	similar for all outputs
Manual		
EIB/KNX		
Weather		
SMI drives	Time-delayed switching of drives	deactivated
Output A - D		
Safety		
Status	Maximum telegram rate	1 telegram per second
Position		
Position 1-4		
Auto 1	Allow parameter changes via EIB/KNX	no
Output A-D scene		

#### Parameter settings

Options: similar for all outputs  
individual for every output

This parameter defines whether the parameter settings for every output are individual or similar. If all outputs are programmed similarly, the programming work is reduced considerably with large systems.

- *similar for all outputs*: The parameter window *Output A-D* appears as well as the corresponding parameter windows once. All settings made there apply equally for all outputs.
- *individual for every output*: The parameter window *Output A-D* appears as well as the corresponding parameter windows four times. All settings are undertaken for each output individually.

#### Time-delayed switching of drives

Options: deactivated  
activated

In larger systems, a high starting current peak is generated if all drives start simultaneously due to central telegrams. The starting current peak can be limited by a time delayed switching of the outputs. The central travel telegrams are executed with a delay. The time delay when implementing a travel movement applies for the following communication objects or states (even for activated automatic control):

- *Move to pos. for sun 0..255, Adjust louvres for sun 0..255*
- *Block, Forced operation*
- *Wind alarm, Rain alarm, Frost alarm*
- *Move to position 0..255*
- *Move louvre 0..255*
- *Programming, ETS reset*
- *Bus voltage failure*
- *Bus voltage recovery*
- *Reaction on auxiliary voltage recovery, SMI reset*
- *SMI Recovery*

The time delay when undertaking a movement is not considered for the following communication objects:

- *Move blinds Up-Down, Blinds Up-Down limited*
- *Move shutter Up-Down, Shutter Up-Down limited*
- *Louvre adj./STOP, STOP*
- *Move to position 1/2, Move to position 3/4*

It is thus ensured that the direct operation function – e.g. via a pushbutton – is not time delayed.

- *activated*: The following parameter appears:

**Time delay [s]**

**1...15**

Options: 1...15

This parameter determines the time delay used by the outputs when they switch successively. The set time delay applies for all outputs or connected drives of the actuator.

### Caution

The parameterized time delay also applies for automatic control, weather alarms and forced operations. Therefore, the time delay should only be used in large systems if a mains voltage failure is to be expected when all the drives start-up simultaneously.

#### Maximum telegram rate

Options: 1/2/3/5/10/20 telegrams per second

The telegram rate can be limited with this parameter in order to limit the number of status telegrams.

With central telegrams or after a bus voltage recovery, it is possible that the device sends several status telegrams via the KNX. If several SMI Actuators operate parallel in the system or if they are even operated on the same line, it is possible that a flood of telegrams will result. Therefore, the maximum telegram rate in large KNX installations should be kept as low as possible.

#### Allow parameter changes via EIB/KNX

Options: yes  
no

This parameter defines whether certain parameter settings can be changed via an individual telegram with a central group address via KNX. In this way, various settings can be tested during commissioning without the necessity for making the changes for each individual parameter or each individual device in various parameter windows. Reprogramming of the individual devices also becomes unnecessary. Thus the setting of all SMI Actuators occurs quickly and simultaneously.



# ABB i-bus<sup>®</sup> KNX Commissioning

The following parameters that can be found in the parameter windows *Auto 1* and *Auto 2* can be modified with this function:

- *Time to reactivate automatic control automatically [min.] 10...6,000*
- *Delay for sun = 1 (sun)*
- *Delay for sun = 0 (no sun)*
- *Delay for presence = "1" [s] 0...6,000*
- *Delay for presence = "0" [s] 0...6,000*

Note
Changes via KNX apply for all 4 outputs and are bus voltage failure safe.

With this function, for example, various delay times can be tested for the reaction to *Sun = 1* or the time for automatic reactivation of the automatic control can be centrally modified.

- *yes*: The parameter *Overwrite parameter changing on download* as well as the communication objects *Time for automatic reactivation*, *Delay for sun = X* and *Delay for presence = X* appear.

Note
If parameter changes have been made via the KNX during commissioning, the parameter settings in the device are different from the parameterized parameter settings in the ETS. The final parameter settings should be well documented or subsequently corrected in the parameter windows, to ensure that the function of the system can be restored at any time.

### Overwrite parameter changing on download

Options:    yes  
              no

This parameter determines if the parameter changes via KNX during a download are overwritten by the parameterized settings in the ETS.

## 3.2.2

### Parameter window *Manual*

In this parameter window, all the settings for manual operation are undertaken.

General	Manual operation	enabled
<b>Manual</b>	Reset manual operation to EIB/KNX operation	automatically and via push button
EIB/KNX	Time for automatic reset [s]	300
Weather	Send status of manual operation	no
SMI drives	Send status auxiliary voltage/ SMI supply voltage	no
Output A - D		
Safety		
Status		
Position		
Position 1-4		
Auto 1		
Output A-D scene		



(The status is always sent after a change of value.)

#### Manual operation

Options: enabled  
disabled  
via object enable/ disable

This parameter defines if the switch over between the operating states manual operation and KNX operation is enabled or disabled via the button  on the device.

- *enabled*: With its selection, the outputs can be directly controlled using the manual buttons.
- *disabled*: With its selection, manual operation is disabled. The outputs can no longer be operated via the manual buttons.
- *via object enable/disable*: The communication object *Enable/block manual operation* appears. Manual operation can be enabled or disabled via the bus with this communication object.



Telegram value: 0 = button  enabled  
1 = button  disabled

For further information see: [Manual operation](#), page 17

## Reset manual operation to EIB/KNX operation

Options:       via push button  
                  automatically and via push button

This parameter determines how long manual operation remains activated or after how long switch over to KNX operation occurs. It appears when the parameter option *via enable/disable* or *enable* are selected.

- *via push button*: Manual operation remains activated until it is deactivated again using the manual operation button  or using the communication object.
- *automatically and via push button*: Manual operation remains activated after the last operation of the button until the parameterized time has timed out or it is deactivated again using the manual button . The following parameter appears:

### Time for automatic reset [s] [10...6,000]

Options:       10...300...6,000

Manual operation remains activated, until the parameterized time has timed out or it is deactivated again using the manual button .

## Send status of manual operation

Options:       yes  
                  no

The device can be switched over between manual operation and KNX operation via the *Man* button. The status of the current manual mode is sent via the KNX.

- *yes*: The communication object *Telegr. status of man. operation* is enabled.

## Send status auxiliary voltage/ SMI supply voltage

Options:       yes  
                  no

- *yes*: The communication object *Telegr. status of auxiliary voltage* is enabled.

### Note

If the auxiliary voltage (230 V) fails, the SMI supply is also interrupted. The reaction of the auxiliary voltage supply depends on the SMI drive and should be read in the technical documentation of the respective manufacturer.

With the return of the auxiliary voltage, the device reads the value of the communication objects and positions the shutter/blind accordingly, e.g. activation of the function *Automatic* or travel to the position *Wind alarm*. Telegrams are carried out in accordance with the parameterized time delay.

**(The status is always sent after a change of value.)**

## 3.2.3 Parameter window *EIB/KNX*

In this parameter window, all settings for the reaction after bus voltage failure/recovery, auxiliary voltage recovery, programming and ETS reset are undertaken.

General	Reaction on programming/ reset	
Manual	Position after programming/ reset	STOP
<b>EIB/KNX</b>	Read automatic objects	no
Weather	Reaction on bus voltage failure (Auxiliary voltage must be applied!)	
SMI drives	Position on bus voltage failure	STOP
Output A - D	Reaction on bus voltage recovery (Auxiliary voltage must be applied!)	
Safety	Position after bus voltage recovery	STOP
Status	Read automatic- and safety objects	no
Position	Reaction on auxiliary voltage recovery	
Position 1-4	Position after aux. voltage recovery	STOP
Auto 1		
Output A-D scene		

### Reaction on programming/reset

No movement actions are undertaken during programming or during an ETS reset. Manual operation is automatically deactivated and cannot be reactivated until the completion of programming or an ETS reset. If the shutter/blind is undertaking a movement function at the start of programming or during the ETS reset, the movement continues to the target position.

#### Position after programming/reset

Options:     no reaction  
              UP  
              DOWN  
              STOP  
              Position 1...4

With this parameter, the shutter/blind position is set after programming or a reset.

After completion of the programming or the ETS reset, the shutter/blind is moved to the parameterized position. The current position of the shutter/blind as well as the status of the drive is queried via SMI, and the feedback communication objects are updated. The device is operating in KNX mode, and the LED  is off.

- *no reaction*: If the shutter/blind is performing a movement, this movement action to the target position is carried out. If the shutter/blind is at rest, it will remain in its position unchanged.
- *STOP*: If the shutter/blind is performing a movement, this movement stops immediately. If the shutter/blind is at rest, it will remain in its position unchanged.
- *Position 1...4*: If this position is selected, the shutter/blind moves to a preset position after programming/reset. The shutter/blind height and louvre setting of the corresponding position can be set in the parameter windows *Position 1-4*.

## Read automatic objects

Options:     yes  
              no

This parameter defines if the communication objects *Automatic* (No. 10...17) read their value via KNX.

The communication objects *Automatic* assume the value 0 after programming and ETS reset. The current values of the communication objects *Automatic* can be requested via KNX. If this has occurred, the status of the actuator is updated to correspond to the read values, e.g. automatic control is activated.

## Reaction on bus voltage failure (Auxiliary voltage must be applied!)

### Position on bus voltage failure

Options:     no reaction  
              UP  
              DOWN  
              STOP  
              Position 1...4

With a bus voltage failure, the shutter/blind is moved to the parameterized position (only with existing 230 V auxiliary voltage).

- *no reaction*: If the shutter/blind is performing a movement, this movement action to the target position is carried out. If the shutter/blind is at rest, it will remain in its position unchanged.
- *STOP*: If the shutter/blind is performing a movement, this movement stops immediately. If the shutter/blind is at rest, it will remain in its position unchanged.
- *Position 1...4*: If this position is selected, the shutter/blind moves to a preset position after bus voltage failure. The shutter/blind height and louvre setting of the corresponding position can be set in the parameter windows *Position 1-4*.

## Reaction on bus voltage recovery (Auxiliary voltage must be applied!)

### Position after bus voltage recovery

Options:     no reaction  
              UP  
              DOWN  
              STOP  
              Position 1...4

At bus voltage recovery, the shutter/blind is moved to the parameterized position (only with existing 230 V auxiliary voltage). The current position of the shutter/blind as well as the status of the drive is queried via SMI, and the feedback communication objects are updated. The actuator remains in KNX operation or Manual operation.

- *no reaction*: If the shutter/blind is performing a movement, this movement action to the target position is carried out. If the shutter/blind is at rest, it will remain in its position unchanged.
- *STOP*: If the shutter/blind is performing a movement, this movement stops immediately. If the shutter/blind is at rest, it will remain in its position unchanged.

- *Position 1...4*: If this position is selected, the shutter/blind moves to a preset position after bus voltage recovery. The shutter/blind height and louvre setting of the corresponding position can be set in the parameter windows *Position 1-4*.

#### Read automatic- and safety objects

Options:      yes - safety, automatic  
                  yes – safety  
                  yes – automatic  
                  no

With this parameter, you set if the automatic communication objects *Automatic* (No. 10...17) and communication objects *Safety* (No. 19...20 and No. 124...128) read their value via KNX.

The communication objects *Automatic* and *Safety* assume the value 0 after programming and ETS reset. The current value of the communication objects *Automatic* and *Safety* can be requested via the KNX. If this has occurred, the status of the actuator is updated to correspond to the read values, e.g. automatic control is activated.

#### Reaction on auxiliary voltage recovery

##### Position after auxiliary voltage recovery

After auxiliary voltage recovery, the shutter/blind moves to the parameterized position. The current position of the shutter/blind as well as the status of the drive are queried via the SMI and the feedback communication objects are updated (only if bus voltage available). The actuator remains in KNX operation or Manual operation.

Options:      no reaction  
                  UP  
                  DOWN  
                  STOP  
                  Position 1...4  
                  according to object value

- *no reaction*: The shutter/blind remains unchanged in its current position.
- *STOP*: If the shutter/blind is performing a movement, this movement stops immediately. If the shutter/blind is at rest, it will remain in its position unchanged.
- *Position 1...4*: If this position is selected, the shutter/blind moves to a preset position after auxiliary voltage recovery. The shutter/blind height and louvre setting of the corresponding position can be set in the parameter windows *Position 1...4*.
- *according to object value*: Incoming KNX telegrams during a failure of the auxiliary voltage are saved (only if bus voltage available). After auxiliary voltage recovery, the shutter/blind is moved to the position which was last received on the following communication objects:
  - *Move to position 1/2/3/4*
  - *Move to position 0..255*
  - *Move louvre 0..255*

The position after auxiliary voltage recovery is only moved to if

- no weather or safety alarm is active,
- manual operation is inactive and
- automatic control is inactive.

The positions are traveled to only after a parameterized delay.

## 3.2.4 Parameter window *Weather*

In this parameter window, all higher level settings affecting the weather alarms are undertaken.

General	Order of priority for weather alarm functions	1.Wind alarm - 2.Rain alarm - 3.Frost alarm
Manual	Communication object no. 1 for wind alarm	deactivated
EIB/KNX	Communication object no. 2 for wind alarm	deactivated
<b>Weather</b>	Communication object no. 3 for wind alarm	deactivated
SMI drives	Monitoring period for wind alarm [s] 0..1,000 (0 = monitoring deact.)	0
Output A - D	Communication object for rain alarm	deactivated
Safety	Communication object for frost alarm	deactivated
Status		
Position		
Position 1-4		
Auto 1		
Output A-D scene		

### Order of priority for weather alarm functions

Options: 1.Wind alarm - 2.Rain alarm - 3.Frost alarm  
 1.Wind alarm - 2.Frost alarm - 3.Rain alarm  
 1.Rain alarm - 2.Wind alarm - 3.Frost alarm  
 1.Rain alarm - 2.Frost alarm - 3.Wind alarm  
 1.Frost alarm - 2.Rain alarm - 3.Wind alarm  
 1.Frost alarm - 2.Wind alarm - 3.Rain alarm

This parameter defines the priority between the weather alarm functions. If more than one weather alarm occurs simultaneously, then only one weather alarm with the highest priority is carried out.

### Communication object no. 1 for wind alarm

### Communication object no. 2 for wind alarm

### Communication object no. 3 for wind alarm

### Communication object for rain alarm

### Communication object for frost alarm

Options: deactivated  
 activated

This parameter activates the weather alarm functions and the corresponding communication objects.

- *activated*: The parameters for the monitoring times of the weather alarms appear.

Note
<p>Wind, rain and frost alarms are only activated when in parameter window <i>A: Safety/Weather</i> a position has been activated with the weather alarm:            Example:  <b>Position on wind alarm</b>            Option: activated - up</p>

**Monitoring period for wind alarm [s]**

**Monitoring period for rain alarm [s]**

**Monitoring period for frost alarm [s]**

**[0...1,000] (0 = monitoring deact.)**

Options: 0...1,000

These parameters determine the cyclical monitoring time for wind, rain and frost alarms in seconds.

The weather alarms of the weather sensors are cyclically monitored.

If the weather sensor sends the telegram value 0, there is no weather alarm. The SMI Actuator expects this signal. If the signal is not received within the parameterized monitoring period, it can be assumed that the sensor is defective or the bus line has been interrupted. The shutter/blinds are moved to the parameterized alarm position. The operation is inhibited.

If the weather sensor sends the telegram value 1 (weather alarm), the shutters/blinds immediately move to the parameterized alarm position. The parameter *Monitoring period for rain alarm in s* or *Monitoring period for frost alarm in s* is displayed, as soon as the parameters *Communication object for rain alarm* or *Communication object for frost alarm* have been set with the option *activated*.

- 0: The cyclical monitoring is deactivated.

Note
The monitoring period should be selected to be at least three to four times as large as the cyclical transmission time of the sensor. In this way, the immediate absence of a signal, e.g. due to a high bus load, does not immediately result in the shutter/blinds being moved to the alarm position



## 3.2.5 Parameter window *SMI drives*

In this parameter window, all higher-level settings for the SMI drives are undertaken.

The screenshot shows a software interface for configuring SMI drives. On the left is a vertical menu with the following items: General, Manual, EIB/KNX, Weather, SMI drives (highlighted), Output A - D, Safety, Status, Position, Position 1-4, Auto 1, and Output A-D scene. The main area on the right contains four rows of settings, each with a label and a numeric input field with up/down arrows:

Number of SMI drives Output A	1
Number of SMI drives Output B	1
Number of SMI drives Output C	1
Number of SMI drives Output D	1

### Number of SMI drives Output A

### Number of SMI drives Output B

### Number of SMI drives Output C

### Number of SMI drives Output D

Options: 0, 1...4

This parameter defines the number of drives that can be connected to each SMI output.

Regular scanning of all drives connected to an SMI output can detect a missing or additional drive, and a telegram is sent to communications object *Teleg. status number of drives* (No. 29).

A maximum of four SMI drives can be connected to an output.

- 0: The output is inactive

#### Note

If more than four drives per SMI output are detected, the actuator will initiate the functions *Safety* and *Alarm*. No telegrams via the KNX are carried out. Manual operation via the manual buttons on the front of the device remains possible.

## 3.2.6 Parameter window *Output A - D*

In this parameter window, the general settings for outputs A – D are undertaken.

General	Operating mode	Blinds
Manual	Rotation angle of motor shaft for a complete louvre adjustment 10..500	300
EIB/KNX	Number of louvre adjustments 1..250	7
Weather	Position of louvre after move-down [%] 0..100	100
SMI drives	Limit travelling range	no
<b>Output A - D</b>		
Safety		
Status		
Position		
Position 1-4		
Auto 1		
Output A-D scene		

### Operating mode

Options: Blinds  
Shutter

This parameter defines the operating mode of the output. The communication objects and the parameters for the respective outputs differ slightly, depending on the operation mode.

- *Blinds*: Particularly suitable for the control of blinds with the functions Move UP/DOWN and STOP/Louvre adjustment.

#### Note

The parameters as well as the communication objects for louvre adjustment are available exclusively in the operating mode *Blinds*.

- *Shutter*: Particularly suitable for control of shutters, awnings, roller blinds and other shutters/blinds with the functions *Move UP/DOWN* and *STOP* as well as the control of doors and windows.

## Rotation angle of motor shaft for a complete louvre adjustment 10..500

Options: 10...300...500

This parameter defines the angle of rotation of the motor shaft (shutter/blind shaft) for a complete adjustment of the louvre. This angle is the basis for the calculation of the number of louvre adjustments (steps), which are necessary to move the shutter/blind from fully open to fully closed in steps.

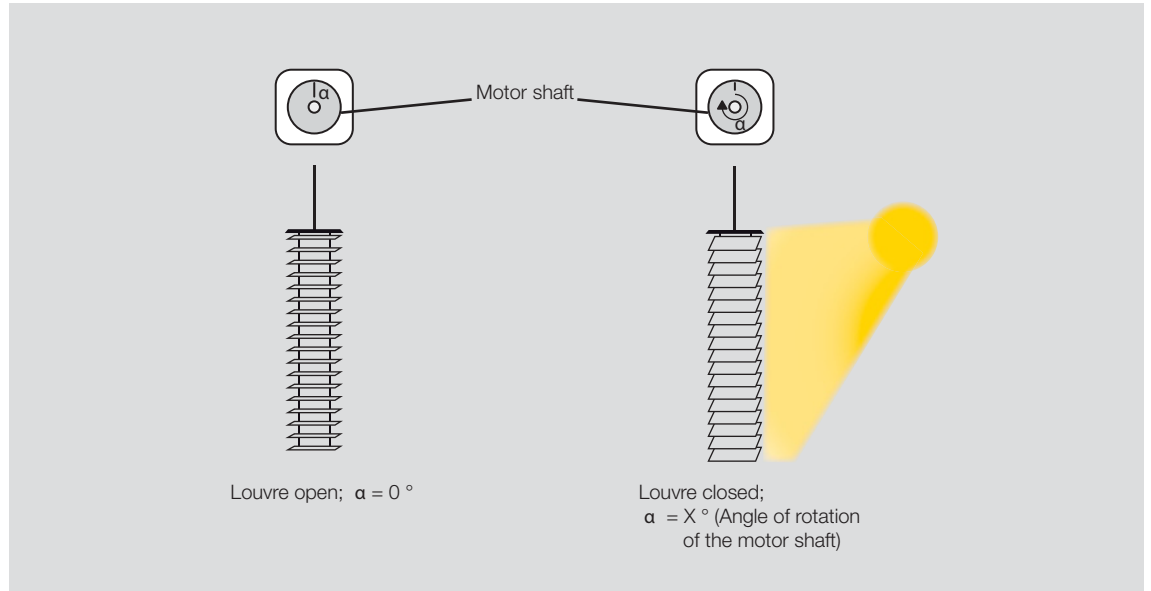

The angle of rotation of the motor shaft for a complete adjustment of the louvre is dependent on the corresponding shutter/blind type and can be queried by the manufacturer or the blind fabricator.

Alternatively, the angle of rotation can also be determined during commissioning. Proceed as follows:

1. For the maximum angle of rotation, a value of  $360^\circ$  is initially assumed in the parameter *Rotation angle of motor shaft for a complete louvre adjustment*.
2. The number of louvre settings in the parameter of the same name is set to 36. Thus a resolution of  $10^\circ$  per louvre stop results.
3. The value of the parameter *Position of louvre after move-down [%] 0..100* must be set to be completed at 100% (default factory setting). The actuator must now be programmed or loaded with these settings.
4. After this process, the shutter/blinds must be moved manually to the DOWN end position via manual control on the actuator.
5. Now the shutter/blind is fully opened manually with individual step telegrams using manual control. The number of step telegrams necessary must be counted.

6. The maximum angle of rotation of the motor shaft can now be calculated:

Angle of rotation = counted step telegrams x 10°

Example
---------

28 step telegrams x 10° = 280°
--------------------------------

7. This value must now be entered in the parameter *Rotation angle of motor shaft for a complete louvre adjustment*.
8. Now the value of the parameter *Number of louvre adjustments* can be selected between 1 and 250.

Note
------

SMI enables the smallest possible angle of rotation per step telegram of 2° on the motor shaft.
-------------------------------------------------------------------------------------------------

### Number of louvre adjustments 1..250

Options: 1...7...250

This parameter defines the number of steps to be completed (short button push), in order to tilt the louvres from fully open to fully closed. First of all the angle of rotation of the motor shaft for a complete louvre adjustment must be determined (see parameter *Rotation angle of motor shaft for a complete louvre adjustment* 10..500).

### Position of louvre after move-down [%]

0..100

Options: 0...100

The louvres are initially closed after a DOWN movement to the lower end position. Thereafter, travel to the parameterized louvre position is undertaken.

The same louvre position is also set if the lower limit is reached after a limited DOWN travel movement.

- 0: Louvre open
- ...: Intermediate position
- 100: Louvre closed

Note
------

This position is only moved to in conjunction with a movement telegram in the communication objects <i>Move blinds Up-Down</i> and <i>Blinds Up-Down limited</i> as well as in conjunction with a manual down movement. It is not moved, for example, due to a travel action based on forced operation!
---------------------------------------------------------------------------------------------------------------------------------------------------------------------------------------------------------------------------------------------------------------------------------------------------------

## Limit travelling range

Options:    yes  
              no

For certain applications, the travelling range of the shutter/blind can be limited for the user. Opening and closing of the skylights can, for example, be limited to a certain group of users to a range of 0...20% opening, whereas the caretaker may operate the complete range of movement.

- *yes*: The communication object *Blinds Up-Down limited* as well as the parameters *Upper limit* and *Lower limit* appear.

### Note

The movement range limitation only functions via the *Blinds Up-Down limited* object. The limits of the parameters *Upper limit* and *Lower limit* do not apply to all other communication objects.

## Upper limit [%] 0..100

## Lower limit [%] 0..100

Options:    0...100

This parameter defines the upper and lower limit of the travel range.

- *0*: Upper limit
- *...*: Intermediate position
- *100*: Lower limit

## 3.2.7 Parameter window *Safety*

In this parameter window, the settings for the function *Safety* are undertaken.

General	Output reacts on communication object for wind alarm no.	Output does not react to wind alarm
Manual	Position on wind alarm	deactivated
EIB/KNX	Position on rain alarm	deactivated
Weather	Position on frost alarm	deactivated
SMI drives	Disable via communication object	deactivated
Output A - D	Forced operation	deactivated
<b>Safety</b>	Position on reset of weather alarm, blocking and forced operation	no reaction
Status	Order of priority for safety alarm functions	1.Weather alarm - 2.Block - 3.Forced Operation
Position		
Position 1-4		
Auto 1		
Output A-D scene		

### Output reacts on communication object for wind alarm no.

Options: Output does not react to wind alarm  
1/ 2/ 3/ 1+2/ 1+3/ 2+3/ 1+2+3

This parameter determines the wind alarm communication objects to which the output reacts. The values of the assigned communication objects are linked by a logic OR.

### Position on wind alarm

### Position on rain alarm

### Position on frost alarm

Options:      activated - no reaction  
                  activated – up  
                  activated – down  
                  activated – stop  
                  deactivated

This parameter defines the position of the shutter/blind when a weather alarm (wind, rain, frost) is received. The shutter/blind can no longer be operated via other communication objects or even by manual operation, until the weather alarm has been rescinded.

- *activated - no reaction*: If the shutter/blind is performing a movement, this travel action to the target position is carried out. If the shutter/blind is at rest, it will remain in its position unchanged.
- *activated – up*: The shutter/blind moves UP, after a weather alarm is received.
- *activated – down*: The shutter/blind moves DOWN, after a weather alarm is received.
- *activated – stop*: If the shutter/blind is performing a movement, this movement stops immediately. If the shutter/blind is at rest, it will remain in its position unchanged.

## Disable via communication object

Options:    deactivated  
              activated

This parameter enables the function *Block*. The shutter/blind moves, e.g. to a parameterized position, or the operation is blocked. Example: The operation of an internal shutter/blind (internal blind or roller blind) is inhibited if the window is open.

- *activated*: The communication object *Block* is enabled. The following parameter appears.

### Position during blocking

Options:    no reaction  
              UP  
              DOWN  
              STOP  
              Position 1...4

This parameter determines the position to be travelled to for function *Block*.

- *no reaction*: If the shutter/blind is performing a movement, this travel action to the target position is carried out. If the shutter/blind is at rest, it will remain in its position unchanged.
- *Up or down*: The shutter/blind moves UP or DOWN.
- *STOP*: If the shutter/blind is performing a movement, this movement stops immediately. The outputs are disconnected from the voltage supply. If the shutter/blind is at rest, it will remain in its position unchanged.

## Forced operation

Options:    deactivated  
              activated

With the function *Forced operation*, the shutter/blind can be moved up or down via a 2 bit telegram, and the operation can be blocked. For example, the function *Forced operation* can be used to move blinds upwards if the windows are being cleaned or moved downwards if the louvres are being cleaned. At the same time, the operation of the shutter/blind is blocked to ensure that the cleaning personnel are not endangered by an unexpected movement.

- *activated*: The communication object *Forced operation* is enabled.

### Position on reset of weather alarm, blocking and forced operation

Options:    no reaction  
              UP  
              DOWN  
              STOP  
              Position 1...4  
              according to object value

This parameter determines the shutter/blind position when rescinding a weather alarm, blocking or a forced operation.

- *no reaction*: If the shutter/blind is performing a movement, this movement action to the target position is carried out. If the shutter/blind is at rest, it will remain in its position unchanged.
- *UP*: The shutter/blind moves UP after a safety function is rescinded.

- *DOWN*: The shutter/blind moves DOWN after a safety function is rescinded.
- *STOP*: If the shutter/blind is performing a movement, this movement stops immediately. If the shutter/blind is at rest, it will remain in its position unchanged.
- *Position 1...4*: If one of these positions are selected, the shutter/blind moves to a preset position. The shutter/blind height and louvre setting of the respective position are set in [Parameter window Position 1-4](#), page 43.
- *According to object value*: During a safety alarm, the incoming KNX telegrams are saved on direct communication objects. The status of the actuator is updated to correspond to the current values of the communication objects, e.g. automatic control is activated. If no new telegrams have been received in the meantime, the shutter/blind is moved to the position in which it was when the safety alarm occurred. With this parameter setting, incoming telegrams are saved on the following communication objects:
  - *Move blinds Up-Down*
  - *Blinds Up-Down limited*
  - *Move to position 0..255*
  - *Move louvre 0..255*
  - *Move to position 1/2*
  - *Move to position 3/4*

#### Order of priority for safety alarm functions

- Options:
- 1. Weather alarm - 2. Block - 3. Forced operation
  - 1. Weather alarm - 2. Forced operation - 3. Block
  - 1. Block - 2. Weather alarm - 3. Forced operation
  - 1. Block - 2. Forced operation - 3. Weather alarm
  - 1. Forced operation - 2. Block - 3. Weather alarm
  - 1. Forced operation - 2. Weather alarm - 3. Block

This parameter determines the sequence of priorities for the safety functions *Weather alarms* (wind, rain, frost), *Block* and *Forced operation*. These functions have a higher priority than all other functions. If one of these functions is activated, the operation of the shutter/blind is inhibited. This also applies during manual operation.

A priority must also be defined for safety priorities among one another. In this way, the shutter/blind is correctly controlled if more than one security function is activated simultaneously. Forced operation, for example, has priority over a wind alarm when cleaning the windows, so that the cleaning personnel are not hindered by an UP telegram resulting from a wind alarm.

#### Note

Wind, rain and frost alarm are only activated if in parameter window *Weather*, the communication objects are enabled and linked to the group addresses!



## 3.2.8

### Parameter window *Status*

In this parameter window, the status messages are defined.

General	Send position: 0..255	no
Manual	Send position: limit position reached	no
EIB/KNX	Send status of operation	no
Weather	Send status of automatic control	no
SMI drives	Send status byte	no
Output A - D	Send status SMI failure	no
Safety	Send status number of SMI drives	no
<b>Status</b>	Send SMI diagnostic byte	no
Position		
Position 1-4		
Auto 1		
Output A-D scene		

(The status is always sent after a change of value.)

#### Send position: 0...255

Options:    yes  
              no

The actuator sends the relative position of the shutter/blinds and the position of the louvres to two separate communication objects each as a 1 byte value (0...255).

The following applies for the position of the shutter/blinds: The value 0 corresponds to the position top/upper (0 %). The value 255 corresponds to the position bottom/lower (100 %).

The following applies for the position of the louvres: The value 0 corresponds to the louvre position opened (0 %). The value 255 corresponds to the louvre position closed (100 %).

#### Note

The parameters as well as the communication objects for louvre adjustment are available exclusively in the operating mode *Blinds*.

- yes: The communication objects *Telegr. status of position 0..255* and *Telegr. status louvre 0..255* (only in *Blinds* mode) are enabled.

#### Send position: limit position reached

Options:    yes  
              no

The actuator sends the information if the shutter/blinds are in the upper or lower end limit to two separate communication objects (each 1 bit). If the information is sent to both communication objects stating that the respective end position is not reached, the shutter/blinds are in an intermediate position.

This function is particularly suitable for further logic in order to mutually interlock the outputs to one another. For example, the awnings may not move if the window is opened and the window may also not be opened by a drive if the awning is extended.

- yes: The communication objects *Telegr. status of upper pos.* and *Telegr. status of lower pos.* are enabled

## Send status of operation

Options:    yes  
              no

During a weather alarm, a block telegram or a forced operation, the operation of the shutter/blind is disabled. Even when manual operation is activated via the *Man.* button, the shutter/blind cannot be operated via KNX.

This function is particularly suitable to indicate to the user via an LED that the shutter/blinds cannot be moved to the upper or lower end position and that automatic control cannot be activated.

- *yes*: The communication object *Telegr. status of operation* is enabled.

## Send status of automatic control

Options:    yes  
              no

The actuator sends information on whether the automatic control is activated or deactivated (1 bit).

This function is particularly suitable to indicate to the user via an LED if the automatic control is activated.

- *yes*: The communication object *Telegr. status of aut. control* is enabled.

## Send status byte

Options:    yes  
              no

The drives connected to the actuator can be operated via several special functions. A wind alarm can inhibit operation or the automatic control is activated or manual operation is switched on. The status byte provides exact information, in which the following function types indicate how an output of the actuator, is controlled:

- *Automatic sun protection*
- *Heating / cooling automatic*
- *Wind alarm*
- *Rain alarm*
- *Frost alarm*
- *Forced operation*
- *Block*
- *Manual operation*

This function is particularly suitable to analyse the reaction of the actuator to an incoming telegram during commissioning or trouble shooting.

- *yes*: The communication object *Telegr. status byte* is enabled.

## Send status SMI failure

Options:    yes  
              no

If a drive is defective, no longer connected or is currently being programmed, the actuator will not receive an acknowledgement via the SMI when undertaking a travel motion. In this case, it will send an error message via the communication object *Telegr. status SMI failure*.

- yes: The communication object *Telegr. status SMI failure* is enabled.

### Note

If multiple drives are wired in parallel with one output, only the failure of all drives will be detected and indicated as an SMI failure. A message will not be issued, as long as at least one drive continues to acknowledge its travel actions.

The communication object *Telegr. status SMI failure* is also sent if the 230 V auxiliary voltage fails.

## Send status number of SMI drives

Options:    yes  
              no

If the number of parameterized drives differs from the number of connected drives per channel, the actuator sends an error message via the communication object *Telegr. status number of drives*.

- yes: The communication object *Telegr. status number of drives* is displayed.

### Note

If more than four drives are connected to a channel, the actuator will only carry out alarm and safety functions. No telegrams via the KNX are carried out. Operation of the manual buttons on the front of the device is still possible.

## Send SMI diagnostic byte

Options:    yes  
              no

Using this communication object, the actuator sends current information concerning the connected SMI drives to the KNX.

- More than 4 drives detected on SMI
- Less drives detected than configured
- At least one drive cannot be identified via its ID
- Short-circuit on SMI (hardware fault)
- Motor fault
- Motor moves DOWN
- Motor moves UP
- No communication

This function is particularly suitable to analyse the reaction of the drive to an incoming telegram during commissioning or trouble shooting.

- yes: The communication object *Telegr. diagnostic byte* is enabled.

## 3.2.9 Parameter window *Position*

In this parameter window, the communication objects for the function *Preset* are enabled.



### Move to position 0...255

Options: deactivated  
activated

The shutter/blind can be moved to any desired position, and the louvres can be positioned at any desired angle via two separate communications objects.

This is suitable particularly for central telegrams, if all shutters/blinds on a facade have to be moved to the same position.

- *activated*: The 1 byte communication objects *Move to position 0..255* and *Move louvre 0..255* are enabled.

### Move to position 1 bit preset

Options: deactivated  
activated

Up to 4 preset positions can be set for each output. Each of these 4 preset positions can be recalled via a 1 bit telegram. The shutter/blind is moved to the saved position and assumes the saved louvre setting.

This function is suitable particularly for repeated movement to preferred shutter/blind positions, e.g. by pressing a button or for integration in a scene, which is accessed via a 1 bit telegram.

The saved preset positions can be very easily changed without programming the actuator via the KNX. The shutter/blinds must simply be brought to the new required target position. The new position is adopted via a 1 bit telegram as a new preset position into the memory of the device.

Recalling and saving a preset position can be undertaken with a single button if, for example, a position is accessed with a short button push and the current position is saved as the new preset position with a long button push.

- *activated*: The communication objects *Move to position 1/2*, *Move to position 2/4*, *Set position 1/2* and *Set position 3/4* are enabled.

## 3.2.10

### Parameter window *Position 1-4*

In this parameter window, the four preset positions are defined.

<ul style="list-style-type: none"> <li>General</li> <li>Manual</li> <li>EIB/KNX</li> <li>Weather</li> <li>SMI drives</li> <li>Output A - D</li> <li>Safety</li> <li>Status</li> <li>Position</li> <li><b>Position 1-4</b></li> <li>Auto 1</li> <li>Output A-D scene</li> </ul>	<p>Overwrite preset values during download <input type="text" value="yes"/></p> <p>Position 1 [%] 0..100 (0% = top; 100% = bottom) <input type="text" value="20"/></p> <p>Louvre 1 [%] 0..100 (0% = opened; 100% = closed) <input type="text" value="20"/></p> <p>Position 2 [%] 0..100 (0% = top; 100% = bottom) <input type="text" value="40"/></p> <p>Louvre 2 [%] 0..100 (0% = opened; 100% = closed) <input type="text" value="40"/></p> <p>Position 3 [%] 0..100 (0% = top; 100% = bottom) <input type="text" value="60"/></p> <p>Louvre 3 [%] 0..100 (0% = opened; 100% = closed) <input type="text" value="60"/></p> <p>Position 4 [%] 0..100 (0% = top; 100% = bottom) <input type="text" value="80"/></p> <p>Louvre 4 [%] 0..100 (0% = opened; 100% = closed) <input type="text" value="80"/></p>
--------------------------------------------------------------------------------------------------------------------------------------------------------------------------------------------------------------------------------------------------------------------------------	---------------------------------------------------------------------------------------------------------------------------------------------------------------------------------------------------------------------------------------------------------------------------------------------------------------------------------------------------------------------------------------------------------------------------------------------------------------------------------------------------------------------------------------------------------------------------------------------------------------------------------------------------------------------------------------------------------------------------------------------------------------------------------------------------------------------------------------------

#### Overwrite preset values during download

Options: yes  
no

The saved preset positions can be reset via a telegram without the need to program them. The users can thus set the preset positions to suit their specific requirements.

These individual preset positions should also generally remain saved, if the programming of the actuator is changed by a download. With this parameter, you can set if the saved preset values are overwritten during a download by the parameterised preset values.

- **yes:** The parameters *Position X* and *Louvre X* are displayed.

#### Note

If individual preset values have been set during ongoing operation by a user, the parameter should then be set to *no* to ensure that the individual positions are retained.

# ABB i-bus<sup>®</sup> KNX Commissioning

**Position X [%] 0...100**  
(0 % = top; 100 % = bottom)

**Louvre X [%] 0...100**  
(0 % = opened; 100 % = closed)

X = 1...4

Options: 0...20...40...60...80...100

With this parameter, the preset position (position and louvre setting) is set.

- 0: Position UP, louvre opened
- 1...99: Intermediate positions.
- 100: Position DOWN, louvre closed

Note
The parameters for louvre adjustment are available exclusively in the operating mode <i>Blinds</i> .

## 3.2.11

### Parameter window *Auto 1*

In this parameter window, all settings for the sun automatic control are undertaken.

General	Use sun automatic control	yes
Manual	Deactivation of automatic control	via object "activation" and move command
EIB/KNX	Automatic reactivation of automatic control	deactivated
Weather	Toggling to automatic control	enabled
SMI drives	Toggling to direct control	enabled
Output A - D	Position for sun = "1" (sun)	DOWN
Safety	Position for sun = "0" (no sun)	UP
Status	Delay for presence = "1" [s] 0..6,000	0
Position	Delay for presence = "0" [s] 0..6,000	0
Position 1-4		
Auto 1		
Auto 2		
Output A-D scene		

#### Use sun automatic control

Options:     no  
              yes

This parameter enables the *Use sun automatic control* feature.

Together with other KNX components, a very comfortable sun automatic control can be established. This automatic control is activated individually for every output and controls the shutter/blind according to the intensity of the sun's rays. The shutter/blind is moved automatically to the ideal position providing shade in accordance with the intensity and direction from which the sun is shining.

For example, the blinds can be moved upwards if the sunshine is very weak or if the window concerned is in the shadows. Accordingly, the room receives as much light as possible without needing to be subject to direct sunshine.

- *yes*: The communication objects *Activation of aut. Control* and *Sun* as well as the parameters of the parameter window *Auto 1* and the parameter window *Auto 2* appear.

#### Note

There are **direct** communication objects:

- *Move shutter UP/DOWN*
- *Louvre adj./ Stop Up-Down*
- *Shutter UP/DOWN limited*
- *Move to position 0..255*
- *Move louvre 0..255*
- *Move to position 1/2*
- *Move to position 3/4*
- *Scene*

If travel detection or a reference movement is triggered during active automatic control, it will be undertaken.

## Deactivation of automatic control

Options:     via object "activation"  
              via object "activation" and move command

The actuator only observes incoming telegrams for the sun automatic control communication objects if automatic control has been activated. The automatic control is activated by a telegram with the value 1 on the communication object *Activation of aut. Control*.

The automatic control is deactivated by a telegram with the value 0 on the same communication object. With this parameter, you set if the automatic control is also deactivated via a travel telegram, e.g. by an UP or DOWN telegram.

- *via object "activation"*: The automatic control is activated and deactivated exclusively by a telegram to the communication object *Activation of aut. Control*. If automatic control is activated, the incoming telegrams to the direct communication objects are not carried out. After deactivation of automatic control, the shutter/blind remains in its current position and can be controlled again via direct communication objects.
- *via object "Activation" and move command*: Incoming telegrams to direct communication objects lead to deactivation of automatic control and are carried out immediately. This option is particularly suitable for the case when automatic is activated via a central telegram and is to be deactivated again without additional button operations. The following parameter appears:

### Automatic reactivation of automatic control

Options:     deactivated  
              activated

If the automatic control is deactivated via one of the direct communication objects, it is possible to reactivate automatic control automatically after a parameterized time.

- *activated*: The following parameter appears.

### Time to reactivate automatic control automatically [min.] 10...6.000

Options:     10...300...6,000

Note
A change of the parameter value will only become active after the next deactivation of automatic control by a direct communication object.

## Toggling to automatic control Toggling to direct control

Options:     enabled:  
              via object enable/ disable

This parameter determines how the toggling to automatic control and/or enabling of direct control or whether enable/disable via an additional communication object is undertaken.

- *via object enable/ disable*: The communication objects *Enable/disable automatic* and *Enable/ /block direct control* are enabled.



# ABB i-bus<sup>®</sup> KNX Commissioning

## Position for sun = "1" (sun)

Options:      no reaction  
                 UP  
                 DOWN  
                 STOP  
                 Position 1...4  
                 Receive position and louvre via object<sup>1</sup>  
                 Receive only louvre via object<sup>1</sup>  
                 Receive position via object<sup>2</sup>

<sup>1</sup> only in operation mode Blinds

<sup>2</sup> only in operation mode Shutter

This parameter is used to set the response with communication object *Sun = 1 (sun)* in automatic operation.

- *no reaction*: Any movement currently being undertaken is completed.
- *UP or DOWN*: The shutter/blind moves up or down when the sun shines.
- *STOP*: Any movement currently being undertaken by the shutter/blind is stopped immediately. The outputs are disconnected from the voltage supply.
- *Position 1...4*: If one of these positions are selected, the shutter/blind moves to a preset position. The shutter/blind height and louvre setting of the respective position are set in [Parameter window Position 1-4](#), page 43.
- *Receive position and louvre via object*: This option is suitable particularly in conjunction with the Shutter Control Unit JSB/S.

### Note

This option is available exclusively in the *Blinds* operation mode.

- *Receive only louvre via object*: With activated automatic function and sun = 1, only the value on the communication object *Sun: Adjust louvre for sun 0..255* is evaluated.

### Note

This option is available exclusively in the *Blinds* operation mode.

### Note

A louvre adjustment is not carried out if the shutter/blind is in its upper end position.

- *receive position via object*: The position of the shutter/blind is received via the communication object *Sun: Adjust louvres for sun 0..255* is received.

### Note

This option is available exclusively in the *Shutter* operation mode.

## Position for sun = "0" (no sun)

Options:      no reaction  
                 UP  
                 DOWN  
                 STOP  
                 Position 1...4  
                 same as sun = '1'

This parameter is used to set the response with communication object *Sun = 0 (no sun)* in automatic operation.

- *no reaction*: Any movement currently being undertaken is completed.
- *UP or DOWN*: The shutter/blind moves up or down when the sun shines.
- *STOP*: Any movement currently being undertaken by the shutter/blind is stopped immediately. The outputs are disconnected from the voltage supply.
- *Position 1...4*: If one of these positions are selected, the shutter/blind moves to a preset position. The shutter/blind height and louvre setting of the respective position are set in [Parameter window Position 1-4](#), page 43.
- *same as sun = '1'*: The shutter/blind moves in accordance with the setting of the parameter *Position for sun = '1'*.

## Delay for sun = "1" [s] 0...6,000

## Delay for sun = "0" [s] 0...6,000

Options:      0...6,000

This parameter defines the reaction to the communication object *Sun*.

### Note

If in parameter window *General*, a time has been entered in the parameter *Time-delayed switching of drives*, this time must be added to the delay times at sun = 1 or 0.

The delay times can also be set in the brightness sensor and in the shutter module. It must be noted that the delay times can add up in this way.

## 3.2.12

### Parameter window *Auto 2*

In this parameter window, all settings for the heating/cooling automatic control are undertaken.

<ul style="list-style-type: none"> <li>General</li> <li>Manual</li> <li>EIB/KNX</li> <li>Weather</li> <li>SMI drives</li> <li>Output A - D</li> <li>Safety</li> <li>Status</li> <li>Position</li> <li>Position 1-4</li> <li>Auto 1</li> <li><b>Auto 2</b></li> <li>Output A-D scene</li> </ul>	<p>Heating/Cooling automatic control <span style="float: right;">activated ▾</span></p> <p>Delay for presence = "1" [s] 0..6,000 <span style="float: right;">0</span></p> <p>Delay for presence = "0" [s] 0..6,000 <span style="float: right;">600</span></p> <p>Position for heating = "1" and sun = "1" <span style="float: right;">UP ▾</span></p> <p>Position for heating = "1" and sun = "0" <span style="float: right;">no reaction ▾</span></p> <p>Position for cooling= "1" and sun = "1" <span style="float: right;">DOWN ▾</span></p> <p>Position for cooling= "1" and sun = "0" <span style="float: right;">no reaction ▾</span></p> <p>On heating="1" and cooling="1" or on heating="0" and cooling="0" the output is controlled only by- sun automatic control</p>
------------------------------------------------------------------------------------------------------------------------------------------------------------------------------------------------------------------------------------------------------------------------------------------------	---------------------------------------------------------------------------------------------------------------------------------------------------------------------------------------------------------------------------------------------------------------------------------------------------------------------------------------------------------------------------------------------------------------------------------------------------------------------------------------------------------------------------------------------------------------------------------------------------------------------------------------------------------------------------------------------------------------------------------------------------------------------------------------------

#### Heating/Cooling automatic control

Options:     deactivated  
              activated

This parameter enables heating/cooling automatic control.

The Heating/Cooling automatic control controls the shutter/blinds according to the sun's rays and the required energy input requirement into the room. The shutter/blind is moved to the ideal shadowing position to ensure optimum heating/cooling.

Thus, for example, the blind can be opened during the heating phase of the sun to provide additional warmth to the room, and at night the textile inner blind can be lowered to reduce cooling of the room. On the other hand, the shutters/blinds can be moved down during the cooling phase to avoid additional heating of the room.

- *activated*: The communication objects *Heating*, *Cooling* and *Presence* are enabled. The following parameters appear:

**Delay for presence = "1" [s]**  
**0...6,000**

**Delay for presence = "0" [s]**  
**0...6,000**

Options:     0...6,000  
              0 (Delay for presence = "1")  
              600 (Delay for presence = "0")

**Position for heating = "1" and sun = "1"**

**Position for heating = "1" and sun = "0"**

**Position for cooling = "1" and sun = "1"**

**Position for cooling = "1" and sun = "0"**

Options:     no reaction (with Sun = "0")  
              UP (with heating = "1" and sun = "1")  
              DOWN (with cooling = "1" and sun = "1")  
              STOP  
              Position 1...4

This parameter sets the response with sun = 1 (sun) or with sun = 0 (no sun) during the heating/cooling phase.

The phases HEATING = 1 or COOLING = 1 can, for example, be triggered by an external temperature sensor, room thermostat or by a yearly clock timer.

If both the HEATING and COOLING operations are activated simultaneously or none of both operation modes are activated, this is an undefined state. The shutter/blinds are automatically controlled until then using sun automatic control.

**Example external temperature sensor:**

Heating phase: under 10 °C

Cooling phase: above 20 °C

**Example yearly clock timer:**

Heating phase: November - March

Cooling phase: June - August

If both heating operation and cooling operation are simultaneously activated or none of the operating modes are activated, then the heating/cooling automatic control is deactivated, until one defined state (heating or cooling operation) is in operation. The shutters/blinds are automatically controlled until then using sun automatic control.

Note
If the system should only use heating/cooling automatic, the communication object <i>Presence</i> may not be linked with a group address. Accordingly, the communication object automatically has the default value 0. Thus heating/cooling automatic is immediately activated via the communication object <i>Activation of aut. Control</i> , which is automatically activated.

## 3.2.13

### Parameter window *Output A-D Scene*

In this parameter window, the function *Scene* is enabled.

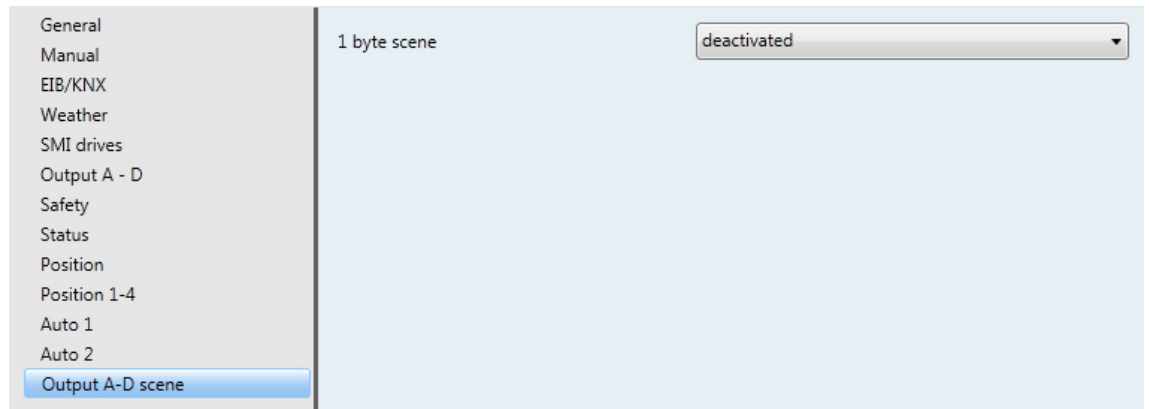

#### 1 byte scene

Options:     deactivated  
              activated

- *activated*: The parameter windows *A: Scene*, *B: Scene*, *C: Scene*, *D: Scene* appear.
- In this parameter window, all settings for the 8 bit scene are undertaken. Each output can be allocated to up to 10 different scenes.

## 3.2.14 Parameter window A-D Scene

In this parameter window, all settings for the 8 bit scene are undertaken. Each output can be allocated to up to 10 different scenes.

General	Scene assignment (1)	no assignment
Manual	Scene assignment (2)	no assignment
EIB/KNX	Scene assignment (3)	no assignment
Weather	Scene assignment (4)	no assignment
SMI drives	Scene assignment (5)	no assignment
Output A - D	Scene assignment (6)	no assignment
Safety	Scene assignment (7)	no assignment
Status	Scene assignment (8)	no assignment
Position	Scene assignment (9)	no assignment
Position 1-4	Scene assignment (10)	no assignment
Auto 1		
Auto 2		
Output A-D scene		
<b>A: Scene</b>		
B: Scene		
C: Scene		
D: Scene		

### Scene assignment (1)

...

### Scene assignment (10)

Options: no assignment  
Scene 1 ... Scene 64:

With the scene function, up to 64 different scenes are managed via a single group address. With this group address, all slaves, who are integrated into a scene, are linked via a 1 byte communication object. The following information is contained in a telegram:

- Number of the scene (1...64) as well as
- Telegram: *Call scene* or *Save scene*.

Each shutter/blind can be integrated in up to 10 scenes. In total, up to 40 scene assignments are possible for the entire device. Thus, for example, all roller blinds can be opened in the morning via a scene and closed in the evenings or shutters/blinds can be integrated into light scenes.

If a telegram is received on the communication object *Scene*, all outputs assigned to the sent scene number will then move to the saved scene position or the current position will be saved as a new scene position.

## Example

The first three outputs of the actuator are assigned to the following scenes. The preset values have been saved with the last corresponding setting of the scenes.

Output	Scene No.	Preset position	Preset louvre
A	5	20 %	50 %
A	9	47 %	30 %
A	45	70 %	80 %
B	5	20 %	50 %
B	37	82 %	65 %
B	45	75 %	31 %
B	78	65 %	77 %
C	10	80 %	-

If scene No. 5 is now recalled, the blinds on outputs A and B will move to the saved preset positions and align the louvres in accordance with the saved preset value. The roller blind on output C is not assigned to scene No. 5 and will therefore not move.

If however, scene 10 is recalled, only the roller blind on output C will move to the saved preset position. As output C in this example is operated in the *Shutter* mode, the subsequent alignment of the louvres is not undertaken.

If the telegram *recall scene no. 5* to the position 20 % / 50 % has been undertaken last on output A, and the user now wishes to use this position as the new preset value for scene no. 45, then the request *Save scene* as well as the no. 45 are sent with the push of a button via the KNX. The shutter/blind does not move. The current position is now saved as the new preset value for scene no. 45 (see the table below) and used the next time the scene is recalled.

Output	Scene No.	Preset position	Preset louvre
A	5	20 %	50 %
A	9	47 %	30 %
A	45	20 %	50 %

## Benefits

The 1 byte scene offers a few advantages in comparison to conventional scene programming. On the one hand, only a single telegram, which is received by all participants in the scene and implemented accordingly, is sent on the bus to retrieve a scene. The target position is saved in the actuator and does not need to be transferred via the KNX with each recall. Only one group address is required for up to 64 scenes. This simplifies the engineering involved and reduces the bus load.

## Reaction on bus voltage failure and programming

The saved scene values are retained with the bus voltage failure, as is the case if only the parameters are loaded when programming.

If the complete application must be reloaded during programming, then the scene value is reset to the position *right at the top*, i.e. preset position = 0 % and preset louvres = 0 %.

## 3.3 Communication objects

### 3.3.1 Brief overview of the communication objects

CO No.	Function	Name	Data Point Type (DPT)	Length	Flags				
					C	R	W	T	A
1	Move blinds Up-Down	Output A	1.008	1 bit	x		x		
	Move shutter Up-Down	Output A	1.008	1 bit	x		x		
2	Louvre adjustment/STOP	Output A	1.008	1 bit	x		x		
	STOP	Output A	1.008	1 bit	x		x		
3	Blinds Up-Down limited	Output A	1.008	1 bit	x		x		
	Shutter Up-Down limited	Output A	1.008	1 bit	x		x		
4	Move to position 0..255	Output A	5.001	1 byte	x		x		
5	Move louvre 0..255	Output A	5.001	1 byte	x		x		
6	Move to position 1/2	Output A	1.006	1 bit	x		x		
7	Move to position 3/4	Output A	1.006	1 bit	x		x		
8	Set position 1/2	Output A	1.006	1 bit	x		x		
9	Set position 3/4	Output A	1.006	1 bit	x		x		
10	Activation of aut. control	Output A	1.011	1 bit	x		x	x	x
11	Sun	Output A	1.001	1 bit	x		x	x	x
12	Move to pos. for sun 0..255	Output A	5.001	1 byte	x		x	x	x
13	Adjust louvres for sun 0...255	Output A	5.001	1 byte	x		x	x	x
14	Presence	Output A	1.002	1 bit	x		x	x	x
15	Heating	Output A	1.011	1 bit	x		x	x	x
16	Cooling	Output A	1.011	1 bit	x		x	x	x
17	Enable/disable automatic	Output A	1.001	1 bit	x		x	x	x
18	Enable / block direct control	Output A	1.001	1 bit	x		x	x	x
19	Block	Output A	1.011	1 bit	x		x		
20	Forced operation	Output A	2.002	2 bit	x		x		
21	Telegr. status position 0...255	Output A	5.001	1 byte	x	x		x	
22	Telegr. status louvre 0...255	Output A	5.001	1 byte	x	x		x	
23	Telegr. Status Position top	Output A	1.008	1 bit	x	x		x	
24	Telegr. Status Position bottom	Output A	1.008	1 bit	x	x		x	
25	Telegr. status of operation	Output A	1.002	1 bit	x	x		x	
26	Telegr. status automatic control	Output A	1.011	1 bit	x	x		x	
27	Telegr. Status byte	Output A	6.020	1 byte	x	x		x	
28	Telegr. status SMI failure	Output A	1.011	1 bit	x	x		x	
29	Telegr. status number of drives	Output A	1.011	1 bit	x	x		x	
30	Telegr. diagnostic byte	Output A	6.020	1 byte	x	x		x	
31...60	The same CO as output A	Output B							
61...90	The same CO as output A	Output C							
91...120	The same CO as output A	Output D							



# ABB i-bus<sup>®</sup> KNX Commissioning

CO No.	Function	Name	Data Point Type (DPT)	Length	Flags				
					C	R	W	T	A
121	Telegr. auxiliary voltage status	Output A...D	1.005	1 bit	x	x		x	
122	Enable/ block manual operation	Output A...D	1.001	1 bit	x		x		
123	Telegr. status of man. operation	Output A...D	1.001	1 bit	x	x		x	
124	Wind alarm No. 1	Output A...D	1.005	1 bit	x		x	x	x
125	Wind alarm No. 2	Output A...D	1.005	1 bit	x		x	x	x
126	Wind alarm No. 3	Output A...D	1.005	1 bit	x		x	x	x
127	Rain alarm	Output A...D	1.005	1 bit	x		x	x	x
128	Frost alarm	Output A...D	1.005	1 bit	x		x	x	x
129	Scene	Output A...D	18.001	8 bit	x		x		
130	Time for automatic reactivation	Output A...D	7.006	2 byte	x		x		
131	Delay time on sun = 1	Output A...D	7.005	2 byte	x		x		
132	Delay time on sun = 0	Output A...D	7.005	2 byte	x		x		
133	Delay for presence = 1	Output A...D	7.005	2 byte	x		x		
134	Delay for presence = 0	Output A...D	7.005	2 byte	x		x		

\* CO = communication object

## 3.3.2

### Communication objects *Output A...D*

No.	Function	Object name	Data type	Flags
1	<b>Move blinds Up-Down</b> (Blinds mode) <b>Move shutter Up-Down</b> (Shutter mode)	<b>Output A</b>	<b>1 bit</b> <b>DPT 1.008</b>	<b>C, W</b>
<p>If a telegram with the value 0 is received on this communication object, the shutter/blind is moved upwards to the rest position or to the end limit position. The shutter/blind stops automatically if the upper or lower end position is reached.</p> <p>Telegram value:    0 = UP                       1 = DOWN</p>				
2	<b>Louvre adjustment /STOP</b> (Blinds mode) <b>STOP</b> (Shutter mode)	<b>Output A</b>	<b>1 bit</b> <b>DPT 1.007</b>	<b>C, W</b>
<p>When a telegram is received (irrespective of whether the value is 0 or 1) on this communication object, the movement is stopped.</p> <p><i>Blinds mode:</i> When the shutter/blind is at rest and a telegram is received on this communication object, a louvre adjustment upwards (0 = OPEN) or downwards (1 = CLOSE) is carried out.</p> <p><i>Shutter mode:</i> When the shutter/blind is at rest and a telegram is received, no action is undertaken.</p> <p>Telegram value:    0 = STOP/louvre adjustment opening                       1 = STOP/louvre adjustment closing</p>				
3	<b>Blinds Up-Down limited</b> (Blinds mode) <b>Shutter Up-Down limited</b> (Shutter mode)	<b>Output A</b>	<b>1 bit</b> <b>DPT 1.008</b>	<b>C, W</b>
<p>This communication object is enabled if in <a href="#">Parameter window Output A - D</a>, page 32, under the parameter <i>Limit travelling range</i> the option <i>yes</i> has been selected.</p> <p>If a telegram with the value 0 is received on this communication object, the shutter/blind will move upwards to the parameterized limit. If a telegram with the value 1 is received, the shutter/blind will move downwards to the parameterized limit. The shutter/blind stops automatically if the parameterized upper or lower limit is reached.</p> <p>Telegram value:    0 = limited UP                       1 = limited DOWN</p>				
4	<b>Move to position 0..255</b>	<b>Output A</b>	<b>1 byte</b> <b>DPT 5.001</b>	<b>C, W</b>
<p>This communication object is enabled if in <a href="#">Parameter window Position</a>, page 42, the parameter <i>Move to position 0..255</i> has been selected with the option <i>activated</i>.</p> <p>If a telegram is received on this communication object, the shutter/blind is moved to the height corresponding to the received value.</p> <p>After the target position is reached, the louvres will assume the same position which they had before the movement started.</p> <p>If a telegram is received during movement on the communication object <i>Move louvre 0..255</i>, then the louvres are set to the corresponding received value after the target position has been reached.</p> <p>Telegram value:    0           = upper                       ...         = intermediate position                       255        = lower</p>				

# ABB i-bus<sup>®</sup> KNX Commissioning

No.	Function	Object name	Data type	Flags		
<b>5</b>	<b>Move louvre 0..255</b> (Blinds mode)	<b>Output A</b>	<b>1 byte</b> <b>DPT 5.001</b>	<b>C, W</b>		
<p>This communication object is enabled if in <a href="#">Parameter window Position</a>, page 42, the parameter <i>Move to position 0..255</i> has been selected with the option <i>activated</i>.</p> <p>If a telegram is received on this communication object, the louvres are then positioned in accordance with the received value. If the shutter/blind is currently moving, the movement will continue to the target position, and positioning of the louvres is then undertaken.</p> <p>Telegram value:    0            = louvre OPEN                           ...            = intermediate position                           255        = louvre CLOSE</p> <table border="1" style="width: 100%;"> <tr> <td style="text-align: center;"><b>Note</b></td> </tr> <tr> <td>This communication object is only available in the <i>Blinds</i> operation mode.</td> </tr> </table>					<b>Note</b>	This communication object is only available in the <i>Blinds</i> operation mode.
<b>Note</b>						
This communication object is only available in the <i>Blinds</i> operation mode.						
<b>6</b>	<b>Move to position 1/2</b>	<b>Output A</b>	<b>1 bit</b>	<b>C, W</b>		
<b>7</b>	<b>Move to position 3/4</b>	<b>Output A</b>	<b>DPT 1.006</b>			
<p>This communication object is enabled, if in <a href="#">Parameter window Position</a>, page 42, the parameter <i>Move to position: 1 bit preset</i> has been selected with the option <i>activated</i>.</p> <p>If a telegram is received on this communication object, then the shutter/blind is moved to the saved preset position. In the <i>Blinds</i> mode, the louvre positioning is undertaken according to the saved preset value, after the position has been reached.</p> <p>If a telegram with the value 0 is received, the movement occurs to position 1 (or position 3); if a telegram with the value 1 is received, the movement occurs to position 2 (or position 4).</p> <p>Telegram value:    0 = move to position 1 or position 3                           1 = move to position 2 or position 4</p>						
<b>8</b>	<b>Set position 1/2</b>	<b>Output A</b>	<b>1 bit</b>	<b>C, W</b>		
<b>9</b>	<b>Set position 3/4</b>	<b>Output A</b>	<b>DPT 1.006</b>			
<p>This communication object is enabled, if in <a href="#">Parameter window Position</a>, page 42, the parameter <i>Move to position: 1 bit preset</i> has been selected with the option <i>activated</i>.</p> <p>If a telegram is received on this communications object, the current position of the shutter/blind is accepted as the new preset value.</p> <p>If a telegram with the value 0 is received, then the current position is saved as the preset value for position 1 (or position 3). If a telegram with the value 1 is received, then the current position is saved as the preset value for position 2 (or position 4). If the positions 1 or 2 are recalled (or positions 3 or 4), you will now move to the new preset values.</p> <p>The changed preset values are retained on a bus voltage failure. With the programming of the actuator, it is possible to set via a parameter if the saved values should be overwritten by the parameterized values.</p> <p>Telegram value:    0 = set position 1 or set position 3                           1 = set position 2 or set position 4</p>						
<b>10</b>	<b>Activation of aut. control</b>	<b>Output A</b>	<b>1 bit</b> <b>DPT 1.011</b>	<b>C, R, T, U</b>		
<p>This communication object is enabled when in <a href="#">Parameter window Auto 1</a>, page 45, the parameter <i>Use sun automatic control</i> has been selected with the option <i>yes</i>.</p> <p>If a telegram with the value 1 is received on this communication object, the automatic control is activated. The output is controlled via the automatic communication objects <i>Sun</i>, <i>Presence</i>, <i>Heating</i> and <i>Cooling</i> as well as <i>Move to pos. for sun 0...255</i> and <i>Adjust louvres for sun 0...255</i>.</p> <p>If a telegram with the value 0 is received, the shutter/blind remains in the current position and no longer reacts to incoming telegrams on the automatic communication objects.</p> <p>Telegram value:    0 = automatic control deactivated                           1 = automatic control activated</p>						

No.	Function	Object name	Data type	Flags
11	<b>Sun</b>	<b>Output A</b>	<b>1 bit</b> <b>DPT 1.001</b>	<b>C, R, T, U</b>
<p>This communication object is enabled when in <a href="#">Parameter window Auto 1</a>, page 45, the parameter <i>Use sun automatic control</i> has been selected with the option <i>yes</i>.</p> <p>Incoming telegrams on this communication object are only considered if automatic control is activated.</p> <p>If a telegram with the value 1 is received on the communications object <i>Sun</i>, the shutter/blind will move to the parameterized position <i>Position for sun = 1</i>. If a telegram with the value 0 is received, the shutter/blind will move to the parameterized position <i>Position for sun = 0</i>.</p> <p>The reaction to incoming telegrams can be delayed in its execution via the parameter <i>Delay for sun= X</i>, in order to avoid that the shutter/blinds continuously move up and down in changeable weather. If a telegram with the opposing value is received within the delay time, the <i>Position for sun = 1</i> is not executed and the shutter/blind remains in the <i>Position for sun = 0</i> or vice versa.</p> <p>If the option <i>receive position via 8 bit value</i> is set as <i>Position for sun = X</i>, the output will move to the position, after the delay has timed out, which was last received on the communication objects <i>I (Mode Blinds and Shutter)</i> as well as <i>Adjust louvres for sun 0..255</i> (only for mode <i>Blinds</i>).</p> <p>Telegram value:     0 = no sun                       1 = sun</p>				
12	<b>Move to pos. for sun 0..255</b>	<b>Output A</b>	<b>1 byte</b> <b>DPT 5.001</b>	<b>C, R, T, U</b>
<p>This communication object is enabled when in <a href="#">Parameter window Auto 1</a>, page 45, the parameter <i>Position for sun = 1 (sun)</i> has been selected with the option <i>Receive position and louvre via object</i>.</p> <p>Incoming telegrams on this communication object are only executed if automatic control is activated and if a 1 has been received on the <i>Sun</i> communications object. The shutter is then positioned to correspond with the received value.</p> <p>Telegram value:     0 = upper                       ... = intermediate position                       255 = lower</p> <p>After the target position is reached, the louvres will assume the same position, which they had before the movement started. If a telegram is received during movement on the communication object <i>Adjust louvres for sun 0..255</i>, then the louvres are set to the corresponding received value after the target position has been reached.</p>				
13	<b>Adjust louvres for sun 0...255</b> <i>(Blinds mode)</i>	<b>Output A</b>	<b>1 byte</b> <b>DPT 5.001</b>	<b>C, R, T, U</b>
<p>This communication object is enabled when in <a href="#">Parameter window Auto 1</a>, page 45, the parameter <i>Position for sun = 1 (sun)</i> has been selected with the option <i>receive only louvre via object</i>.</p> <p>Incoming telegrams on this communication object are only executed if automatic control is activated and if a 1 has been received on the communication object <i>Sun</i>. The louvres are then positioned to correspond with the received value.</p> <p>Telegram value:     0 = louvre fully opened                       ... = intermediate position                       255 = louvre fully closed</p> <p>If the shutter/blind is currently moving, the movement will continue to the target position, and positioning of the louvres is then undertaken.</p>				

# ABB i-bus<sup>®</sup> KNX Commissioning

No.	Function	Object name	Data type	Flags		
<b>14</b>	<b>Presence</b>	<b>Output A</b>	<b>1 bit DPT 1.002</b>	<b>C, R, T, U</b>		
<p>This communication object is enabled when in <a href="#">Parameter window Auto 2</a>, page 49, the parameter <i>Heating/cooling automatic control</i> has been selected with the option <i>activated</i>.</p> <p>Incoming telegrams on this communication object are only considered if automatic control is activated.</p> <p>If a telegram with the value 1 is received on this communication object, the sun automatic control is activated and the shutter/blinds are controlled in accordance with the parameterized <i>Position for sun = X</i>.</p> <p>If a telegram with the value 0 is received on this communication object, then heating/cooling automatic is activated and the shutter/blind is controlled in accordance with the parameterized <i>Position for heating = 1 and sun = X</i> or <i>Position for cooling = 1 and sun = X</i>.</p> <p>The reaction to incoming telegrams can be delayed in its execution via the parameter <i>Delay for presence = X</i>, in order to avoid that the shutter/blinds continuously move up and down, when people enter and leave the room frequently. If a telegram with the opposing value is received within the delay time, the heating/cooling target position is not moved to and the shutter/blind remains in the sun automatic control target position or vice versa.</p> <p>Telegram value:     0 = no one present (→ heating / cooling automatic)                           1 = persons present (→ automatic sun protection)</p> <p>Pay attention to the telegram values with communication objects 15/16 (heating/cooling)!</p> <table border="1" style="width: 100%; border-collapse: collapse;"> <thead> <tr> <th style="background-color: #e0e0e0;">Note</th> </tr> </thead> <tbody> <tr> <td>If heating/cooling automatic control is to be programmed, but no sun automatic control is to be programmed, the communication object <i>Presence</i> has to remain without logical linking. Accordingly, the default value 0 is automatically present in this communication object. Thus heating/cooling automatic control is immediately activated, if automatic has been activated via the communication object <i>Activation of aut. Control</i>.</td> </tr> </tbody> </table>					Note	If heating/cooling automatic control is to be programmed, but no sun automatic control is to be programmed, the communication object <i>Presence</i> has to remain without logical linking. Accordingly, the default value 0 is automatically present in this communication object. Thus heating/cooling automatic control is immediately activated, if automatic has been activated via the communication object <i>Activation of aut. Control</i> .
Note						
If heating/cooling automatic control is to be programmed, but no sun automatic control is to be programmed, the communication object <i>Presence</i> has to remain without logical linking. Accordingly, the default value 0 is automatically present in this communication object. Thus heating/cooling automatic control is immediately activated, if automatic has been activated via the communication object <i>Activation of aut. Control</i> .						
<b>15</b>	<b>Heating</b>	<b>Output A</b>	<b>1 bit</b>	<b>C, R, T, U</b>		
<b>16</b>	<b>Cooling</b>	<b>Output A</b>	<b>DPT 1.011</b>			
<p>This communication object is enabled when in <a href="#">Parameter window Auto 2</a>, page 49, the parameter <i>Heating/cooling automatic control</i> has been selected with the option <i>activated</i>.</p> <p>Incoming telegrams on these communication objects are only executed if automatic control is activated and if a 0 has been received on the <i>Presence</i> communications object.</p> <p>If a telegram with the value 1 is received on the communications object <i>Heating</i>, then the output will move to the parameterized <i>Position for heating = 1 and sun = 1</i> or <i>Position for heating = 1 and sun = 0</i>.</p> <p>If a telegram with the value 1 is received on the communications object <i>Cooling</i>, then the output will move to the parameterized <i>Position for cooling = 1 and sun = 1</i> or <i>Position for cooling = 1 and sun = 0</i>.</p> <p>If both communication objects have last received a 0 or if both have received a 1, then the heating/cooling automatic is deactivated, and the output is controlled via sun automatic control.</p> <p>Telegram value:     0 = do not heat/do not cool                           1 = heating/cooling</p>						
<b>17</b>	<b>Enable/disable automatic</b>	<b>Output A</b>	<b>1 bit DPT 1.001</b>	<b>C, R, T, U</b>		
<p>This communication object is enabled when in <a href="#">Parameter window Auto 1</a>, page 45, the parameter <i>Toggling to automatic control</i> has been selected with the option <i>via object enable/ disable</i>.</p> <p>If a telegram with the value 1 is received on this communication object, the automatic control is deactivated, and the output can only be controlled directly via communication objects. The automatic control can no longer be activated via the communication object <i>Activation of aut. Control</i>.</p> <p>If a telegram with the value 0 is received on this communication object, the automatic control can be reactivated again for the corresponding output.</p> <p>Telegram value:     0 = automatic control enabled                           1 = automatic control disabled</p>						

No.	Function	Object name	Data type	Flags
<b>18</b>	<b>Enable / block direct control</b>	<b>Output A</b>	<b>1 bit DPT 1.001</b>	<b>C, R, T, U</b>
<p>This communication object is enabled when in <a href="#">Parameter window Auto 1</a>, page 45, the parameter <i>Toggle to direct control</i> has been selected with the option <i>via object enable/disable</i>.</p> <p>If a telegram with the value 1 is received on this communication object, the incoming telegrams will not be executed on the communication objects No. 1 to 9.</p> <p>Telegram value:    0 = direct control enabled                       1 = direct control disabled</p>				
<b>19</b>	<b>Block</b>	<b>Output A</b>	<b>1 bit DPT 1.011</b>	<b>C, W</b>
<p>This communication object is enabled when in <a href="#">Parameter window Safety</a>, page 36, the parameter <i>Disable via communication object</i> has been selected with the option <i>activated</i>.</p> <p>If a telegram with the value 1 is received on this communication object, then the shutter/blind is moved to the parameterized <i>Position during blocking</i> and operation is blocked.</p> <p>If a telegram with the value 0 is received after a telegram with the value 1, the shutter/blind is moved to the parameterized <i>Position on reset of weather alarm, blocking and forced operation</i> and operation is re-enabled.</p> <p>Telegram value:    0 = operation enabled                       1 = operation disabled</p>				
<b>20</b>	<b>Forced operation</b>	<b>Output A</b>	<b>2 bit DPT 2.002</b>	<b>C, W</b>
<p>This communication object is enabled when in <a href="#">Parameter window Safety</a>, page 36, the parameter <i>Forced operation</i> has been selected with the option <i>activated</i>.</p> <p>If a telegram with the value 2 (binary 10) is received on this communication object, then the shutter/blind is opened and operation is blocked.</p> <p>If a telegram with the value 3 (binary 11) is received on this communication object, then the shutter/blind is closed and operation is also blocked.</p> <p>If a telegram with the value 0 (binary 00) or 1 (binary 01) is received after a 2 or a 3, then the shutter/blind is moved to the <i>Position on reset of weather alarm, blocking and forced operation position</i> and re-enabled.</p> <p>Telegram value:    0           (binary 00):        Enable operation                       1           (binary 01):        Enable operation                       2           (binary 10):        UP/operation disabled                       3           (binary 11):        DOWN/operation disabled</p>				
<b>21</b>	<b>Telegr. status position 0...255</b>	<b>Output A</b>	<b>1 byte DPT 5.001</b>	<b>C, R, T</b>
<p>This communication object is enabled, if in <a href="#">Parameter window Status</a>, page 39, the parameter <i>Send position: 0...255</i> has been selected with the option <i>yes</i>.</p> <p>The actuator sends the current position of the shutter/blind to this communication object.</p> <p>Telegram value:    0 = upper                       ... = intermediate position                       255 = lower</p> <p>The current position is sent after completion of a movement. If a new movement has commenced in the meantime, the current position is sent only after completion of the last movement action.</p>				
<b>22</b>	<b>Telegr. status louvre 0...255 (Blinds mode)</b>	<b>Output A</b>	<b>1 byte DPT 5.001</b>	<b>C, R, T</b>
<p>This communication object is enabled, if in <a href="#">Parameter window Status</a>, page 39, the parameter <i>Send position: 0...255</i> has been selected with the option <i>yes</i>.</p> <p>The device sends the current position of the louvre setting to this communication object.</p> <p>Telegram value:    0 = louvre fully opened                       ... = intermediate position                       255 = louvre fully closed</p> <p>The current position is sent after completion of a movement. If a new movement has commenced in the meantime, the current position is sent only after completion of the last movement action.</p>				

# ABB i-bus<sup>®</sup> KNX Commissioning

No.	Function	Object name	Data type	Flags		
23	Telegr. status of upper pos.	Output A	1 bit DPT 1.008	C, R, T		
<p>This communication object is enabled, if in <a href="#">Parameter window Status</a>, page 39, the parameter <i>Send position: limit position reached</i> has been selected with the option <i>yes</i>.</p> <p>The device sends information to this communication object regarding if the shutter/blind is, or is not in the upper end limit position.</p> <p>Telegram value:     0 = shutter/blind not in upper end position                           1 = shutter/blind in upper end position</p> <p>The upper status position is sent, after the upper end position is achieved or exited.</p>						
24	Telegr. status of lower pos.	Output A	1 bit DPT 1.008	C, R, T		
<p>This communication object is enabled, if in <a href="#">Parameter window Status</a>, page 39, the parameter <i>Send position: limit position reached</i> has been selected with the option <i>yes</i>.</p> <p>The device sends information to this communication object regarding if the shutter/blind is, or is not in the lower end limit position.</p> <p>Telegram value:     0 = shutter/blind not in lower end position                           1 = shutter/blind in lower end position</p> <p>The lower status position is sent, after the lower end position is achieved or exited.</p>						
25	Telegr. status of operation	Output A	1 bit DPT 1.002	C, R, T		
<p>This communication object is enabled when in <a href="#">Parameter window Status</a>, page 39, the parameter <i>Send status of operation</i> has been selected with the option <i>yes</i>.</p> <p>On this communication object, the device sends information if the shutter/blind operation is enabled or disabled.</p> <p>This operation is disabled if either one of the safety functions has been activated (e.g. <i>Wind alarm</i>) or if the actuator has been toggled to manual operation.</p> <p>Telegram value:     0 = operation enabled                           1 = operation disabled</p> <p>The operation status is sent, when a change occurs.</p>						
26	Telegr. status automatic control	Output A	1 bit DPT 1.011	C, R, T		
<p>This communication object is enabled when in <a href="#">Parameter window Status</a>, page 39, the parameter <i>Send status of automatic control</i> has been selected with the option <i>yes</i>.</p> <p>On this communication object, the device sends information regarding if automatic control has been activated.</p> <p>Telegram value:     0 = automatic not activated                           1 = automatic activated</p> <p>The automatic status is sent when a change occurs.</p>						
<table border="1" style="width: 100%;"> <thead> <tr> <th style="text-align: left;">Note</th> </tr> </thead> <tbody> <tr> <td>If the device is toggled to manual operation when automatic is activated, a 0 is sent to this communication object. A 0 is also sent if a safety function has been activated (e.g. <i>Wind alarm</i>) when automatic is activated.</td> </tr> </tbody> </table>					Note	If the device is toggled to manual operation when automatic is activated, a 0 is sent to this communication object. A 0 is also sent if a safety function has been activated (e.g. <i>Wind alarm</i> ) when automatic is activated.
Note						
If the device is toggled to manual operation when automatic is activated, a 0 is sent to this communication object. A 0 is also sent if a safety function has been activated (e.g. <i>Wind alarm</i> ) when automatic is activated.						

No.	Function	Object name	Data type	Flags
27	<b>Telegr. status byte</b>	<b>Output A</b>	<b>1 byte DPT 6.020</b>	<b>C, R, T</b>
<p>This communication object is enabled when in <a href="#">Parameter window Status</a>, page 39, the parameter <i>Send status byte</i> has been selected with the option <i>yes</i>.</p> <p>Using this communication object, the device sends the information regarding the mode, in which the drive is currently operating. Only one mode can be activated at any time.</p> <p>Telegram code: 76543210</p> <p>Bit No.           7:       Heating / cooling automatic                            6:       Automatic sun protection                            5:       Wind alarm                            4:       Rain alarm                            3:       Frost alarm                            2:       Forced operation                            1:       Block                            0:       Manual operation</p> <p>Telegram value:  0:       Not activated                            1:       Activated</p> <p>The status byte is sent on changes.  <b>For further information see: <a href="#">Code table Status byte</a>, page 79</b></p>				
28	<b>Telegr. status SMI failure</b>	<b>Output A</b>	<b>1 bit DPT 1.011</b>	<b>C, R, T</b>
<p>This communication object is enabled when in <a href="#">Parameter window Status</a>, page 39, the parameter <i>Status SMI failure</i> has been selected with the option <i>yes</i>.</p> <p>Using this communication object, the device sends a telegram with the value 1, if no drive can be detected on the SMI output or the 230 V operating voltage has failed.</p> <p>Telegram value:  0 = SMI o.k.                            1 = SMI or 230 V has failed</p> <p>The SMI failure is sent on changes.</p>				
29	<b>Telegr. status number of drives</b>	<b>Output A</b>	<b>1 bit DPT 1.011</b>	<b>C, R, T</b>
<p>This communication object is enabled when in <a href="#">Parameter window Status</a>, page 39, the parameter <i>Send status number of SMI drives</i> has been selected with the option <i>yes</i>.</p> <p>Using this communication object, the device sends a telegram with the value 1, if the number of connected drives per SMI output deviates from the number of parameterized drives.</p> <p>Telegram value:  0 = number of drives o.k.                            1 = number of drives too high/ too low</p> <div style="border: 1px solid black; padding: 5px; margin-top: 10px;"> <p><b>Note</b></p> <p>If more than four drives are connected to a channel, the actuator will only carry out alarm and safety functions. No telegrams via the KNX are carried out. Operation of the manual buttons on the front of the device is still possible.</p> </div>				







# ABB i-bus<sup>®</sup> KNX Commissioning

No.	Function	Object name	Data type	Flags
<b>30</b>	<b>Telegr. diagnostic byte</b>	<b>Output A</b>	<b>1 byte DPT 6.020</b>	<b>C, R, T</b>
<p>This communication object is enabled when in <a href="#">Parameter window Status</a>, page 39, the parameter <i>Send SMI diagnostic byte</i> has been selected with the option <i>yes</i>.</p> <p>Using this communication object, the device sends information concerning the current state of the drive on the KNX.</p> <p>Telegram code: 76543210</p> <ul style="list-style-type: none"> <li>7: No communication</li> <li>6: Motor moves up</li> <li>5: Motor moves down</li> <li>4: Motor fault</li> <li>3: Short-circuit on SMI (hardware fault)</li> <li>2: More drives detected than configured</li> <li>1: Less drives detected than configured</li> <li>0: More than 4 drives detected on SMI</li> </ul> <p>Telegram value: 0: Not activated 1: Activated</p> <p>The diagnostics byte is sent with changes.</p> <p><b>For further information see: <a href="#">Code table Diagnostic byte</a>, page 80</b></p>				
<b>31...60</b>	<b>Analog output A</b>	<b>Output B</b>		
<b>61...90</b>	<b>Analog output A</b>	<b>Output C</b>		
<b>91... 120</b>	<b>Analog output A</b>	<b>Output D</b>		

## 3.3.3

### Communication objects *General*

No.	Function	Object name	Data type	Flags
121	<b>Telegr. auxiliary voltage status</b>	<b>Output A-D</b>	<b>1 bit DPT 1.005</b>	<b>C, R, T</b>
<p>This communication object is enabled when in <a href="#">Parameter window Manual</a>, page 24, the parameter <i>Send status auxiliary voltage/ SMI supply voltage</i> has been selected with the option <i>yes</i>.</p> <p>On this communication object, the device sends information regarding whether the 230 V auxiliary voltage has been connected.</p> <p>Telegram value:    0 = 230 V AC auxiliary voltage supply o.k.                           1 = 230 V AC auxiliary voltage supply not o.k.</p> <p>If the 230 V AC auxiliary voltage fails, the SMI drives cannot be controlled and read.</p> <p>The auxiliary voltage status is sent when a change occurs.</p>				
122	<b>Disable/ block manual operation</b>	<b>Output A-D</b>	<b>1 bit DPT 1.001</b>	<b>C, W</b>
<p>This communication object is enabled when in <a href="#">Parameter window Manual</a>, page 24, the parameter <i>Manual operation</i> has been selected with the option <i>via object enable/ disable</i>.</p> <p><i>Manual operation</i> of the device is blocked or enabled via this communication object.</p> <p>Using the value 0, the button  is enabled on the device. If the device is in <i>Manual operation</i>, it toggles immediately to <i>KNX operation</i>.</p> <p>Using the value 1, the button  is blocked on the device.</p> <p>Telegram value:    0 = button  enabled                           1 = button  disabled</p>				
123	<b>Telegr. status of man. operation</b>	<b>Output A-D</b>	<b>1 bit DPT 1.001</b>	<b>C, R, T</b>
<p>This communication object is enabled when in <a href="#">Parameter window Manual</a>, page 24, the parameter <i>Send status of manual operation</i> has been selected with the option <i>yes</i>.</p> <p>This communication object indicates whether manual operation is activated.</p> <p>Telegram value:    0 = manual operation not active                           1 = manual operation active</p> <p>The status of manual operation is sent <i>after a change</i>, <i>after request</i> or <i>after a change and request</i> as programmed.</p>				
124 125 126 127 128	<b>Wind alarm No. 1</b> <b>Wind alarm No. 2</b> <b>Wind alarm No. 3</b> <b>Rain alarm</b> <b>Frost alarm</b>	<b>Output A-D</b> <b>Output A-D</b> <b>Output A-D</b> <b>Output A-D</b> <b>Output A-D</b>	<b>1 bit DPT 1.005</b>	<b>C, R, T, U</b>
<p>These communication objects are enabled in <a href="#">Parameter window Weather</a>, page 29.</p> <p>These communication objects can be cyclically monitored. The interval is determined by the monitoring time. If a telegram with the value 0 is received within the monitoring time, the operation of the shutter/blinds are enabled.</p> <p>If a telegram with the value 1 is received or no telegram is received during the monitoring period, the shutter/blinds are moved to the parameterized <i>Position on wind alarm</i> (or with a <i>Rain alarm</i> or <i>Frost alarm</i>). Operation via direct telegrams and automatic telegrams is disabled.</p> <p>If after a weather alarm or after the monitoring period has been exceeded, a telegram with the value 0 is received for the first time, the shutter/blind is moved to the <i>Position on reset of weather alarm</i> and the operation is re-enabled.</p> <p>The monitoring period is restarted after each telegram is received as well as after programming of the actuator and with bus voltage recovery. The three wind alarm communication objects are logically connected via an OR gate, i.e. if a wind alarm is present for one of the three communication objects or a telegram is not received within the monitoring period, the shutter/blind moves to the parameterized <i>Position on wind alarm</i>.</p> <p>Telegram value:    0 = no alarm                           1 = alarm (condition disabled)</p>				

# ABB i-bus<sup>®</sup> KNX Commissioning

No.	Function	Object name	Data type	Flags
<b>129</b>	<b>Scene</b>	<b>Output A-D</b>	<b>8 bit DPT 18.001</b>	<b>C, W</b>
<p>This communication object is enabled when in <a href="#">Parameter window Output A-D Scene</a>, page 51, the parameter <i>1 byte scene</i> has been selected with the option <i>activated</i>.</p> <p>With this communication object, each output can be integrated in up to ten scenes. With this communication object, the number of the recalled scene is received as well as the information stating if the last saved value is to be used, or if the current position is to be saved as a new preset value, using just a single telegram.</p> <p>Telegram code:   MXNNNNNN</p> <p>Telegram value:   NNNNNN: 0...63: Scene number                          X:        free (contains no information)                          M:        0 = recall scene                                      1 = save scene</p> <p>The saved scene values are retained with the bus voltage failure, as is the case, if only the parameters are loaded when programming. If the programming of the complete application is reloaded, then the scene value is reset to the <i>fully upwards</i> position.</p> <p><b>For further information see: <a href="#">Code table Scene (8 bit), DPT 18.001</a>, page 81 with all possible combinations</b></p>				
<b>130</b>	<b>Time for automatic reactivation</b>	<b>Output A-D</b>	<b>2 byte DPT 7.006</b>	<b>C, W</b>
<p>This communication object is enabled when in <a href="#">Parameter window General</a>, page 21, the parameter <i>Allow parameter changes via EIB/KNX</i> has been selected with the option <i>yes</i>.</p> <p>With this communication object, the parameter <i>Time to reactivate automatic control automatically</i> can be changed via the KNX.</p> <p>Telegram value:   0           = automatic reactivation deactivated                          1...1,000 = time to reactivate automatic control automatically</p> <p>On a bus voltage failure, the changed parameter settings are retained.</p> <div style="border: 1px solid black; padding: 5px; margin: 10px 0;"> <p><b>Note</b></p> <p>Only telegram values between 0 and 1,000 minutes are valid. If another value is sent, the telegram does not initiate a parameter change.</p> </div> <p><b>For further information see: Parameter <a href="#">Time to reactivate automatic control automatically</a>, page 46</b></p>				
<b>131</b>	<b>Delay time on sun = 1</b>	<b>Output A-D</b>	<b>2 byte DPT 7.005</b>	<b>C, W</b>
<b>132</b>	<b>Delay time on sun = 0</b>	<b>Output A-D</b>		
<b>133</b>	<b>Delay for presence = 1</b>	<b>Output A-D</b>		
<b>134</b>	<b>Delay for presence = 0</b>	<b>Output A-D</b>		
<p>This communication object is enabled when in <a href="#">Parameter window General</a>, page 21, the parameter <i>Allow parameter changes via EIB/KNX</i> has been selected with the option <i>yes</i>.</p> <p>With this communication object, the parameters of the same name can be modified via KNX.</p> <p>Telegram value:   0...6,000 (in seconds)</p> <p>On a bus voltage failure the changed parameter settings are retained.</p> <div style="border: 1px solid black; padding: 5px; margin: 10px 0;"> <p><b>Note</b></p> <p>Only telegram values between 0 and 6,000 seconds are valid. If another value is sent, the telegram does not initiate a parameter change.</p> </div> <p><b>For further information see from parameter <a href="#">Delay for sun = 1</a>, page 48</b></p>				



## 4 Planning and Application

### 4.1 Standard Motor Interface (SMI)

#### 4.1.1 Introduction

SMI is a digital interface for control of electrical blinds and shutter drives. Telegrams between the control and drive are exchanged via SMI. The control sends travel telegrams to the drive; the drive sends status messages to the control.

SMI certified products from different manufacturers are compatible and can be operated simultaneously in a system.

The Blind/Shutter Actuators JA/S 4.SMI.1M and SJR/S 4.24.2.1 from ABB STOTZ-KONTAKT converts KNX telegrams to SMI telegrams and enables the control of SMI drives via KNX. Furthermore, they receive status messages from SMI drives and can, for example, pass on this information via KNX to a visualisation system.

Blind control with SMI has three advantages compared to the traditional blind control using relay technology:

- The shutter/blind can be positioned more precisely:
  - The determination of the current position as well as the movement to a target position occurs directly on a SMI drive. Accordingly, inaccuracies associated with calculation of the position via travel times are not an issue.
- Status messages from the drive can be evaluated via KNX
  - The SMI drive not only determines the precise position, but also other diagnostic and error messages, e.g.:
    - Motor fault
    - Motor moves DOWN
    - Motor moves UP
    - Communication diagnostics
- Reduction of the wiring work
  - SMI drives can be wired in parallel.

#### 4.1.2 Connection

The SMI drive is connected using a 5-core cable with a maximum length of 350 meters. Three cores are used for the phase, neutral and PE, and two cores are used for data transmission.

Up to 16 SMI drives can be connected to an SMI cable (max. 4 SMI drives per output with JA/S 4.SMI.1M and SJR/S 4.24.2.1). Three different operating modes are used to control the drives:

- Single operation
- Parallel operation with multiple addressing
- Parallel operation with single addressing\*

\* does not apply for JA/S 4.SMI.1M and SJR/S 4.24.2.1

# ABB i-bus<sup>®</sup> KNX

## Planning and Application

Blind/Shutter Actuators JA/S 4.SMI.1M and SJR/S 4.24.2.1 from ABB STOTZ-KONTAKT support both of the first two operating modes. In contrast to the third operating mode, no SMI commissioning knowledge is necessary.

### Single operation

Only one SMI drive is connected to each output of the actuator. The full range of functionality is available, particularly the exact positioning of the shutter/blind and the use of status messages from the drive.

### Parallel operation with multiple addressing

Up to 4 SMI drives can be connected to an output of the actuator. All connected drives can only be controlled as a group. This operating mode is particularly suitable, for example, for offices with 2 or more windows, in which the blinds are operated in parallel. In parallel operation with multiple addressing, exact positioning is available just as with single operation. The status messages of the drive cannot, however, be uniquely evaluated, as it is not possible to determine from which drive the message originates. Status messages can therefore only be used on a limited basis.

### 4.1.3 Commissioning

No SMI knowledge is required for KNX commissioning. The SMI Actuators JA/S 4.SMI.1M and SJR/S 4.24.2.1 are connected to the KNX as well as to the SMI data cable and commissioned via the ETS.

All settings in the ETS can be undertaken with the existing product manual.

### 4.1.4 SMI technical data

#### SMI interface

Concept	One master (actuator), multiple slaves (drives)
Drive connection	5-core installation cable without shielding
Number of SMI drives	1 to max. 16 per SMI output (max. 4 SMI drives per SMI output with JA/S 4.SMI.1M and SJR/S 4.24.2.1)
Max. cable length	350 m
Topology	any
Baud rate	2,400 bits/s
Data transmission	bi-directional

#### Operating modes

- Single operation
- Parallel operation with multiple addressing
- Parallel operation with single addressing\*

\* does not apply for JA/S 4.SMI.1M and SJR/S 4.24.2.1

More detailed information concerning SMI technology as well as a planning manual can be found at [www.smi-group.com](http://www.smi-group.com)

## 4.2 Move to position

### Move to position 0...100 %

The shutter/blind can be moved into any position via an 8 bit value. In the *Blinds* operation mode, the louvres can also be positioned into any angle via an 8 bit value. In this way, it can be decided for each movement telegram on the position that the shutter/blind should move to. It is possible to set the position from a display or a visualisation terminal.

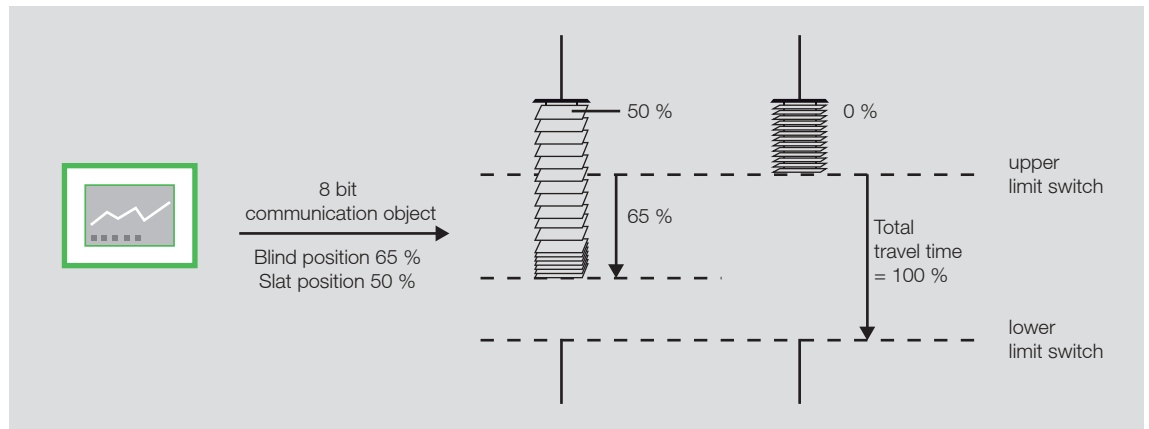

### Move to preset position

For each output, it is possible to parameterize up to 4 preset positions individually, which are then recalled via a 1 bit telegram. When moving into one of these preset positions, the target position must first be set, either via the parameters during programming or via the function *Set preset position*. This preset target position can then, for example, be recalled as often as required by pressing a push button.

## Set preset position

The preset position can be changed very easily via a 1 bit telegram. To do so, the blinds are moved via UP/DOWN telegrams as well as STOP/louvre adjustment UP/DOWN telegrams into the required new preset position. The new position is adopted via a 1 bit telegram as a new preset position into the memory of the device.

### Example

The blinds are moved into a preset position after a short push button action, and the current position is adopted as the new preset position after a long push button action.

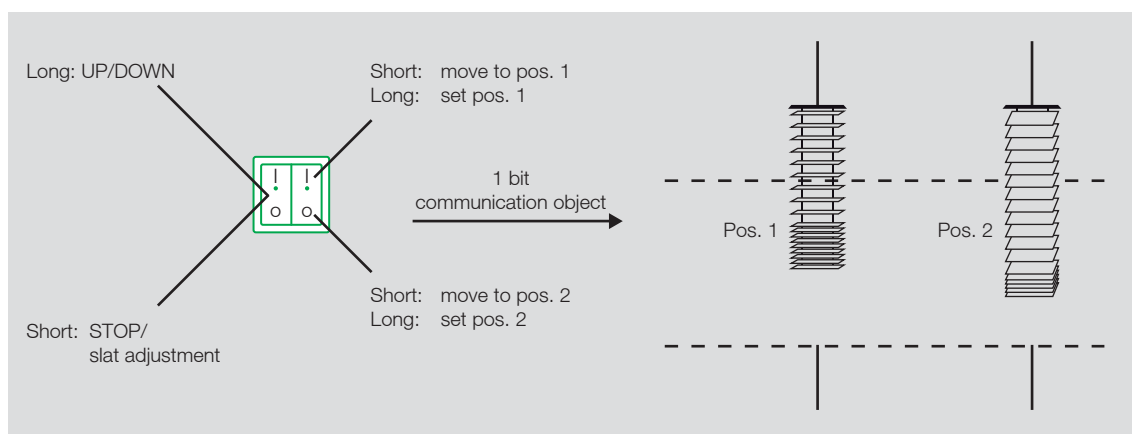

The saved preset values are retained with a bus voltage failure. With the programming, it is possible to set via a parameter if the saved values should be overwritten by the parameterized values.



## 4.3 Automatic controls

### 4.3.1 Automatic sun protection

#### Function

Together with other KNX components, a very comfortable sun automatic control can be established with the blind/shutter actuators. The automatic sun protection controls the shutter/blind according to the level of sunlight. Depending on the strength and direction of the sun, the shutter/blind is moved into a parameterized position via an 8 bit value or into a variable position, depending on the situation.

For example, the blinds can be moved UP if the sunshine is very weak or if the window concerned is in the shade. As much light as possible is thereby let into the room without any disruptive direct sunlight being taken into account. If there is blazing sunshine on the window however, the blind is lowered and the louvres are closed to the extent that direct sunlight cannot penetrate the room. The residual opening in the blinds lets in a sufficient level of diffuse light into the room.

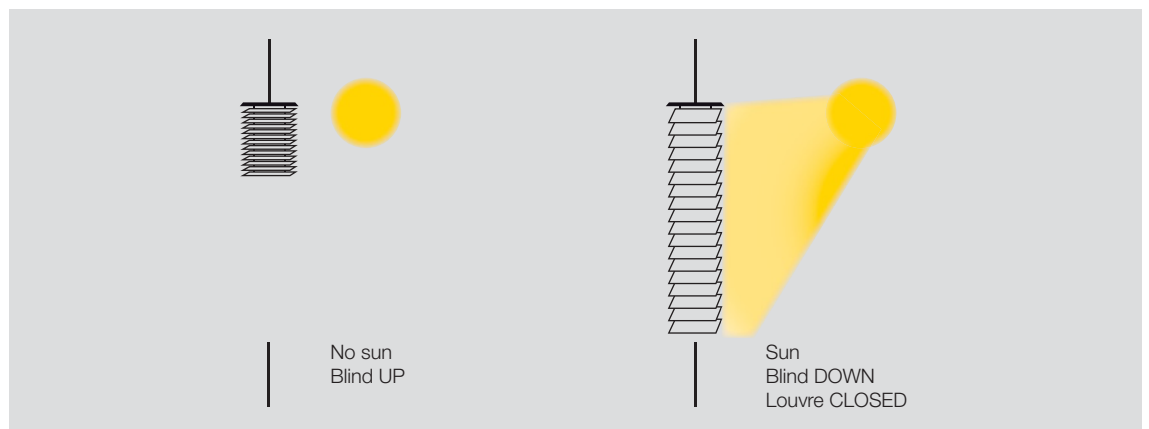

When using special directional louvres, the direct light into the room is guided, so that the no disruptive direct light penetrates the room but at the same time optimum use is made of the existing natural daylight.



## Setting up a simple automatic sun protection system

Two further components are required in addition to the actuator and touch sensor in order to set up a simple automatic sun protection system: an activation option for the user, e.g. a further switch sensor or the second rocker of the UP/DOWN touch sensor and a brightness sensor. With the help of the second switch sensor, the user of the room can specify whether they wish to use the automatic sun protection or whether they would rather control the shutters/blinds manually. If the automatic sun protection is activated via a switch sensor, the shutter/blind moves automatically until either the automatic sun protection is deactivated via the same switch sensor or the user issues a direct travel telegram, e.g. UP/DOWN or move into position, and the automatic function is thus also deactivated. This also deactivates the automatic control.

The actuator receives the information via the brightness sensor as to whether there is direct sunlight on the window or the façade. Once the parameterizable delay period has elapsed, the actuator positions the shutter/blind according to the set *Position for sun = 1 (sun)* or *Position for sun = 0 (no sun)*.

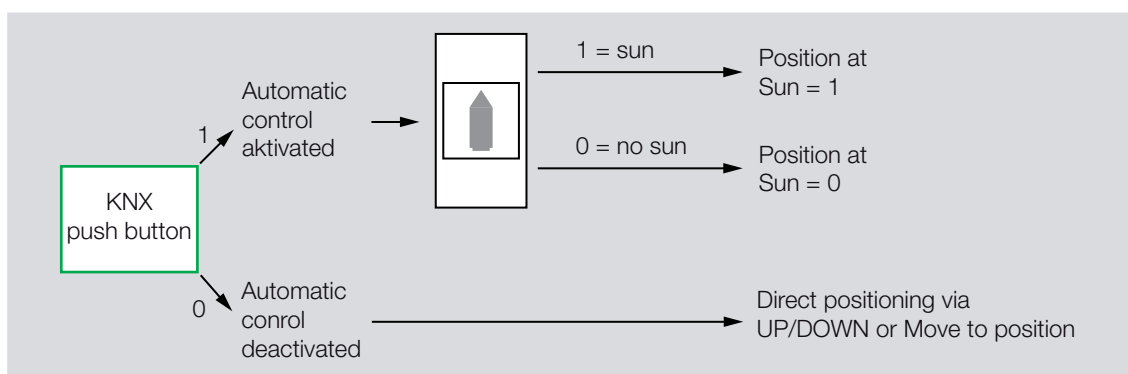

# ABB i-bus<sup>®</sup> KNX Planning and Application

## Planning a simple automatic sun protection system

To set up an automatic sun protection system with tracking of the sun's position, the following KNX components are required:

- Blind/shutter actuator
- KNX switch sensor or universal interface with push button
- Brightness sensor

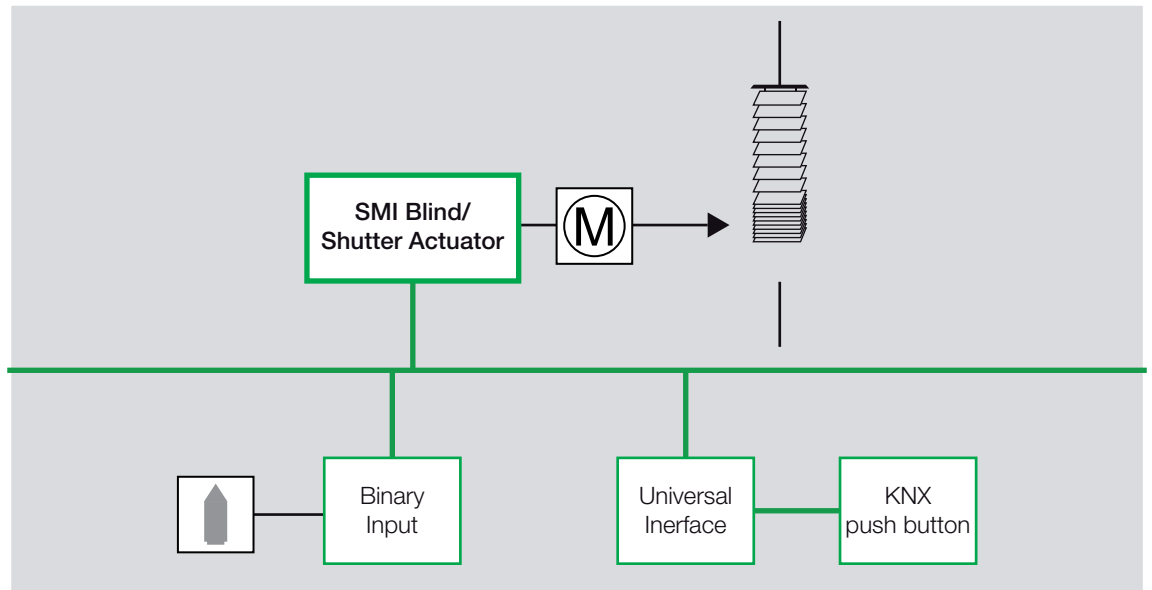

## Design of an automatic sun protection system with tracking of the sun's position

To set up an automatic sun protection system with tracking of the sun's position, an additional control unit is required, e.g. the Shutter Control Unit JSB/S.

The current position of the sun is continually calculated in the shutter control unit. The shutter/blind is moved via an 8 bit value into the optimum position to deflect direct sunshine, but to let through as much diffuse light as possible. The influence of shadows, e.g. the buildings opposite, can also be taken into account in the shutter control unit.

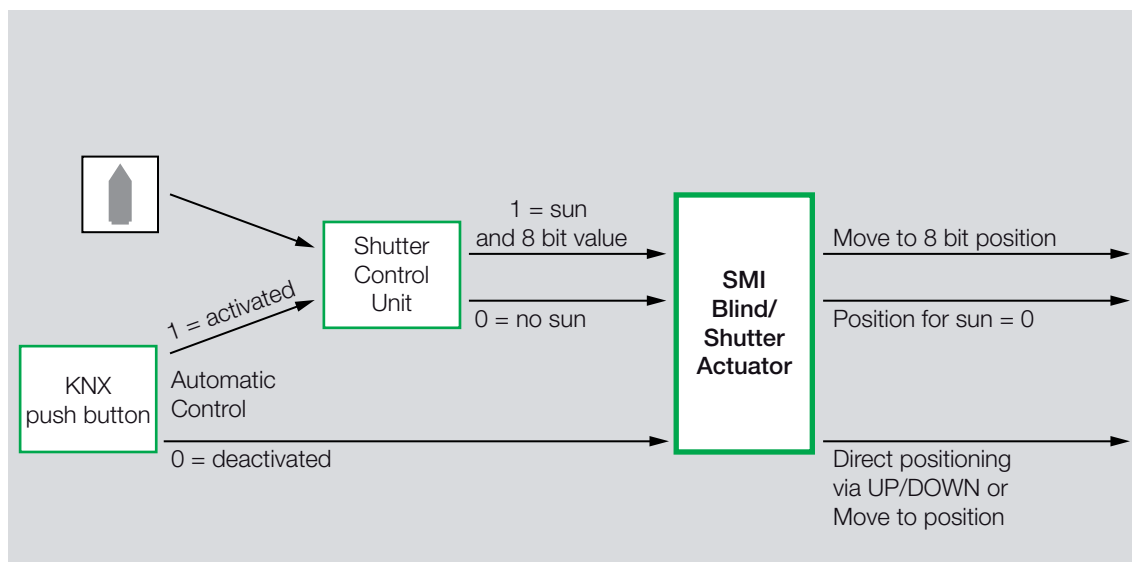

## Planning a simple automatic sun protection system with tracking of the sun's position

The following KNX components are required for setting up an automatic sun protection system including automatic sun protection with tracking of the sun's position:

- Blind/shutter actuator
- KNX switch sensor or universal interface with push button
- Brightness sensor
- Shutter control unit

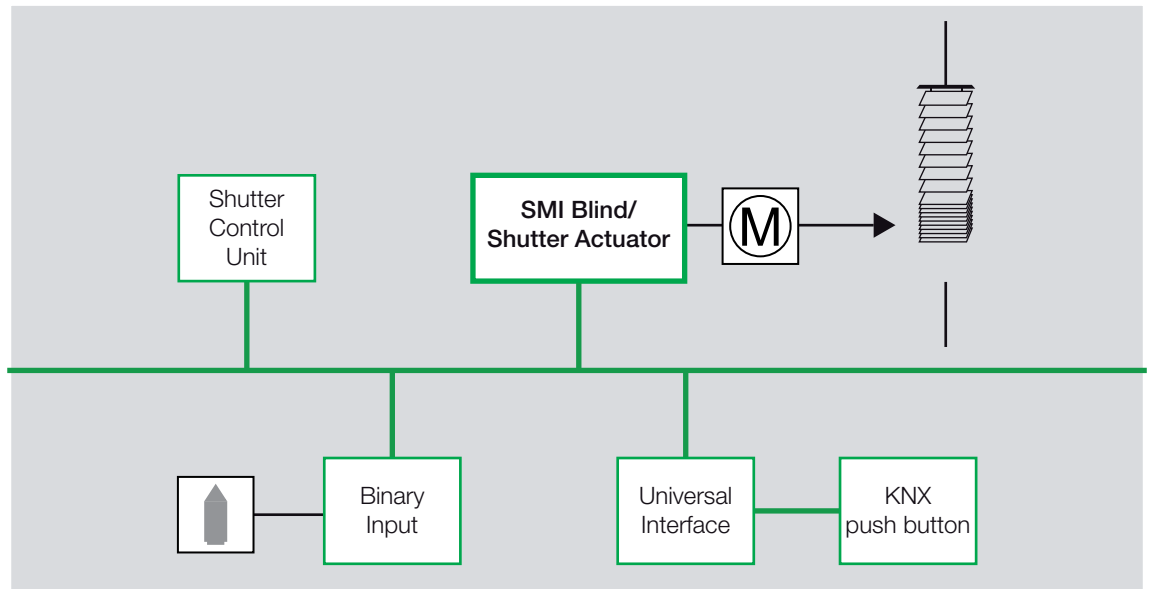

The current position of the sun is calculated based on the time of day. The Shutter Control Unit can be operated as an independent clock, as a master clock or as a slave clock on the KNX. Several shutter control units can also be synchronised together. If the shutter control unit is operated as an independent clock or as a master clock, no further time switches are required for sunblind/shutter control.

The shutter control unit can likewise be operated as a slave clock if, for example, a master clock is present in the installation. A time switch, which can send the time and date on the KNX, must be used as a master clock, if an additional time switch is added to the system.

## 4.3.2 Heating/cooling automatic

### Function

The heating/cooling automatic control moves the shutter/blinds according to the sun's rays and the required energy input requirement into the room. The shutter/blind is moved into a set position depending on whether the room should be heated or cooled and how strong the sun is and in which direction it is shining. The shutter can, for example, be raised during the heating phase when the sun is shining to achieve a maximum energy input into the room. If there is no sun, for example during the night, an internal blind is closed, which ensures that the heat collected during the day is not completely lost during night reduction. During the cooling phase, the blind can be lowered during full sunshine in order to keep the energy input at a minimum. During the night, a reduction in the room temperature in an air-conditioned room to the external temperature can likewise be counteracted by the use of an internal blind.

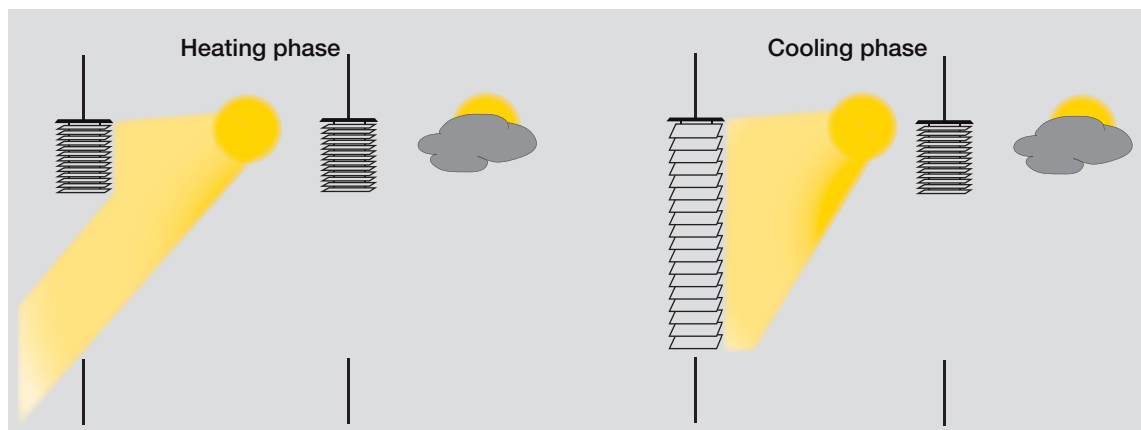

# ABB i-bus<sup>®</sup> KNX Planning and Application

## Setup

Two further components are required in addition to the automatic control components in order to set up an automatic heating/cooling control system:

- a toggle option between automatic sun protection and heating/cooling automatic, e.g. a presence detector.
- a toggle option between HEATING and COOLING, e.g. a yearly clock timer or a temperature sensor.

With the help of the switch sensor, the user of the room can specify whether they wish to use the automatic control or whether they would rather control the shutters/blinds manually. If the automatic control is activated, the shutter/blind moves automatically until either the automatic is deactivated via the same switch sensor or the user issues a direct travel telegram, e.g. UP/DOWN or move into position. This also deactivates the automatic control.

The actuator receives the information via the presence detector as to whether there are people in the room. If the room is occupied, the blind is controlled according to the automatic sun protection function. If nobody is in the room, the shutter/blind is controlled according to the heating/cooling automatic.

The actuator receives, for example, the information via a year timer switch or a thermostat as to whether the room should be heated or cooled. The shutter/blind moves into the set heating or cooling position, depending on the position and intensity of the sun.

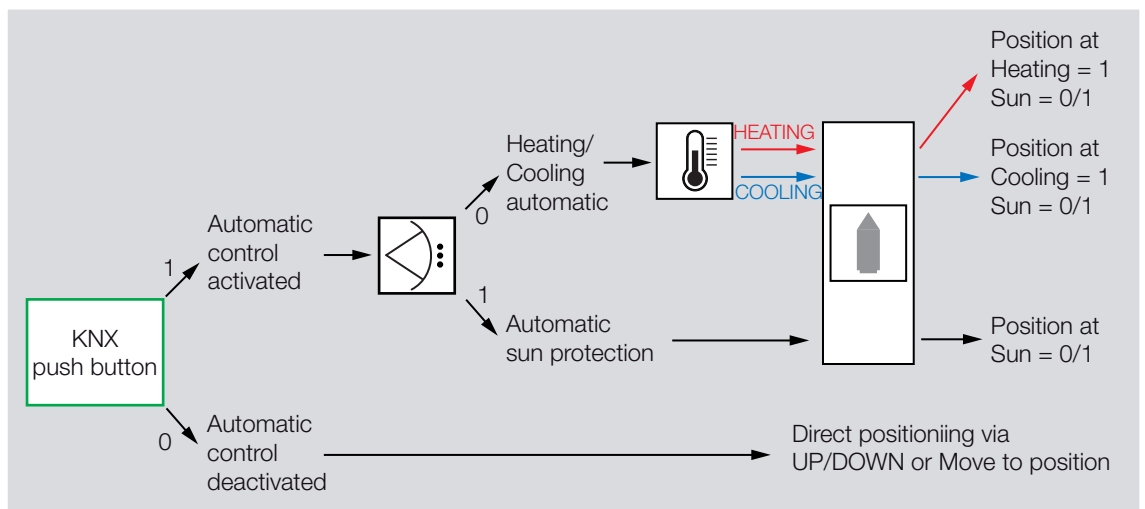

## Planning information

The following KNX components are required for setting up an automatic heating/control system including automatic sun protection with tracking of the sun's position.

- Blind/shutter actuator
- KNX switch sensors or Universal Interface with push button
- KNX Presence Detector or universal interface with presence detector
- Brightness sensor
- Shutter control unit
- External thermostat

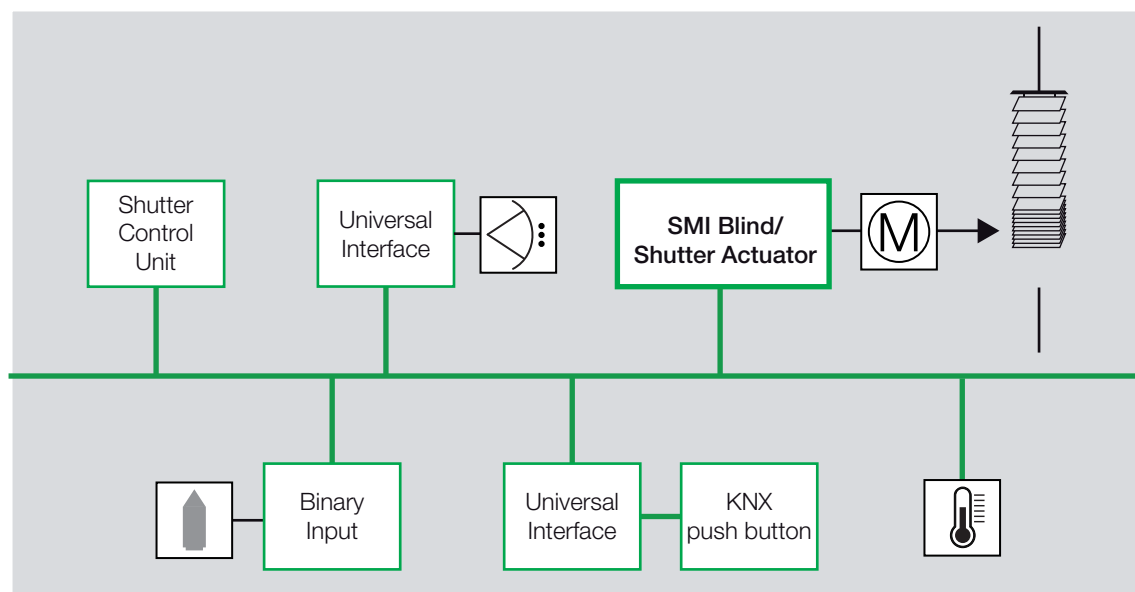

The automatic heating/cooling control for shutters/blinds is predominantly carried out independently of the individual room temperature control. Optimum use is made of the sun as an energy source for controlling the blinds, thereby saving energy. The remaining temperature differential to the setpoint temperature is balanced out via the individual room temperature control.

As a result, if a room should be protected all day against the sunlight, for example, the air conditioning system only occasionally cools down the room via a 2-step controller. In this case, the control of the air conditioning system is independent of the control of the shutter/blind.

The same room thermostat should therefore not be used for controlling the shutters/blinds, but rather an external thermostat or a year timer switch, e.g. heating period from November to March, cooling period from June to August. A time switch with 1 bit telegrams is sufficient for heating/cooling automatic. If the time switch should also be used simultaneously as a master clock for automatic sun protection with tracking of the sun's position, it must also be able to send the time and the date on the KNX.



## A Appendix

### A.1 Code table *Status byte*

Bit No.		7	6	5	4	3	2	1	0		
Status byte value (decimal)	Hexadecimal	Heating/Cooling automatic	Automatic sun protection	Wind alarm	Rain alarm	Frost alarm	Forced operation	Block	Manual operation	Current status	Operation
0	00									Direct positioning	Via the communication objects: UP/DOWN STOP/louvre adjustment Move to position Scene
1	01								■	Manual operation	Via device buttons
2	02							■		Block	Disabled
4	04						■			Forced operation	Disabled
8	08					■				Frost alarm	Disabled
16	10				■					Rain alarm	Disabled
32	20			■						Wind alarm	Disabled
64	40		■							Automatic sun protection	Via the communication objects: Sun Sun position Sun louvre
128	80	■								Heating/Cooling automatic	Via the communication objects: Heating Cooling
Other	Other	X	X	X	X	X	X	X	X	Not defined	

empty = value 0

■ = value 1, applies



### A.3 Code table Scene (8 bit), DPT 18.001

The following table indicates the telegram code for an 8 bit scene in hexadecimal and binary code with the first 64 scenes. Normally when retrieving or storing a scene, an 8 bit value must be sent.

Bit No.	7	6	5	4	3	2	1	0		
0	00	0							1	A
1	01	0							2	A
2	02	0							3	A
3	03	0							4	A
4	04	0							5	A
5	05	0							6	A
6	06	0							7	A
7	07	0							8	A
8	08	0							9	A
9	09	0							10	A
10	0A	0							11	A
11	0B	0							12	A
12	0C	0							13	A
13	0D	0							14	A
14	0E	0							15	A
15	0F	0							16	A
16	10	0							17	A
17	11	0							18	A
18	12	0							19	A
19	13	0							20	A
20	14	0							21	A
21	15	0							22	A
22	16	0							23	A
23	17	0							24	A
24	18	0							25	A
25	19	0							26	A
26	1A	0							27	A
27	1B	0							28	A
28	1C	0							29	A
29	1D	0							30	A
30	1E	0							31	A
31	1F	0							32	A
32	20	0							33	A
33	21	0							34	A
34	22	0							35	A
35	23	0							36	A
36	24	0							37	A
37	25	0							38	A
38	26	0							39	A
39	27	0							40	A
40	28	0							41	A
41	29	0							42	A
42	2A	0							43	A
43	2B	0							44	A
44	2C	0							45	A
45	2D	0							46	A
46	2E	0							47	A
47	2F	0							48	A
48	30	0							49	A
49	31	0							50	A
50	32	0							51	A
51	33	0							52	A
52	34	0							53	A
53	35	0							54	A
54	36	0							55	A
55	37	0							56	A
56	38	0							57	A
57	39	0							58	A
58	3A	0							59	A
59	3B	0							60	A
60	3C	0							61	A
61	3D	0							62	A
62	3E	0							63	A
63	3F	0							64	A

Bit No.	7	6	5	4	3	2	1	0		
128	80	1							1	S
129	81	1							2	S
130	82	1							3	S
131	83	1							4	S
132	84	1							5	S
133	85	1							6	S
134	86	1							7	S
135	87	1							8	S
136	88	1							9	S
137	89	1							10	S
138	8A	1							11	S
139	8B	1							12	S
140	8C	1							13	S
141	8D	1							14	S
142	8E	1							15	S
143	8F	1							16	S
144	90	1							17	S
145	91	1							18	S
146	92	1							19	S
147	93	1							20	S
148	94	1							21	S
149	95	1							22	S
150	96	1							23	S
151	97	1							24	S
152	98	1							25	S
153	99	1							26	S
154	9A	1							27	S
155	9B	1							28	S
156	9C	1							29	S
157	9D	1							30	S
158	9E	1							31	S
159	9F	1							32	S
160	A0	1							33	S
161	A1	1							34	S
162	A2	1							35	S
163	A3	1							36	S
164	A4	1							37	S
165	A5	1							38	S
166	A6	1							39	S
167	A7	1							40	S
168	A8	1							41	S
169	A9	1							42	S
170	AA	1							43	S
171	AB	1							44	S
172	AC	1							45	S
173	AD	1							46	S
174	AE	1							47	S
175	AF	1							48	S
176	B0	1							49	S
177	B1	1							50	S
178	B2	1							51	S
179	B3	1							52	S
180	B4	1							53	S
181	B5	1							54	S
182	B6	1							55	S
183	B7	1							56	S
184	B8	1							57	S
185	B9	1							58	S
186	BA	1							59	S
187	BB	1							60	S
188	BC	1							61	S
189	BD	1							62	S
190	BE	1							63	S
191	BF	1							64	S

empty = value 0  
■ = value 1, applies

#### A.4 Ordering Information

Short description	Description	Order code	bbn 40 16779 EAN	Price group	Weight 1 pcs [kg]	Pack unit [Pcs]
<b>J/S 4.SMI.1M</b>	Blind/Shutter Actuator, 4-fold, SMI, MDRC	2CDG 110 028 R0011	<b>65423 4</b>	P2	0.25	1
<b>SJR/S 4.24.2.1</b>	Blind/Shutter Actuator, 4-fold, SMI LoVo, MDRC	2CDG 110 143 R0011	<b>86446 6</b>	P2	0.25	1

**A.5**            **Notes**

**Notes**



# Contact

## **ABB STOTZ-KONTAKT GmbH**

Eppelheimer Straße 82  
69123 Heidelberg, Germany  
Telefon: +49 (0)6221 701 607  
Telefax: +49 (0)6221 701 724  
E-Mail: [knx.marketing@de.abb.com](mailto:knx.marketing@de.abb.com)

**Further information and local contacts:**  
[www.abb.com/knx](http://www.abb.com/knx)

### **Note:**

We reserve the right to make technical changes or modify the contents of this document without prior notice. With regard to purchase orders, the agreed particulars shall prevail.

ABB AG does not accept any responsibility whatever for potential errors or possible lack of information in this document.

We reserve all rights to this document and in the subject matter and illustrations contained therein. Any reproduction, disclosure to third parties or utilization of its content – in whole or in parts – is forbidden without prior written consent of ABB AG.

Copyright© 2011 ABB  
All rights reserved

Publication number 2CDC 506 036 D0202 (11.11)