

# Stage 2 Architectural Loudspeakers

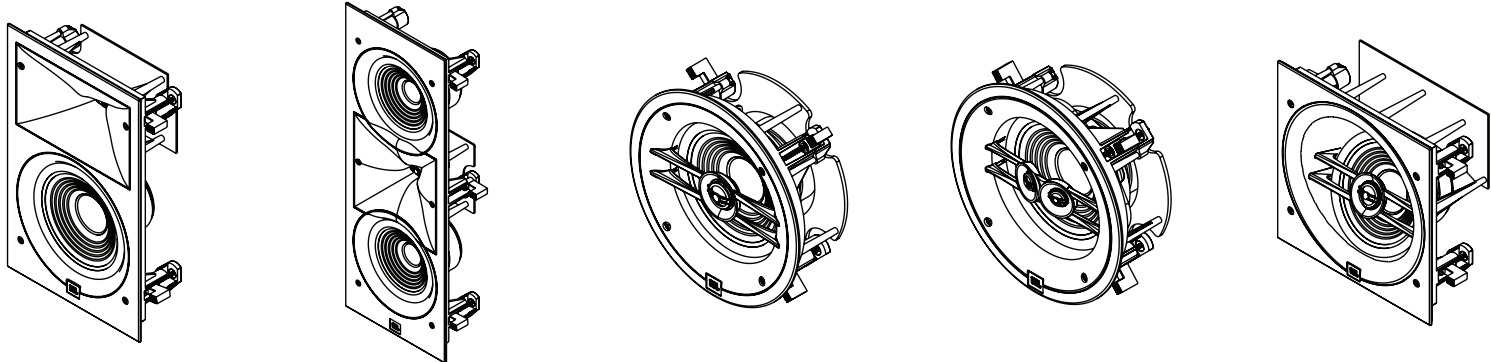

## Installation Guide

1.1 | 20220829

©2022 Harman International

# Overview

## Supported Products

The following products are supported within this document.

In-Wall Models	
Stage 250WL	2-way Dual 5.25" In-Wall
Stage 260W	2-way 6.25" In-Wall
Stage 280W	2-way 8" In-Wall
In-Ceiling Models	
Stage 260C	2-way 6.25" In-Ceiling
Stage 260CDT	2-way 6.25" Dual Tweeter In-Ceiling
Stage 260CSA	2-way 6.25" Angled In-Ceiling
Stage 280C	2-way 8" In-Ceiling
Stage 280CSA	2-way 8" Angled In-Ceiling

## Associated Accessories

There are several accessories available for new construction installations as well as square grille kits to change the appearance of the in-ceiling speakers.

Preconstruction Brackets	
WB81	Pre-Construction Bracket for 8" In-Wall
WB61	Pre-Construction Bracket for 6" In-Wall
CB6SA	Pre-Construction Bracket for 6" Angled In-Ceiling
CB8SA	Pre-Construction Bracket for 8" Angled In-Ceiling
Square Grille Kits	
SGK6	Square Grille Kit for 6" In-Ceiling
SGK8	Square Grille Kit for 8" In-Ceiling

## Box Contents

- 1x Stage Architectural Loudspeaker
- 1x Zero Bezel Grille
- 1x Cutout Template
- 1x Quick Start Guide (This Document)

## Safety Warnings

**⚠ IMPORTANT!** HARMAN International assumes no responsibility for improper installation of hardware or for any personal injuries or product damages resulting from improper installation or a fallen loudspeaker.

Read through this document in its entirety and heed all warning before proceeding with the installation of these product(s).

## **⚠ IMPORTANT!** Installation Precautions

Due to the nature of this product, there are several precautions to follow before installation can begin.

1. Allow sufficient clearance between the speaker and any insulation that may be in the wall cavity to avoid ignition should overheating occur.  
1" (26mm) for Non-Flammable Materials  
3" (78mm) for Flammable Materials
2. Ensure that all wire run inside of walls and ceiling meets or exceeds local fire codes for hidden wiring.
3. Determine wire lengths and select the proper gauge speaker wire to use based on the table under [Wire Gauge by Distance](#).
4. Do **NOT** overtighten the dog legs when securing the speaker to surfaces as this may cause the speaker to come loose. If using a power screwdriver set it to the lowest settings.
5. Do **NOT** connect the speakers to an amplifier rated above the recommended amplifier power. Overdriving the speaker can cause an overheating condition increasing the risk of injury.
6. Do **NOT** connect the amplifier end of the wire until all speakers are wired and installed.
7. Determine and purchase any accessories such as pre-construction brackets before beginning the installation process. Refer to [Associated Accessories](#) for a list of available brackets.
8. Ensure that wall and ceiling board material is between ½" (13mm) and 2" (51mm) thick and capable of supporting the weight of the speaker.

# Installation

Before proceeding with the installation be sure and read through these instructions carefully and in full to ensure that the installation will be complete and accurate. Should at any time these instructions seem unclear, contact your dealer or customer support for assistance.

## Preinstallation Preparations

While these architectural speakers have been designed to perform in a variety of environments, there are some guidelines to follow to ensure that you will be getting the best out of the speakers.

1. Read through the [IMPORTANT! Installation Precautions](#) before proceeding to ensure that all safety precautions have been met.
2. Determine a location for the speakers within the room and position on the wall and/or ceiling. Note that positioning them near boundaries such as other walls, ceilings, or floors with increase reflection that may have an adverse affect on the sound.
3. Determine wire lengths and select the proper gauge speaker wire to use based on the table under [Wire Gauge by Distance](#).
4. Run all wires from the amplifier location to the speaker location so that they are available when the speaker is installed. Ensure that wires are not connected at the amplifier at this time.

## Wire Gauge by Distance

Distance/Length	Wire Gauge
< 50ft (15m)	16-gauge
50ft (15m) ~ 100ft (30m)	12-gauge
> 100ft (30m)	10-gauge

5. For new construction ensure that all brackets are on hand and installed in the walls before installing the speakers. Install Pre-Construction brackets per instructions included with the brackets.
6. For existing walls and ceilings position the included cutout template onto the wall or ceiling and trace an outline onto the wall. Ensure that the template is equal distance from studs to allow for the XL-2 legs to fully extend. Use a stud finder if needed.

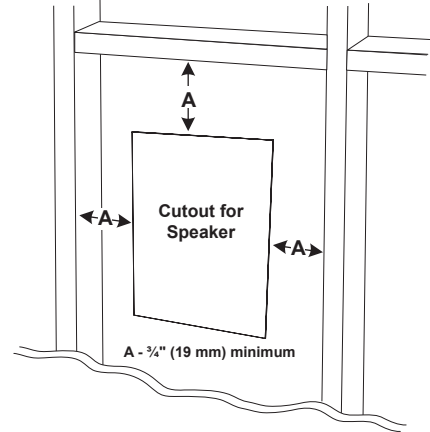

7. Using a Drywall saw, cutout a section of the wall/ceiling in the confines of the trace for the cutout.

## Installing the Speakers

1. Follow the steps under [Preinstallation Preparations](#) that apply to the installation.
2. Set the XL-2 legs on the speaker to the installation position. Must be inside the frame of the speaker in order to install speaker into cutout.

XL-2 Leg inside frame of speaker

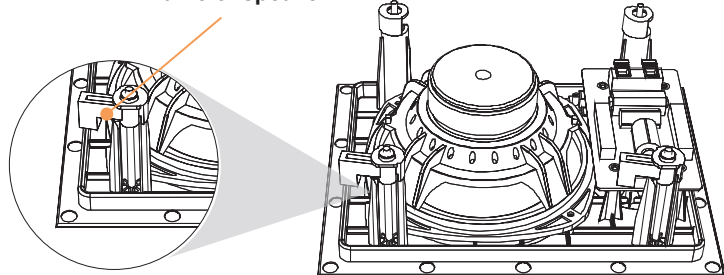



3. Attach the included safety wire to a stud inside the wall/ceiling near the side of the speaker with the safety ring eyelet.
4. Pull wire through pre-construction bracket or hole in wall/ceiling.
5. Strip  $\frac{1}{4}$ " (6.5mm) of insulation off each wire.
6. Starting with the negative terminal (black), gently press down on each terminal, insert the wire, and release. Repeat for the positive (red) terminal.
7. Install the speaker into the cutout/bracket, hold firmly to wall, and tighten the screws for the XL-2 legs.

**CAUTION!** Do **NOT** over tighten the screws as this can strip the legs and cause the speaker to come loose from the wall/ceiling.

8. Install the grille onto the speaker by gently placing it over the speaker until the magnets click and pull the grille onto speaker.

# Specifications



## In-Walls

	Stage 250WL	Stage 260W	Stage 280W
			
<b>High Frequency Transducer</b>	1" (25mm) Aluminum dome with High-Definition Imaging (HDI™) horn	1" (25mm) Aluminum dome with High-Definition Imaging (HDI™) horn	1" (25mm) Aluminum dome with High-Definition Imaging (HDI™) horn
<b>Low Frequency Transducer</b>	Dual 5.25" (130mm) Polycellulose cone woofer	6.5" (165mm) Polycellulose cone woofer	8" (200mm) Polycellulose cone woofer
<b>Recommended Amplifier Power</b>	20-120W RMS	20-100W RMS	20-120W RMS
<b>Frequency Response</b>	52Hz-25kHz (-6dB on-axis)	50Hz-25kHz (-6dB on-axis)	42Hz-25kHz (-6dB on-axis)
<b>Sensitivity (2.83V@1m)</b>	90dB	87dB	90dB
<b>Nominal Impedance</b>	8ohm	8ohm	8ohm
<b>Crossover Frequency</b>	2100Hz	1900Hz	1700Hz
<b>Inputs</b>	Nickel-plated spring-loaded connectors	Nickel-plated spring-loaded connectors	Nickel-plated spring-loaded connectors
<b>Grille Dimensions</b>	H: 19.5in (496mm) x W 7.6in (194mm)	H: 13.3in (339mm) x W 8.5in (217mm)	H: 15.7in (400mm) x W 10.5in (266mm)
<b>Cutout Dimensions</b>	H: 18.1in (460mm) x W: 6.4in (162mm)	H: 12.2in (311mm) x W: 7.2in (184mm)	H: 14.6in (372mm) x W: 9.4in (238mm)
<b>Mounting Depth</b>	3.8in (96mm)	3.6in (92mm)	3.9in (98mm)

## In-Ceiling (Standard)

	Stage 260C	Stage 280C
		
<b>High Frequency Transducer</b>	1" (25mm) Aluminum dome with Acoustic Lens	1" (25mm) Aluminum dome with Acoustic Lens
<b>Low Frequency Transducer</b>	6.5" (165mm) Polycellulose cone woofer	8" (200mm) Polycellulose cone woofer
<b>Recommended Amplifier Power</b>	20-100W RMS	20-120W RMS
<b>Frequency Response</b>	50Hz-25kHz (-6dB on-axis)	42Hz-25kHz (-6dB on-axis)
<b>Sensitivity (2.83V@1m)</b>	87dB	90dB
<b>Nominal Impedance</b>	8ohm	8ohm
<b>Crossover Frequency</b>	3000Hz	3400Hz
<b>Inputs</b>	Nickel-plated spring-loaded connectors	Nickel-plated spring-loaded connectors
<b>Grille Dimensions</b>	Dia: 9.2in (233mm)	Dia: 10.8in (275mm)
<b>Cutout Dimensions</b>	Dia: 8in (203mm)	Dia: 9.6in (244mm)
<b>Mounting Depth</b>	3.9in (100mm)	4.3in (108mm)

## In-Ceiling (Special Use)

	Stage 260CDT	Stage 280CSA	Stage 250CSA
			
<b>High Frequency Transducer</b>	Dual 3/4" (20mm) Aluminum dome with Acoustic Lens	1" (25mm) Aluminum dome with Acoustic Lens	1" (25mm) Aluminum dome with Acoustic Lens
<b>Low Frequency Transducer</b>	Dual VC 6.5" (165mm) Polycellulose cone woofer	6.5" (165mm) Polycellulose cone woofer	8" (200mm) Polycellulose cone woofer
<b>Recommended Amplifier Power</b>	20-75W RMS	20-100W RMS	20-120W RMS
<b>Frequency Response</b>	50Hz-25kHz (-6dB on-axis)	50Hz-25kHz (-6dB on-axis)	42Hz-25kHz (-6dB on-axis)
<b>Sensitivity (2.83V@1m)</b>	90dB	87dB	90dB
<b>Nominal Impedance</b>	8ohm	8ohm	8ohm
<b>Crossover Frequency</b>	2900Hz	2800Hz	2900Hz
<b>Inputs</b>	Nickel-plated spring-loaded connectors	Nickel-plated spring-loaded connectors	Nickel-plated spring-loaded connectors
<b>Grille Dimensions</b>	Dia: 9.2in (233mm)	H: 9.8in (248mm) x W 9.8in (248mm)	H: 11.4in (289mm) x W 11.4in (289mm)
<b>Cutout Dimensions</b>	Dia: 8in (203mm)	H: 8.6in (219mm) x W: 8.6in (219mm)	H: 10.2in (260mm) x W: 10.2in (260mm)
<b>Mounting Depth</b>	4.2in (106mm)	5in (127mm)	5.4in (138mm)



# Installation Tools

## Pre-Construction Brackets

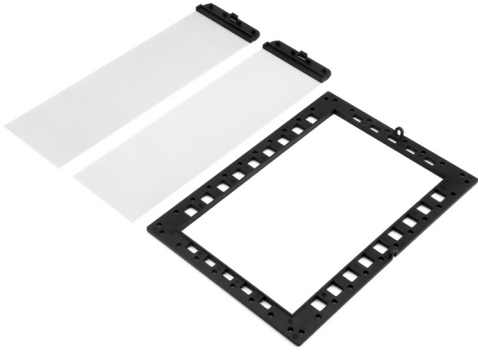
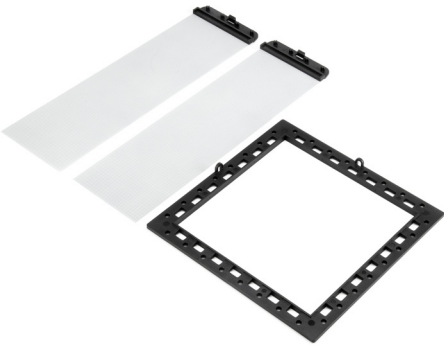
	JBLWB52	JBLWB61 (New)	JBLWB81 (New)	JBLCB6SA	JBLCB8SA
					
<b>Description</b>	Rough-In Bracket for 5" In-Wall	Rough-In Bracket for 6" In-Wall	Rough-In Bracket for 8" In-Wall	Rough-In Bracket for Angled 6" In-Ceiling	Rough-In Bracket for Angled 8" In-Ceiling
<b>Products Supported</b>	250WL	260W	280W	260CSA	280CSA

## Square Grille Kits

	JBLSGK6	JBLSGK8
		
<b>Description</b>	Square White Paintable Grille for 6" In-Ceiling	Square White Paintable Grille for 8" In-Ceiling
<b>Products Supported</b>	260C / 260CDT	280C



Harman International Industries, Incorporated.  
8500 Balboa Blvd, Northridge CA 91329 United States.

**European Representative:** Harman International Industries, Incorporated.  
EMEA Liaison Office, Danzigerkade 16G, 1013 AP Amsterdam, The Netherlands.

**UK Business Address:** Ground Floor, Westside 2, London Road, Apsley, Hemel Hempstead,  
Hertfordshire, HP3 9TD, United Kingdom.

© 2022 Harman International Industries, Incorporated. All Rights Reserved.

JBL is a trademark of Harman International Industries, Incorporated registered in the United States and other countries.

Features, Specifications, and Appearance subject to change without notice.

Part No. 950-0618-001

