

T4 Series Tabletop Touchscreens

Installation Guide



Supported models

- C4-T4T8 8" Tabletop Touchscreen (black or white)
- C4-T4T10 10" Tabletop Touchscreen (black or white)

Introduction

The Control4® T4 Series Tabletop Touchscreens offer complete system control in an elegant, compact, and portable design. The touchscreens are equipped with a full capacitive screen, audio and video Intercom (with the built-in camera) using SIP, and more.

This touchscreen can be located anywhere, and the convenient recharging station enables it to be used as either a tabletop or portable interface. The touchscreen uses an AC power adapter for power and Wi-Fi for network connectivity.

 **Note:** 802.11b is not recommended for video intercom. We recommend using Wireless-N. See "Specifications" for more information.







Box contents

- Tabletop Touchscreen
- Recharging station
- Recharging station power cord

Accessories available for purchase

- Tabletop Permanent Mount Kit (C4-T4PMNT)
- T4 Touchscreen Tabletop 8" Base (C4-T4TBS8)
- T4 Touchscreen Tabletop 10" Base (C4-T4TBS10)

Warnings

-  **Caution!** Do not place the touchscreen near sources of heat or expose to direct sunlight for an extended time.
Avertissement ! Ne placez pas l'unité près des sources de chaleur ou exposition pour diriger la lumière du soleil pendant une période prolongée.
-  **Caution!** This product generates heat. The room must have adequate ventilation or the ability to dissipate heat effectively.
Avertissement ! Ce produit produit de la chaleur. La salle doit avoir à ventilation proportionnée ou la capacité d'absorber la chaleur efficacement.
-  **Caution!** Use this product only in dry locations.
Avertissement ! Employez ce produit seulement dans des endroits secs.
-  **Caution!** Do not use pens or sharp objects to navigate or make selections on the touchscreen. To select an item or scroll through a list, use your fingertip.
Avertissement ! N'employez pas les stylos ou les objets pointus pour diriger ou pour faire des choix sur l'écran. Pour choisir un article ou un rouleau par une liste, employez votre bout du doigt.
-  **Caution!** Improper use or installation can cause DAMAGE OF PROPERTY.
Avertissement ! L'utilisation ou l'installation inexacte peut causer DAMAGE DE PROPRIÉTÉ.
-  **Important!** Using this product in a manner other than outlined in this document voids your warranty. Further, Control4 is NOT liable for any damage incurred with the misuse of this product. See "Warranty."

Specifications and requirements

Specifications

Model Numbers	C4-T4T10-BL, C4-T4T10-WH C4-T4T8-BL, C4-T4T8-WH
Screen	Resolution: 1920 × 1200 Capacitive touch Camera: 720p
Wireless network	802.11b/g/n 2.4 GHz 802.11a/n/ac 5 GHz Security: WEP, WPA/WPA2 PSK, 802.1x EAP, PEAP Notes: (1) While technically the touchscreen can use 802.11b, 802.11b is not supported. (2) 802.11n is recommended for best performance. Even with 802.11n, broadcasting to several devices will degrade Video Intercom response time and images. Broadcasting to additional devices will further degrade performance. See "Wireless Network Limitations."
Power supply	100-240V AC, 50/60 Hz International adapters included Charging base connections: 5V DC power
Dimensions (W×H×D)	8" Touchscreen: 200 × 144 × 23 mm (7.9 × 5.7 × 0.9") 8" Base: 106 × 79 × 56 mm (4.17 × 3.11 × 2.21") 10" Touchscreen: 245 × 172 × 23 mm (9.65 × 6.77 × 0.9") 10" Base: 115 × 102 × 66 mm (4.53 × 4.02 × 2.60")
Weight	8" Touchscreen: 1.05 lb (0.47 kg) 8" Charging base: 1.4 lb (0.64 kg) 10" Touchscreen: 1.35 lb (0.60 kg) 10" Charging base: 1.05 lb (0.46 kg)
Operating temperature	0 to 40 °C (32 to 104 °F)
Storage temperature	-20 to 70 °C (-4 to 158 °F)

Requirements

- A controller fully installed and configured with Control4 OS 3.2.1 or newer.
- A wireless network (IEEE 802.11b/g/n) must be installed and available with a wireless access point (WAP). Security can be WEP, WPA/WPA2 PSK, 801.1x EAP, or PEAP.
- For AC power, you must have access to an AC power outlet (AC power adapter included).

Views

Front



- A** Camera
- B** Camera LED
- C** Light sensor
- D** Stereo microphones
- E** 8" or 10" diagonal, capacitive 1920 × 1200 display

Back (with charging station)



- F** Power button. Press to enter or exit battery saving mode, press and hold to turn off or restart, or press and hold for 10 seconds to power off.
- G** Reset pinhole. Press to reset, or press and hold to reset and restore factory defaults.
- H** Docking connector
- I** Volume buttons
- J** Speakers
- K** Charging station base
- L** 5V DC power connector

Touchscreen placement

Place the touchscreen's charging station on any level surface near a power outlet. You can also use PoE to supply power to an active PoE splitter's DC jack. For more information on mounting the touchscreen, see "Portable" under "Mounting options" below.

 **Note:** Consider the angle of the touchscreen's camera and the sitting or standing position of the people who will use it while it's on the charging station.

Connect power and Wi-Fi

The touchscreen uses a Wi-Fi network connection, so it can be positioned anywhere in the home with a strong WiFi signal and access to a power outlet.

To connect power and Wi-Fi:

- 1 Place the touchscreen's charging station near a power outlet.
- 2 Connect the AC power adaptor to a power outlet and the charging station.
- 3 Make sure you have Wi-Fi working in the home.

If a home requires a large number of Wi-Fi video intercom devices, ensure that you have a robust Wi-Fi network (possibly consisting of multiple access points).

 **Connection notes:** This device supports 802.11b/g/n/ac. We recommend Wireless-N or Wireless-AC for best video intercom performance.

Wireless network limitations: Many Wi-Fi access points handle Multicasts (Wi-Fi simultaneously sent to multiple devices, for example, when the touchscreen broadcasts video to all stations) by slowing down transmission speed to the 1 Mb basic rate. This can cause overall Wi-Fi congestion in the Wi-Fi network during the broadcast. Video Intercom response times and images may degrade at each device.

Connect to Wi-Fi

To set up Wi-Fi on the touchscreen:

- 1 After the touchscreen starts up, tap **Network**. The network configuration page opens.
- 2 Under *Wi-Fi*, make sure Wi-Fi is enabled, then tap the **Wi-Fi** field to open a list of available networks.
- 3 Tap the network name you want to connect to.
- 4 Tap the **Password** field, then use the on-screen keyboard to type the password (if required).

 **Note:** If you need to enter a static IP address, follow the instructions under "To set a wireless static IP address" below before proceeding.

- 5 Tap **Connect**.

If you don't see the network you want:

- 1 Tap **+**, then tap the **Network SSID** field and type the SSID (name) of the network by using the on-screen keyboard.
- 2 Tap the **Security** field, then select the type of security to use.
- 3 Tap the **Password** field, then use the on-screen keyboard to type the password (if required).

 **Note:** If you need to enter a static IP address, follow the instructions under "To set a wireless static IP address" below before proceeding.

- 4 Tap **Save**. The new network is added to the bottom of the network list.

To set a wireless static IP address:

- 1 Scroll down and tap **Show advanced options**.
- 2 Tap **IP settings**, then tap **Static**.
- 3 Select each box one at a time and use the on-screen keyboard to type the:
 - **IP address**
 - **Gateway**
 - **Network prefix length**
 - **DNS 1** (preferred)
 - **DNS 2** (alternate)

Add and configure in Composer Pro

After the touchscreen is installed and appears on the home network, use Composer Pro to add it to the Control4 system and configure it.

Use the Composer Pro *System Design* and *Connections* views to add and configure this device.

To add and configure a T4 touchscreen to a project:

- 1 Add the **T4 Tabletop Touchscreen** driver to your project.
- 2 Identify the device to the project, select the touchscreen in Composer Pro's **Connections > Network** view, click **Identify**, then tap **Identify** on the touchscreen.
- 3 To configure the properties, select the touchscreen in the **System Design** view, then view and change the properties in the *Properties* pane as needed.

Properties include:

- **Network Connection**—Reports the touchscreen's current network connection type.
- **Back Light**—Click the arrows or type numbers to set the light level, then click **Set**.

Advanced properties include:

- **Enable Camera**—Allows you to enable or disable the camera.

Intercom properties (nested under the touchscreen):

- **Appearance**—Select to hide the touchscreen from appearing in Navigators as an available device.
- **Behavior**—Select the modes you want this touchscreen to support.
- **Audio Control**—Select the volume of individual audio settings.

- **Sip Information**—Information for integrating the touchscreen into your SIP/VoIP system.
- **Custom Buttons**—Select to enable and label the two available custom buttons.
- **Alternate Camera**—Select to use an external camera for the video associated with the touchscreen, for example, a security camera mounted to the side of the entrance and pointing at the door.

Mounting

Place the charging station on any level surface. While positioning the touchscreen, consider the angle of the touchscreen's camera and the position of the people who will use it while it's on the charging station.

Portable use

You can set the touchscreen onto the charging station for recharging and tabletop use, and lift the screen from the charging station for portable use (like a tablet).

Tip: For easy and smooth separation of the touchscreen from the charging station, slightly rotate the touchscreen while lifting it.

Permanent mount

You can mount a touchscreen permanently to a surface, such as a table, using the optional T4 Tabletop Permanent Mount Kit (C4-T4PMNT).

- 1 Peel off the plastic cover on the touchscreen's docking connector recess.

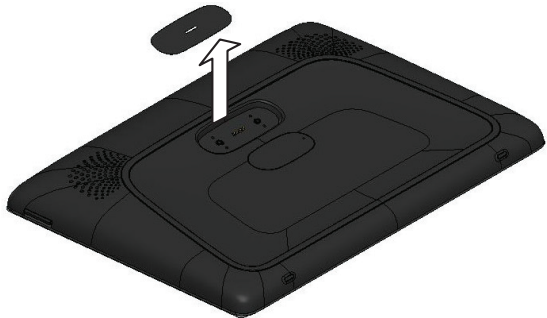

- 2 Use the Phillips-head flat screws provided in the kit to install the permanent-mount adapter into the touchscreen's docking connector recess.

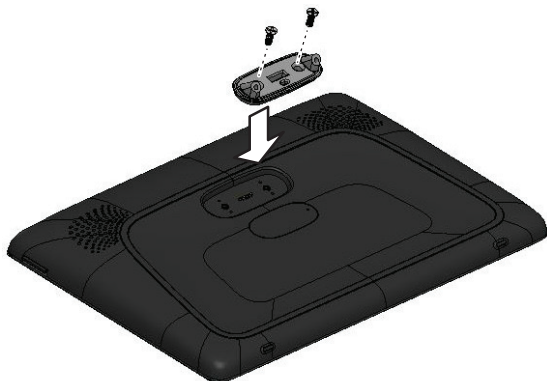

- 3 Remove the charging station's bottom cover by removing the two screws shown.

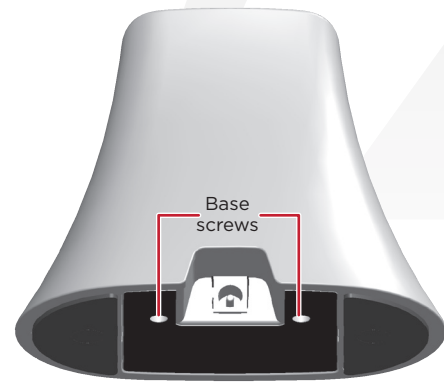

- 4 Save the cover and screws.



- 5 Using a #2 Phillips screwdriver inserted from the base of the charging station, remove the two screws that secure the charging station's top docking connector cover (do not remove the screw holding the PCB), then discard the two screws you removed.

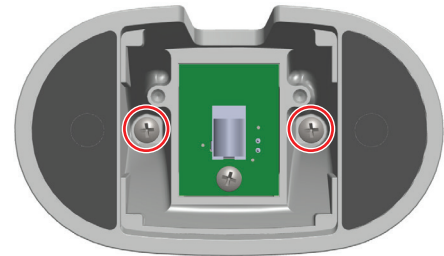

- 6 Screw the base to the back of the touchscreen as shown using the new threaded, black screws provided. DO NOT ATTEMPT TO USE THE ORIGINAL SCREWS REMOVED IN STEP 5 OR YOU WILL PERMANENTLY DAMAGE THE THREADS ON THE TOUCHSCREEN.



- 7 Reinstall the base bottom cover.

8 To install the charging station permanently into a table or countertop, remove the small rubber discs covering the threaded holes in the base.



9 Install the threaded posts (all thread) into the base of the charging station.



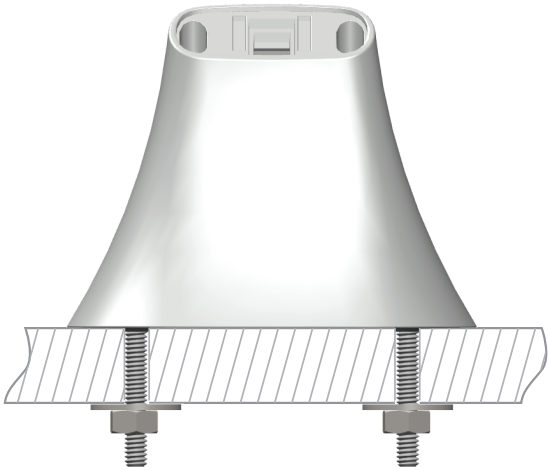

10 Using the template and a 1/4" drill, drill two holes into the surface where you are mounting the touchscreen. Maximum surface thickness is 32 mm (1.25").

11 Mount the charging station assembly into the mounting holes and secure it in place using a washer and nut.



Troubleshooting

To power cycle the touchscreen:

- 1 Press and hold the  (power) button for at least 10 seconds until the touchscreen turns off.
- 2 If it doesn't turn back on automatically, press and release the  (power) button again to turn it on.

To perform a factory data reset:

- 1 On the touchscreen's main screen, tap **Settings, System Info**, then **Factory data reset**.

- OR -

If the touchscreen has not yet been configured, tap **About**, then **Factory data reset**.

- OR -

To restore defaults without using the display screen, press and hold the reset pinhole button until "Erasing" appears on the screen.



Reset hole



Additional resources

The following resources are available for more support.

- Knowledgebase and forums on Tech Community
- Technical Support
- Control4 website: www.control4.com
- Composer documentation available at ctrl4.co/docs.

Warranty and legal notices

Find details of this product's 2-Year Limited Warranty at snapav.com/warranty, or request a paper copy from Customer Service at (866) 424-4489. Find other legal resources, such as regulatory notices and patent information, at snapav.com/legal.

More help

For the latest version of this document, open this URL or scan the QR code on a device that can view PDFs.

LATEST VERSION OF THIS DOCUMENT

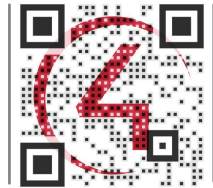

ctrl4.co/t4-tabletop-ig

T4 DATA SHEET

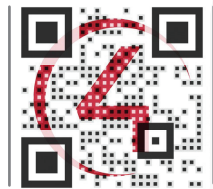

ctrl4.co/t4-ds



control4.com | 888.400.4070

Copyright ©2020, Wirepath Home Systems, LLC. All rights reserved. Control4 and Snap AV and their respective logos are registered trademarks or trademarks of Wirepath Home Systems, LLC, dba "Control4" and/or dba "SnapAV" in the United States and/or other countries. Snap AV and Wirepath are also registered trademarks or trademarks of Wirepath Home Systems, LLC. Other names and brands may be claimed as the property of their respective owners. All specifications subject to change without notice.

B

200-00683-B
2020-11-11 MS