

TRIAD INSTALLATION GUIDE - 4-ZONE AND 8-ZONE POWER AMPLIFIER

INTRODUCTION

The Triad 4-Zone and 8-Zone Power Amplifiers deliver high-performance, reliability, and robust amplification in a compact form factor—providing the perfect solution for distributed audio systems. Fast wake-from-standby time and high-resolution audio quality output make this amplifier worthy of any audio solution. Seamless integration with the Triad Audio Matrix Switches and other Triad Power Amplifiers provides you with an easily configurable, fully featured audio distribution solution for any size home.

SUPPORTED MODELS

- TS-PAMP8-100 Triad 8-Zone Power Amplifier
- TS-PAMP4-100 Triad 4-Zone Power Amplifier





BOX CONTENTS

- 4 or 8-Zone Power Amplifier
- IEC power cable
- Phoenix-style speaker connectors
- Rack-mount ears and screws
- Mono 3.5 mm 12V trigger cable

FEATURES

- Powerful amplification driven by ICEpower modules delivers a dynamic, high-resolution audio experience
- Class-D amplification runs cool allowing you to stack one amplifier on top of the other
- Bridgeable outputs provide double the amplification for areas that require more amplifier power
- 1U height takes up half the rack space of other multi-room amplifiers
- Fast wake from standby using 12V trigger from Triad Audio Matrix Switches—ideal for time-sensitive audio announcements and quick audio zone turn on
- Standby mode saves energy by muting audio when not in use
- Three power control options—12V trigger, audio sensing, or always on
- Global input allows a single audio input to be linked to multiple amplifier outputs with a simple dip switch
- Global output allows you to chain multiple amplifiers together to create large audio zones
- Over-current protection prevents amplifier channels from overloading due to short circuits or incorrect wiring
- Thermal protection shuts down amplifier channels if thermal limits are exceeded, preventing damage

WARNINGS

-  **WARNING!** Do not expose the apparatus to dripping or splashing. Do not place objects filled with liquids near the apparatus.
AVERTISSEMENT ! N'exposez pas l'appareil à l'égoutture ou à l'éclaboussement. Ne placez pas les objets remplis de liquides près de l'appareil.
-  **WARNING!** To reduce the risk of fire or electrical shock, do not expose this apparatus to rain or moisture.
AVERTISSEMENT ! Pour réduire le risque du feu ou de choc électrique, n'exposez pas cet appareil à la pluie ou à l'humidité.
-  **IMPORTANT!** Using this product in a manner other than outlined in this document voids your warranty. Further, Control4 is NOT liable for any damage incurred with the misuse of this product. See "Warranty."
- IMPORTANT !** Employer ce produit en quelque sorte autre que décrit dans ce document vide votre garantie. De plus, Control4 n'est pas responsable d'aucun dommage encouru avec l'abus de ce produit. Voyez que « garantie. »
-  **IMPORTANT!** Do not defeat the safety purpose of the polarized or grounding-type plug. The wide blade or the third prong are provided for your safety. If the provided plug does not fit into your outlet, consult an electrician for replacement of the obsolete outlet.
-  **WARNING!** To reduce the risk of fire, do not install this device in a cabinet that is smaller than 20" (50.8 cm) wide × 20" (50.8 cm) deep × 12" (30.5 cm) high. If you do, the device may overheat.
AVERTISSEMENT ! Pour réduire les risques d'incendie, ne pas installer cet appareil dans une armoire qui est plus petit que 20" (50.8 cm) de large × 20" (50.8 cm) de profondeur × 12" (30.5 cm) de haut. Si vous le faites, l'appareil peut surchauffer.

FRONT AND REAR PANEL DESCRIPTIONS

FRONT PANEL 4-ZONE AND 8-ZONE AMPLIFIERS

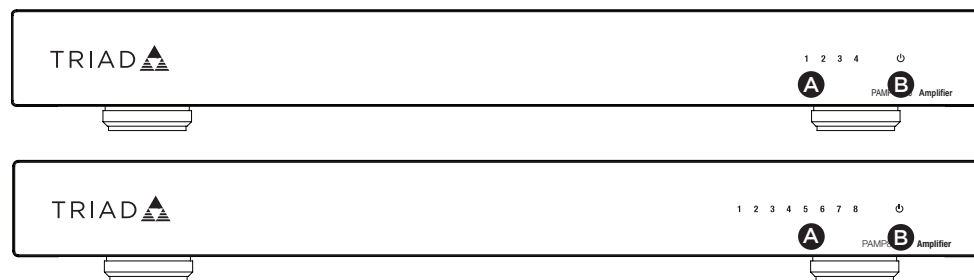

- A Zone Status LEDs**—Lights blue when an amplifier zone is on, red if in overcurrent protection, and orange if in thermal shutdown
- B Power LED**—Lights blue when amplifier powers on.

BACK PANEL 4-ZONE AND 8-ZONE AMPLIFIER

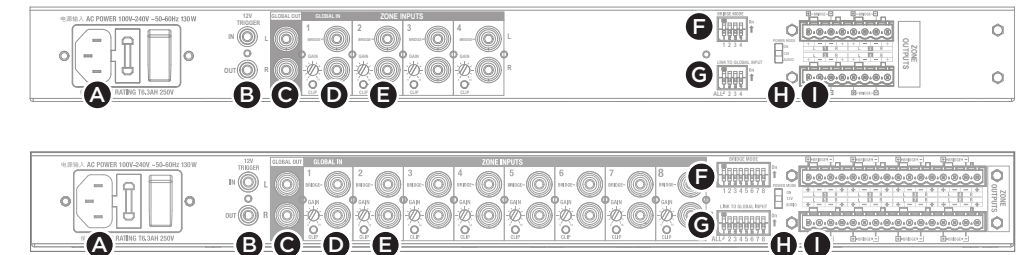

- A Power connector**—Use the supplied power cord to connect power.
- B 12V TRIGGER IN/OUT**—Trigger input for 12V control of amplifier power. Connects to trigger output of audio matrix or other 12V trigger device. Trigger output chains 12V control to another amplifier trigger input.
- C GLOBAL OUT**—RCA connectors for a global line-level stereo audio out. Outputs whatever audio device is plugged into Zone 1 Input/GLOBAL IN.
- D Zone 1 input/GLOBAL IN**—RCA connectors for stereo line in. Can be used as a global audio input or input for zone 1. **GAIN** dial is used to adjust input level for zone 1 or global in. The recommended starting gain level is 6. **CLIP** LED turns red when input gain is too high, causing the amplifier zone to clip.
- E Zone 2-4 (8) input**—RCA connectors for stereo line in for zones 2-4 (8). **GAIN** dial is used to adjust input level for each zone. The recommended starting gain level is 6. **CLIP** LED turns red when input gain is too high for each zone, causing the amplifier zone to clip.
- F BRIDGE MODE**—Set switches to **On** to bridge left/right amplifier channels for a zone. When channels are bridged, use the RCA input labeled **BRIDGE**.
- G LINK TO GLOBAL INPUT**—Set switches to **On** to link a zone to the **GLOBAL IN** or set the **ALL** switch to **On** to link all zones to the **GLOBAL IN**.
- H POWER MODE**—Set to **ON/12V/AUDIO** to configure the amplifier's power setting.
- I ZONE OUTPUTS**—4 (8) stereo zone outputs using 4 (8) stereo Phoenix-style connectors for speaker wiring connections.

TRIAD INSTALLATION GUIDE - 4-ZONE AND 8-ZONE POWER AMPLIFIER

INSTALLING THE AMPLIFIER

The 4-Zone and 8-Zone Power Amplifiers come with rack-mount ears and can be installed in a 1U rack space.

Installing the 4-Zone and 8-Zone Power Amplifiers in a rack:

- 1 Attach the rack ears to the sides of the amplifier using the provided screws.

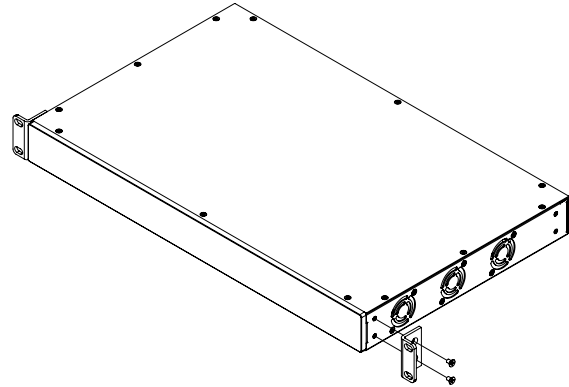

Note: Rack ears can be installed to the front or the back of the amplifier as needed.

- 2 Install into rack and connect cabling.

CAUTION! To prevent damage, maintain adequate ventilation space to the sides of the amplifier. Amplifiers can be stacked vertically, but be sure not to place the amplifier next to other components or against the side of a cabinet. Doing so will block ventilation openings.

ATTENTION ! Pour éviter tout dommage, maintenir un espace de ventilation adéquate sur les côtés de l'amplificateur. Les amplificateurs peuvent être empilés verticalement, mais veillez à ne pas placer l'amplificateur à côté d'autres composants ou sur le côté d'une armoire. Cela évitera de bloquer les ouvertures de ventilation.

CONNECTING THE AMPLIFIER

This device is designed to operate as part of the Control4 home system which requires physical audio connections and connections in Composer Pro to function as designed. This section describes how to set up the physical connections required for the amplifier and some of the devices associated with it.

WARNING! Connecting speaker wires or input cables while the amplifier is powered may cause electrical shock and could damage the amplifier. Unplug the power cord before making connections.

AVERTISSEMENT ! Les fils se reliant de haut-parleur ou les câbles entrés tandis que l'amplificateur est actionné, peuvent causer le choc et pourraient endommager l'amplificateur. Débranchez le cordon de secteur avant d'établir des rapports.

CONNECTING AUDIO INPUTS

The 4-Zone and 8-Zone Power Amplifiers accepts stereo line-level audio connections to their inputs jacks. Each zone input will pass amplified audio to the respective zone speaker output. Alternatively, each zone can be linked individually to the **GLOBAL IN** (shared with input 1).

- 1 Connect the audio cables to the **ZONE INPUTS (1-8)** audio input jacks.

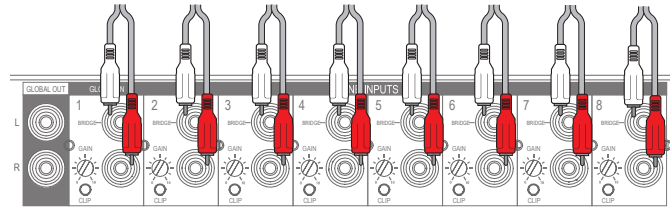

- 2 (Optional) Connect the audio cable to **GLOBAL IN** (input 1) and link speaker outputs to the **GLOBAL IN** by moving the dip switch up for that zone to the **On** position.

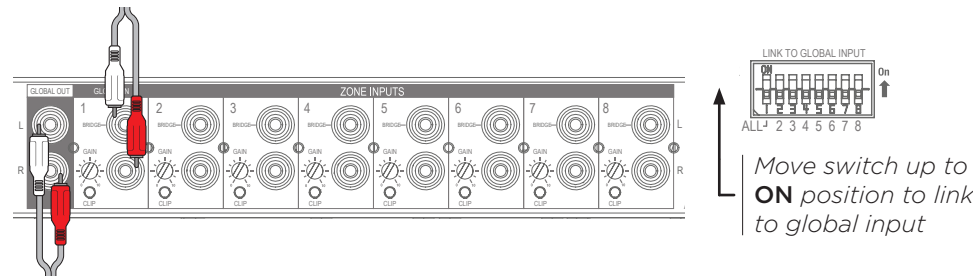

Note: The first switch on LINK TO GLOBAL INPUT is labeled **ALL**. Set this switch to **On** to link every output of the amplifier to GLOBAL IN (input 1).

- 3 (Optional) Connect an audio cable to the **GLOBAL OUT** to duplicate the audio source connected to the **GLOBAL IN** and pass that audio to another amplifier.

CONNECTING SPEAKERS

The 4-Zone and 8-Zone Power Amplifiers can power four (or eight) stereo zones of audio and has phoenix-style terminal blocks for speaker connections. Speakers can also be wired to bridge channels to increase the power available to the speakers.

To connect stereo speakers:

- 1 Remove the speaker connector.
- 2 Connect speaker wire to the speaker connector and reinsert the speaker connector into the amplifier.

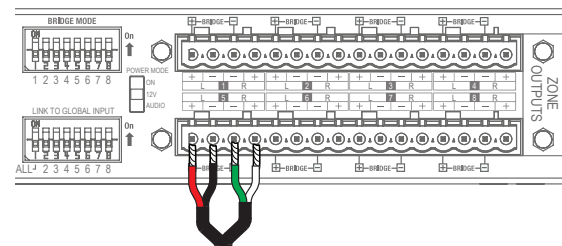

IMPORTANT! The common signal of these speaker outputs must not be connected together or to any other common signal. Do not connect the **L -** and **R -** (negative) terminals together. Doing so will result in a fault condition and the amplifier will either shut down or not work properly.

CAUTION! Check the polarity of the speakers and wires before connecting to the amplifier.

ATTENTION ! Vérifiez la polarité des enceintes et des câbles avant de brancher à l'amplificateur.

To connect bridged speakers:

- 1 Set the **BRIDGE MODE** dipswitch, if needed, for each zone by moving the dip switch up for that zone to the **ON** position.



- 2 Connect **+** terminal from the speaker to the **+** terminal of the left channel (**L**).

- 3 Connect the **-** terminal from the speaker to the **-** terminal of the right channel (**R**) on the amplifier.

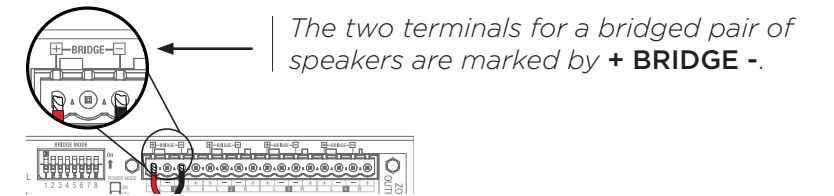

In bridged mode, both amplifier channels will output the same audio. A mono source can be connected to the **Bridge** input to create a bridged mono output, or a stereo source can be connected to two **Bridge** inputs (using two zones) to create a bridged stereo output.

SETTING UP THE AMPLIFIER POWER MODE

The 4-Zone and 8-Zone Power Amplifiers can be set up to automatically power on when needed. The **POWER MODE** switch allows the amplifier to be powered on at all times, turned on with a 12V trigger, or turned on when an audio signal is present at any audio input.

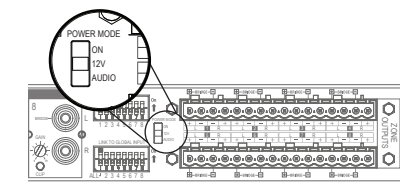

To set up the amplifier to be always on:

- 1 Slide the **POWER MODE** switch to **ON**.

In this mode, the amplifier will be always on unless the power cord is unplugged or the power switch by the power cord is toggled off.

TRIAD INSTALLATION GUIDE - 4-ZONE AND 8-ZONE POWER AMPLIFIER

To set up the amplifier to be controlled by a 12V trigger:

- Slide the POWER MODE switch to **12V**.
- Connect the 12V trigger cable from the trigger device to **12V TRIGGER IN**.

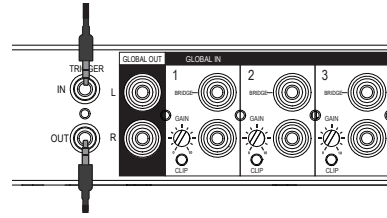

- (Optional) Connect **12V TRIGGER OUT** to another amplifier to link their power control together.

In this mode, the amplifier will turn on when a 12V signal is present on the 12V Trigger Input jack. This 12V trigger input can be wired to the 12V trigger output of a Triad audio matrix switch or a relay and contact on a Control4 controller. See the Control4 Knowledgebase for more details

NOTE: All amplifier zones turn on when a 12V trigger is received in 12V Power Mode.

To set up the amplifier to be turned on by the audio sensing:

- Slide the POWER MODE switch to **AUDIO**.

In this mode, the amplifier will turn on when an audio signal is sensed on the audio input.

NOTE: Only the amplifier zone that senses audio will turn on when in Audio Power Mode.

TROUBLESHOOTING

RESETTING THE AMPLIFIER

- Power reset**—Remove the power cord and replace the power cord to power cycle the device.

NOTE: If the amplifier will not turn on, check the Power Mode switch. Try changing the Power Mode switch to **ON**.

LED TROUBLESHOOTING GUIDE

Zone Status LED	Power LED	Description
		Amplifier is powered on, in standby
		Amplifier zone(s) are on
		Zone(s) are in over-current protection
		Zone(s) are in thermal shutdown

SPECIFICATIONS

	8-ZONE	4-ZONE
GENERAL		
Triad Power Amplifier	TS-PAMP8-100	TS-PAMP4-100
Audio inputs	8 stereo, RCA style	4 stereo, RCA style
Global audio input	1 stereo analog (shared with zone 1 input)	1 stereo analog (shared with zone 1 input)
Global audio output	1 stereo analog (from shared zone 1 input)	1 stereo analog (from shared zone 1 input)
Zone speaker outputs	8 stereo outputs	4 stereo outputs
Global input	8 × 2-position dip switches	4 × 2-position dip switches
Bridge mode	8 × 2-position dip switches	4 × 2-position dip switches
12V trigger control	1 × 3.5 mm (in) 1 × 3.5 mm (out)	1 × 3.5 mm (in) 1 × 3.5 mm (out)
Power mode switch	1 × 3-position switch—always on, 12V, or audio sense	1 × 3-position switch—always on, 12V, or audio sense
Wake from standby	<2 seconds with 12V trigger -3 seconds with audio sense	<2 seconds with 12V trigger -3 seconds with audio sense
Standby power consumption	Less than 0.50W	Less than 0.50W
RATED WATTAGE		
2 channels driven	100W per channel @ 4 Ω 50W per channel @ 8 Ω	100W per channel @ 4 Ω 50W per channel @ 8 Ω
Minimum impedance	2.5 Ω	2.5 Ω
RATED WATTAGE BRIDGED		
1 bridged output	200W @ 8 Ω	200W @ 8 Ω
AUDIO		
Frequency response	±0.4 dB, 10 Hz - 20 kHz, all loads	±0.4 dB, 10 Hz - 20 kHz, all loads
Dynamic range	110 dBA SE, 115 dBA BTL	110 dBA SE, 115 dBA BTL
Idle noise	45 uV, A-weighted, 20 Hz - 20 kHz, SE	45 uV, A-weighted, 20 Hz - 20 kHz, SE
Upper bandwidth, -3 dB	100 kHz, 4 Ω, SE	100 kHz, 4 Ω, SE
Input impedance	47 kΩ, f=1 kHz	47 kΩ, f=1 kHz
Output serial impedance	42 mΩ, f≤1 kHz, SE	42 mΩ, f≤1 kHz, SE
THD	0.003%, 4 Ω, SE, f=100 Hz, Po=1W	0.003%, 4 Ω, SE, f=100 Hz, Po=1W
POWER		
AC mains power	Universal mains 100 - 240VAC 50 - 60 Hz	Universal mains 100 - 240VAC 50 - 60 Hz
Fuse rating	6.3A	6.3A
Power connection	IEC 320 C13 power connector with 3-pole detachable power cord	IEC 320 C13 power connector with 3-pole detachable power cord
THERMAL		
Operating temperature	32 °F - 113 °F (0 °C - 45 °C)	32 °F - 113 °F (0 °C - 45 °C)
Humidity	5% to 95% non-condensing	5% to 95% non-condensing
Storage	-4 °F - 158 °F (-20 °C - 70 °C)	-4 °F - 158 °F (-20 °C - 70 °C)

Thermal dissipation	Three fans mounted in the left side	Three fans mounted in the left side
Thermal dissipation (heat losses)	0.23W / 0.8 BTU/hr, standby 40W / 136.5 BTU/hr, idle, all channels 100W / 341 BTU/hr, max output, all ch. driven	0.23W / 0.8 BTU/hr, standby 25W / 85.3 BTU/hr, idle, all channels 100W / 341 BTU/hr, max output, all ch. driven
MISCELLANEOUS		
Mains switch w/ changeable fuse	Yes	Yes
Speaker outputs	8 × 4-position Phoenix-style connectors	4 × 4-position Phoenix-style connectors
Input gain potentiometer	1 for each zone	1 for each zone
Clip Indicator LEDs	1 for each zone (back panel)	1 for each zone (back panel)
H × W × D (with feet)	2.13 × 17.5 × 11.44" (5.3 × 44 × 29 cm)	2.13 × 17.5 × 11.44" (5.3 × 44 × 29 cm)
H × W × D (without feet)	1.75 × 17.5 × 11.44" (4.4 × 44.5 × 29 cm)	1.75 × 17.5 × 11.44" (4.4 × 44.5 × 29 cm)
Front panel power LED	1 × blue LED	1 × blue LED
Front panel zone status LED	1 RGB LED for each zone	1 RGB LED for each zone

REGULATORY/SAFETY INFORMATION

To review regulatory information for your particular Triad products, see the information located on the Triad website at triadspkrs.co/reg.

WARRANTY

Limited 2-year Warranty. Go to triadspkrs.co/warranty for details.

Copyright ©2020, Wirepath Home Systems, LLC. All rights reserved. Control4 and Snap AV and their respective logos are registered trademarks or trademarks of Wirepath Home Systems, LLC, dba "Control4" and/or dba "SnapAV" in the United States and/or other countries. 4Store, 4Sight, Control4 My Home, Snap AV, Triad, and Wirepath are also registered trademarks or trademarks of Wirepath Home Systems, LLC. Other names and brands may be claimed as the property of their respective owners. All specifications subject to change without notice.

