

LYNGDORF AUDIO TDAI-1120

OWNER'S MANUAL

DK: For seneste version af denne manual og yderligere hjælp på dit lokale sprog, venligst besøg www.steinwaylyngdorf.com eller kontakt os på contact@lyngdorf.com

NO: For den nyeste versjonen av denne håndboken og ytterligere hjelp på ditt lokale språk vennligst besøk www.steinwaylyngdorf.com eller kontakt oss på contact@lyngdorf.com

SE: Gå till www.lyngdorf.com eller kontakta oss på contact@lyngdorf.com för den senaste versionen av denna handbok för och ytterligare hjälp på ditt språk.

FI: Saat uusimmat käsikirjaversio ja lisäapua omalla kielellä osoitteessa www.steinwaylyngdorf.com tai yhteyttä osoitteeseen contact@lyngdorf.com

NL: Voor de meest recente versie van deze handleiding en verdere hulp in uw eigen taal kunt u terecht op www.steinwaylyngdorf.com of neem contact met ons op via contact@lyngdorf.com

PL: W celu uzyskania najnowszej wersji tej instrukcji obsługi oraz dalszej pomocy w Twoim języku, odwiedź www.lyngdorf.com lub skontaktuj się z nami pod adresem contact@lyngdorf.com.

IT: Per ottenere l'ultima versione del presente manuale e ulteriore supporto nella lingua locale, visitare il sito www.acme.com o scrivere all'indirizzo contact@acme.com

ES: Para descargar la última versión de este manual de ayuda y otros recursos en su idioma local, visite la web www.acme.com o póngase en contacto con nosotros en el email contact@acme.com

CZ: Nejnovější verzi této příručky a další pomoc ve vašem místním jazyce naleznete na stránkách www.lyngdorf.com nebo nás kontaktujte na contact@lyngdorf.com

RU: Для получения последней версии этого руководства и консультаций на русском языке зайдите на сайт www.lyngdorf.com или свяжитесь с нами по адресу: contact@lyngdorf.com

Contents

OWNER’S MANUAL..... 1

Welcome..... 6

Compliance..... 7

 WEEE..... 7

 FCC..... 7

Important safety instructions..... 8

 Warnings 8

 Explanation of graphical symbols..... 8

 Important safety instructions 8

What is in the box..... 11

Back panel guide..... 11

Front panel guide..... 13

How to get started 15

 Connecting speakers..... 15

 Tips for setting up speakers 15

 Speaker placement with RoomPerfect™ 16

Connecting a subwoofer..... 17

Turning on the TDAI-1120 for the first time 18

 Network connection by cable (recommended)..... 18

 Establishing Wi-Fi connection 18

 Wi-Fi procedure with iPhone or iPad (active immediately upon turning on)..... 18

 Wi-Fi procedure with Android 18

 Manual Wi-Fi procedure (WPS) 19

 Factory reset 20

How to use the TDAI-1120 21

Lyngdorf Remote app..... 22

TDAI-1120 setup page 24

Finalizing the setup..... 25

Setup menu 27

 Input setup..... 27

Output setup 29

 Delays: 30

 Measuring distances 30

 Amplifier delay:..... 31

Main speaker output:	32
Analog output:	32
Low or High pass crossover filters:	32
RoomPerfect™ setup	34
RoomPerfect™ guide	34
Handle focus positions	34
Add room measurement	34
Placing the microphone in the focus position	35
Measuring the focus position	35
Measuring random room positions	35
Room measurements above 90% RoomKnowledge	36
RoomPerfect™ troubleshooting	36
Voicing setup	38
Audio setup	38
HDMI setup	38
Streaming setup	39
Chromecast built-in™	39
Spotify Connect	40
Roon	40
Airplay2	40
Bluetooth	40
UPnP	40
USB	40
vTuner	41
Presets	41
Tidal Connect	41
MQA	41
Playing MQA files	41
General setup	42
Manage software	42
Backup	42
Restore	42
Factory reset:	43
Download system log	43
Update software	43
To update the TDAI-1120:	43
Cleaning and maintenance	44
Control Manual	44

Technical assistance45

Welcome

Congratulations on your purchase of the Lyngdorf Audio TDAI-1120 fully digital amplifier with Room- Perfect™. With this purchase, you have joined the ranks of an elite group of people who believe that perfect sound is more than a luxury. It's a requirement. The TDAI-1120 will deliver an audio experience that will far exceed your expectations. We thank you for placing your confidence in Lyngdorf Audio.

This manual will give you an overview of how to set up your system. Please read the manual carefully to better understand the capabilities of your TDAI-1120. For more in-depth information about the technologies used in Lyngdorf Audio products, please visit www.steinwaylyngdorf.com.

Compliance

WEEE

The European Parliament and the Council of the European Union have issued the Waste Electrical and Electronic Equipment Directive. The purpose of the Directive is to prevent waste of electrical and electronic equipment and to promote reuse, recycling, and other forms of waste recovery. Lyngdorf products and the accessories packed with them are subject to the WEEE Directive. Please dispose of any waste materials in accordance with your local recycling regulations. Products and equipment which must be collected for reuse, recycling, and other forms of recovery are marked with the icon of the crossed-out waste receptacle.



FCC

Lyngdorf products and accessories comply with parts 15 and 68 of the FCC rules. Operation is subject to the following two conditions: (1) this device may not cause harmful interference; and (2) this device must accept any interference received, including any interference that may cause undesired operation.

Changes or modifications not expressly approved by the party responsible for compliance could void the user's authority to operate the equipment. Equipment marketed to a consumer must can comply with the necessary regulations in the configuration in which the equipment is marketed.

Apple Airplay

Use of the Works with Apple badge means that an accessory has been designed to work specifically with the technology identified in the badge and has been certified by the developer to meet Apple performance standards.

AirPlay is a trademark of Apple Inc., registered in the U.S. and other countries.

Chromecast built-in is a trademark of Google LLC.

Android, Google Home and Chromecast built-in are trademarks of Google LLC.

Important safety instructions

Warnings



Caution: Risk of electrical shock. Do not open.

Caution: To reduce the risk of electrical shock, do not remove cover. No user-serviceable parts inside. Refer servicing to qualified personnel.

Explanation of graphical symbols



The exclamation point within an equilateral triangle is intended to alert the user to the presence of important operating and maintenance (servicing) instructions in the literature accompanying the product.



The lightning with arrowhead symbol within an equilateral triangle is intended to alert the user to the presence of uninsulated “Dangerous Voltage” within the products’ enclosure that may be of sufficient magnitude to constitute a risk of electrical shock to a person.

Important safety instructions

1. Read and keep these instructions.
2. Heed all warnings. / Follow all instructions.
3. Clean only with a dry cloth.
4. Ensure that the ventilation is not impeded by covering the ventilation openings with items such as newspapers, table- cloths, curtains, etc. Ensure a minimum distance of 5 cm around the apparatus for sufficient ventilation
5. Do not install near any heat sources such as radiators, stoves, or other apparatus (including amplifiers) that produce heat.
6. Do not defeat the safety purpose of the polarized or grounding-type plug. A polarized plug has two blades with one wider than the other. A grounding-type plug has two blades and a third grounding prong. The wire blade or the third prong is provided for your safety. If the provided plug does not fit into your outlet, consult an electrician for replacement of the obsolete outlet.
7. Protect the power cord from being walked on or pinched, particularly at plugs, convenience receptacles, and the point where they exit from the apparatus.
8. Only use attachments/accessories specified by the manufacturer.

9. Use only with cart, stand, tripod, bracket, or table specified by the manufacturer, or sold with the apparatus. When a cart is used, use caution when moving the cart/apparatus combination to avoid injury from tip-over.
10. Unplug this apparatus during lightning storms or when unused for long periods of time.
11. Refer all servicing to qualified service personnel. Servicing is required when the apparatus has been damaged in any way, such as power-supply cord or plug is damaged, liquid has been spilled or objects have fallen into the apparatus, the apparatus has been exposed to rain or moisture, does not operate normally or has been dropped.
12. The mains plug is used as a disconnect device and shall remain readily operable.
13. Do not connect any output from the amplifier to any other amplifier's output or any other voltage sources.
14. Do not expose this apparatus to dripping or splashing and ensure that no objects filled with liquids, such as vases, are placed on the apparatus. Do not use this apparatus near water.
15. To avoid electrical shock, make sure that no conductive part of the loudspeaker wiring is exposed while the amplifier is operating. Do not connect loudspeakers with uninsulated terminals to the amplifier.
16. Connect only to the proper mains voltage.
17. This apparatus must be connected to a mains socket outlet with a protective earthing connection.
18. Warning: Batteries (battery pack or batteries installed) shall not be exposed to excessive heat /sunshine, fire or the like.
19. Warning: To reduce the risk of fire or electric shock, do not expose this apparatus to rain or moisture.
20. Do not place naked flame sources, such as lighted candles on the apparatus.
21. Use the apparatus only in moderate climates (not in tropical climates).
22. CLASS I apparatus which is intended for connection to the building installation wiring via a plug or an appliance coupler, or both and in addition is intended for connection to other apparatus or a network shall, if safety relies on connection to protective earth or if surge suppressors are connected between the network TERMINALS and ACCESSIBLE parts, have a marking stating that the apparatus must be connected to an earthed MAINS socket-outlet.

23. Take attention to the environmental aspects of battery disposal. Do not dispose of batteries in household waste.

DK: Apparatets stikprop skal tilsluttes en stikkontakt med jord, som giver forbindelse til stikproppens jord.

FI: Laite on liitettävä suojakoskettimilla varustettuun pistorasiaan. NO:

Apparatet må tilkoples jordet stikkontakt.

SE: Apparaten skall anslutas till jordat uttag.

FR: Lorsque la prise du réseau d'alimentation est utilisés comme dispositif de déconnexion, ce dispositif doit demeuré aisément accessible. L'appareil ne doit pas être exposé à des egouttements d'eau ou des éclaboussures et de plus qu'aucun objet rempli de liquide tel que des vases ne doit pas être placé sur l'appareil. Cet appareil doit être raccordé à une prise de courant qui est branchée à la terre.

Un avertissement salon lequel les batteries (bloc de batteries ou batteries installées) ne doivent pas être exposées à une chaleur excessive telle que celle du soleil, d'un feu ou d'origine similaire. Avertissement: Pour réduire le risque d'incendie et de décharge électrique l'appareil ne doit pas être exposé à l'eau ou à l'humidité.

What is in the box

TDAI-1120

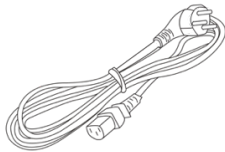
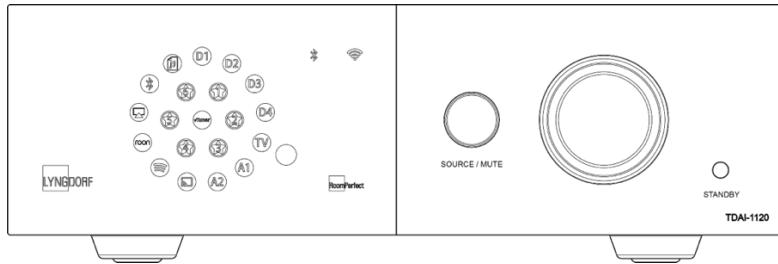

Mains cord

- Universal Mains detection
- Mains Inlet: IEC320



8 m (26 feet) XLR – Microphone cable



RoomPerfect™ microphone



Microphone stand

For full installation you will need loudspeakers and loudspeaker cables.
For integration with television sound you will need an HDMI cable.

Back panel guide

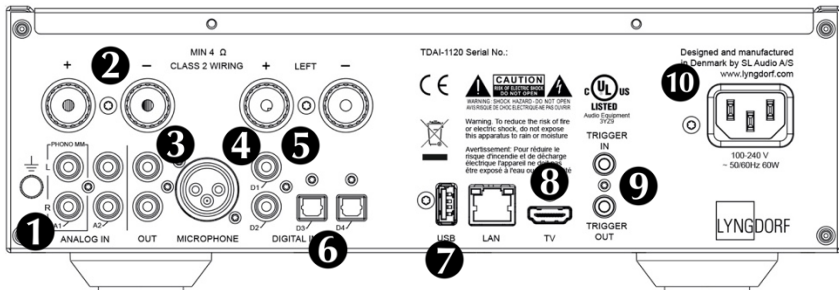

1. **A1/PHONO MM:** Connects directly to turntables/gramophones with high output cartridges (MM: Moving Magnet). The ground cable from the turntable/gramophone connects to the finger screw.
2. **A2/ANALOG IN:** Connects to tape recorders and other analog sources.
3. **OUT:** Analog connection to subwoofer(s), tape recorders, external amplifiers or headphone amplifier.
4. **MICROPHONE:** Connects to the microphone and microphone cable for RoomPerfect™ calibration.
5. **D1-D2 COAXIAL DIGITAL INPUTS:** Connects to CD players and other digital sources.
6. **D3-D4 OPTICAL DIGITAL INPUTS:** Connects to CD players and other digital sources.
7. **USB:** Connects to your FAT32 formatted USB storage (Pen Drive or Network Attached Storage, NAS).
This connector can also power the external storage drive or other devices.
8. **TV:** (No video output) Connects to your television's HDMI ARC connector for playing TV sound.
9. **TRIGGER IN/OUT:** These connectors allow you to have the TDAI-1120 activated by another product – or to have the TDAI-1120 activate other products, when turned on and off.
10. **MAINS POWER:** Always use a mains cable that fits your mains power outlet with ground connection. The TDAI-1120 will automatically adjust to the mains power available.

Front panel guide

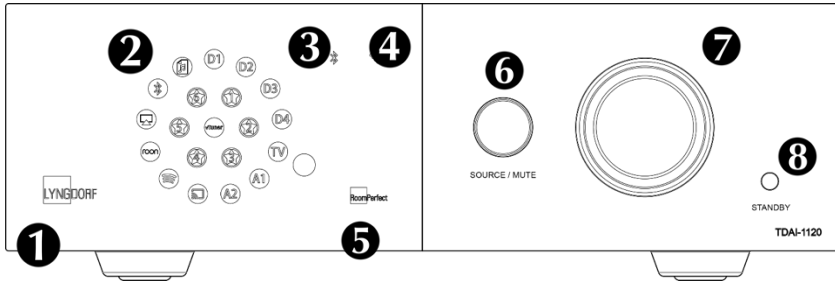

1. LYNGDORF logo

- Constant dimmed light = standby mode
- Constant bright light = power “ON” mode
- Flashing light = updating, starting mode, going in and out of deep sleep standby state (in all of these situations user operation is not possible)
- No light = power “OFF” mode

2. Display indicators for the selected input. All LEDs flash during factory reset.

3. Bluetooth indicator

- Constant light = connection with Bluetooth
- Flashing light = Bluetooth pairing mode
- No light = Bluetooth not connected

4. Wi-Fi indicator

- Constant light = connected to Wi-Fi
- No light = Wi-Fi turned off
- Flashing once per second = in Apple “WAC mode”
- Flashing multiple times per second = in “WPS mode”

5. RoomPerfect™ indicator

- Constant light = RoomPerfect™ guide has been executed, and RoomPerfect™ is calibrated
- Flashing light = RoomPerfect™ guide is currently running
- No light = no RoomPerfect™ processing is active

6. Source/Mute

- Short press to toggle mute and unmute
- Rotate left and right to toggle between audio inputs
- Press and hold for more than five seconds to initiate Wi-Fi setup using Apple WAC

- Press and hold for more than ten seconds to initiate Wi-Fi setup using WPS
7. Volume wheel
 - Adjust the volume with left or right rotation. Light indicator for volume setting.
 8. Standby button
 - Short press to turn the TDAI-1120 on or into standby mode
 - Press and hold for more than five seconds to initiate factory reset. If held for more than ten the procedure is aborted.

Note: See more about Wi-Fi setup in the section “Turning on the TDAI-1120 for the first time.”

How to get started

Before you connect the TDAI-1120 to mains power, you need to connect loudspeakers and other sources of audio. If you have a local network, connection by wire is recommended, as it provides a more stable and faster network connection than Wi-Fi.

The TDAI-1120 features a wide range of connectors on the back for external audio sources in addition to the streaming options available through Bluetooth or your network.

Connecting speakers

When connecting the speakers, always connect + and - from the amplifier to the corresponding + and - terminals on the speaker.

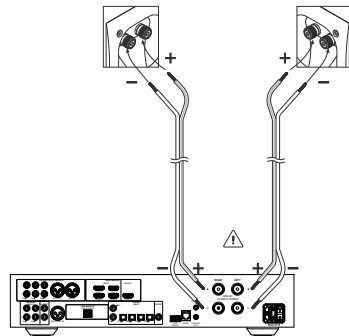

Tips for setting up speakers

You can use the stereo triangle as a good rule of thumb when determining where to place your speakers. The distance between the speakers should be the same as the distance from your listening position to both speakers.

If your room does not accommodate the optimal listening setup, the TDAI-1120 can compensate for this when you enter the actual distances to each speaker in the setup menu.

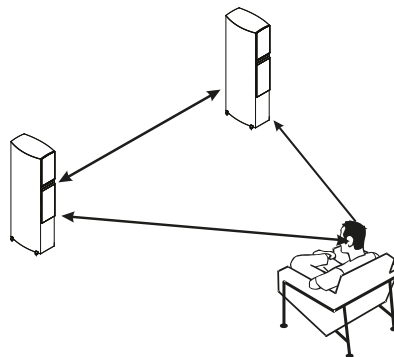

Speaker placement with RoomPerfect™

With a RoomPerfect™ calibration, you can place the speakers up against the wall without negative effects to the sound. If your speakers have a bass-reflex port on the back, you should allow for a 5cm/2in clearance to the wall. This will ensure there is no disruption to the functionality of the port.

With a single subwoofer, we recommend placing the subwoofer against the wall between the main speakers. With two subwoofers, you should position one in each front corner, in line with the main speakers.

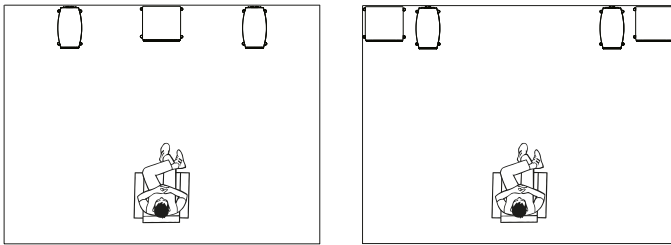

Connecting a subwoofer

The TDAI-1120 features a crossover function for optimal integration with any subwoofer.

When connecting to a Lyngdorf BW type subwoofer, you connect the analog output of the TDAI-1120 to the Bypass input of the subwoofer. In a traditional single subwoofer setup, connect the subwoofer to the left analog output on the TDAI-1120. For a stereo subwoofer setup, or if you have a subwoofer which has stereo input, use both left and right analog outputs.

Warning! Do not connect the TDAI-1120 to a subwoofer with High Level / speaker terminal inputs, as this will seriously damage the amplifier. Your subwoofers will not play until the setup has been finalized.

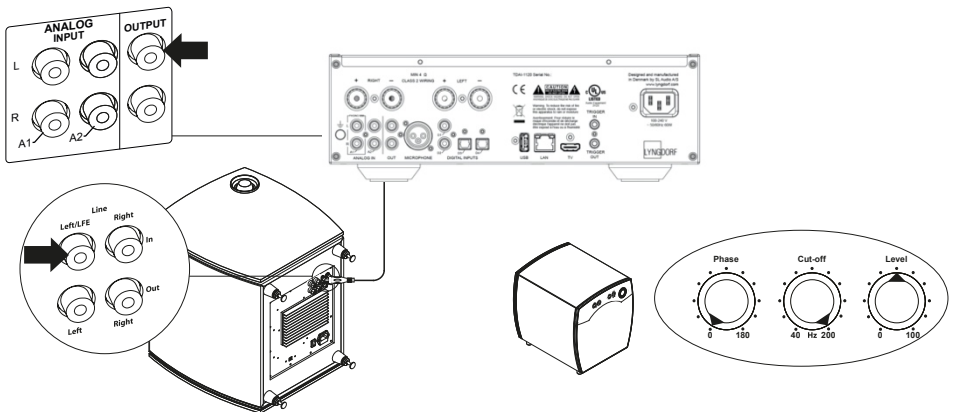

Subwoofer controls (not Lyngdorf type):

1. Phase adjustment should be 0° .
2. The subwoofer cut-off frequency should be set to the highest possible frequency range.
3. Level should be set to 50% of the maximum.

Turning on the TDAI-1120 for the first time

When you connect the TDAI-1120 to mains power, the Lyngdorf logo on the front will blink through-out the start-up process. When the logo stops blinking, push the Standby button and the TDAI-1120 is ready for operation.

Network connection by cable (recommended)

If the TDAI-1120 is connected to your network by cable, you can now access the TDAI-1120 by the Lyngdorf Remote Application for IOS and Android™ devices, and you can stream to the TDAI-1120 from your music applications. (See page 13, Lyngdorf Remote application.)

Establishing Wi-Fi connection

The TDAI-1120 can be connected to your Wi-Fi network through an iPhone/iPad functionality, an Android functionality or by using the manual WPS functionality on routers.

Holding SOURCE/MUTE button for 0-5 sec
Wi-Fi icon: on
Function: Reset

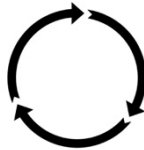

Holding SOURCE/MUTE button for 5-10 sec
Wi-Fi icon: flashing slowly
Function: smartphone/tablet procedure

Holding SOURCE/MUTE button for 10-15 sec
Wi-Fi icon: flashing quickly
Function: WPS select

Wi-Fi procedure with iPhone or iPad (active immediately upon turning on)

1. Press and hold the “Source/Mute” button for five seconds.
2. The Wi-Fi symbol will be flashing slowly, and the TDAI-1120 now appears on all your devices in the Wi-Fi section (under “Set new Airplay speaker”) under Settings.
3. Select the Airplay speaker and settings will be transferred from your smartphone/tablet to your TDAI-1120.

Wi-Fi procedure with Android

1. Open your Google Home App and press the add sign in the top left corner on the front page to start adding the TDAI-1120 to your “Google home” environment.

2. On the “Add and manage” page select “Set up device.”
3. On the “Set up” page select “Set up new devices.”
4. On the “Chose a home” select an already existing home or “Add another home.”
5. On the “Nearby devices” page select “Lyngdorf TDAI-1120.”
6. The “Help to improve Lyngdorf TDAI-1120” page is optional. You may select “No thanks” or “Yes I’m in.” Information sent to Lyngdorf is private and will be used only for improving the experience of the product.
7. On the “Add a custom room” page follow the custom guide or select one of the existing ones e.g. “Kitchen.”
8. On the “Lyngdorf TDAI-1120 found” page press “Yes” to start the actual setup of TDAI-1120.
9. The next page, “Connecting to Lyngdorf TDAI-1120” tells you that your phone or tablet may disconnect from Wi-Fi during setup. This is as expected as Google home connects to the TDAI-1120 to automatically transfer Wi-Fi settings of your phone/tablet to the TDAI-1120.
10. The next page should read “Did you hear the sound?” If your device went to sleep at this point, you may have missed this. In that case just press “retry.” Press “Yes” when you hear the sound to continue.
11. On the “Connect to Wi-Fi” page select the Wi-Fi that your TDAI-1120 should connect to, preferably one located close to the device that uses 5GHz technology. The “Connecting to Wi-Fi” and “Connected” pages will be shown.
12. The next page, “Linking your Lyngdorf TDAI-1120,” gives you the ability to link your TDAI- 1120 to a Google account to make use of the many Google features. Read the “Before using your Goggle Assistant,” “All done!” and “Speaker is ready” pages.

Note! For setting up Google Home on an iPhone/iPad, follow the steps above (points 12 will be skipped).

Manual Wi-Fi procedure (WPS)

If you don’t have a smartphone or tablet, you can connect to Wi-Fi through the manual procedure, WPS mode.

1. Press and hold the SOURCE/MUTE button.
2. After ten seconds the Wi-Fi symbol will be flashing quickly. Release the Source/Mute button, and the TDAI-1120 will search for a WPS connection (this can take up to 15 minutes).

3. Press the WPS button on your Wi-Fi router, and the TDAI-1120 will start connecting.
4. When the Wi-Fi icon stops flashing, the TDAI-1120 is connected.

Factory reset

If you press and hold the Standby button for more than five seconds all the icons will be showing and then you should release the button. The TDAI-1120 will initiate a factory reset. The factory reset will clear all your previous settings, Wi-Fi settings, saved playlists etc.

If you have pressed the Standby button for more than five seconds by mistake, you can avoid the factory reset by holding the Standby button for an additional five seconds. This will skip the factory reset initiation.

How to use the TDAI-1120

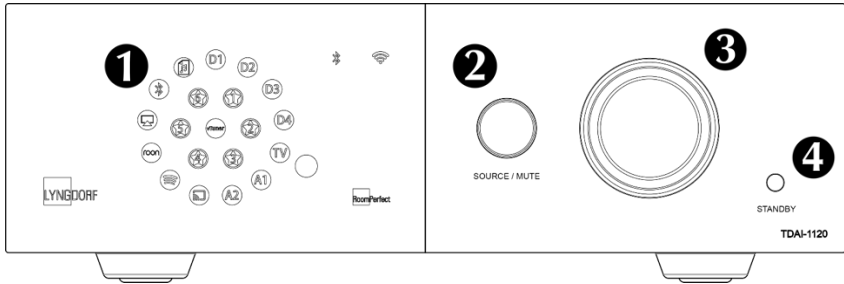

Turn on the TDAI-1120 by pressing the Standby button **4**

Turn the Source button to select the music source **2**

– when streaming audio to the TDAI-1120, it will automatically switch to the correct input

– see which source is active on the Display. **1**

Press the same button to Mute the sound temporarily – un-Mute by pressing the same button. **2**

Turn volume up and down on the volume knob.

The light relates to the position of the volume knob **3** – red light is not necessarily a problem, if the source volume level is low. When the music sounds harsh and distorted, your speakers can be damaged. You cannot damage the amplifier by turning the volume up.

Lyngdorf Remote app

For Android and IOS based phones you will be able to download the “Lyngdorf Remote” app, which will allow you to handle the operation of your TDAI-1120 – see examples.

Select input, listening position and voicing directly, and see the signal information in the volume wheel, which you can operate like you operate the volume on the amplifier itself. When using the internal media player album information will appear, when available.

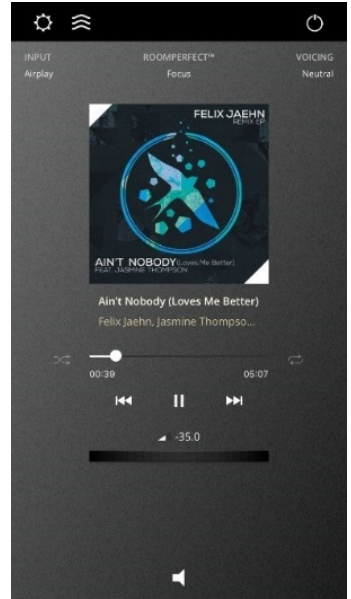

The top left icon will access the connection settings for selecting the Lyngdorf product to be controlled, and open the web interface for accessing the setup.

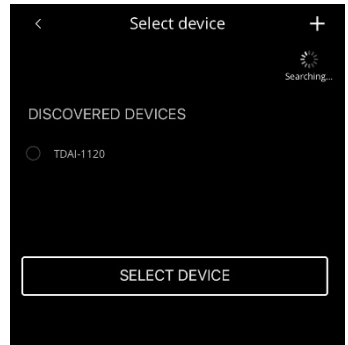

Under General Settings you can select the use of large album art, which then will replace the volume wheel in the interface. Volume can still be controlled using the volume control of the device.

If you are using your device as media player, you can choose to block your device from closing when the Remote App is active.

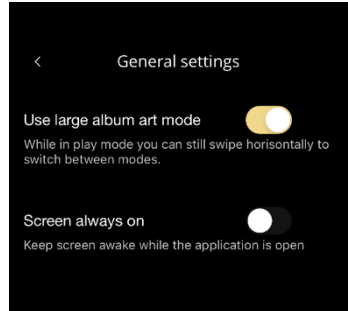

The next icon will open the interface for streaming music and the top right icon will turn the amplifier on or off.

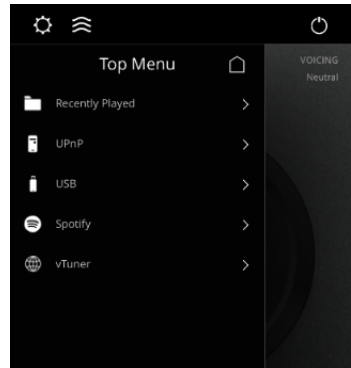

Using the vTuner menu will allow you to play all radio stations available on the internet

Note that through the website you can save up to five stations as pre-sets, which then are directly available from the input selector on the front or through the Lyngdorf Remote application.

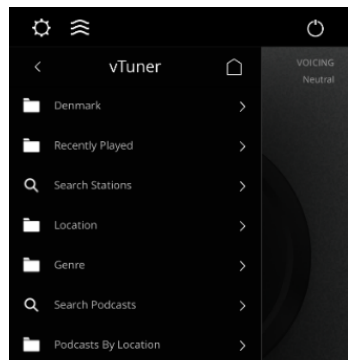

TDAI-1120 setup page

When the TDAI-1120 is connected to your local network, you can connect to your TDAI-1120 in different ways. Use the Lyngdorf Remote app to discover the device and enter the homepage. In the setup menu, you will be able to find the network device address and a direct link to the setup page on your internet browser. If you do not want to install the Lyngdorf Remote app, you can type the following in a browser on any device on your network:

tdai1120.local.

Finalizing the setup

Now you can start enjoying music, but we recommend that you adjust the settings and do a RoomPerfect™ calibration to enjoy everything the TDAI-1120 can offer.

Open the web-page of the TDAI-1120 as described earlier, and we will introduce you to the available menus:

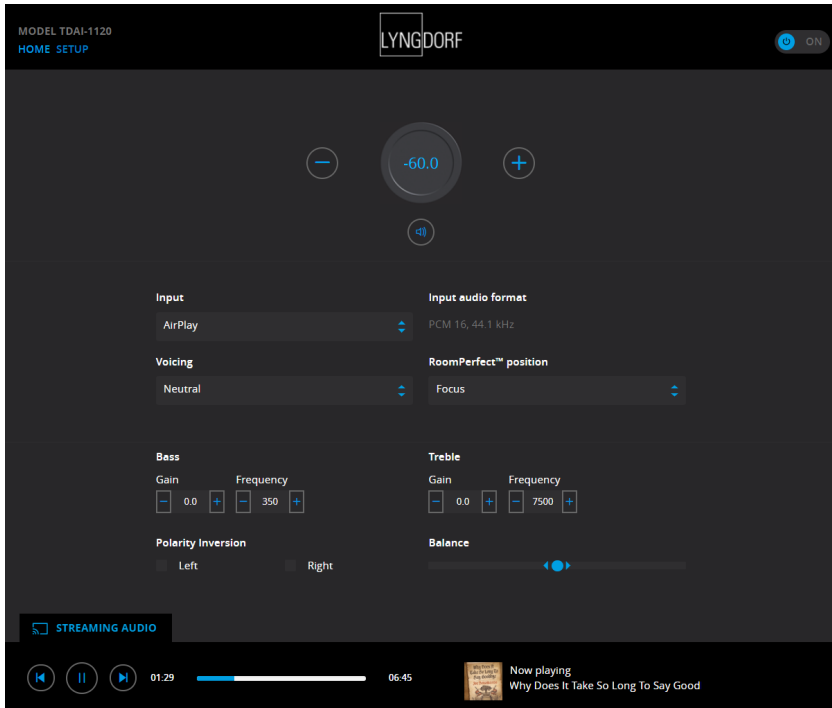

The Home screen refers to the daily operation as performed with the remote control. The page displays selected input and formats and you can control the volume setting

The Setup section will be described in the following pages.

You can control the volume level with the volume wheel, and the button below will mute/unmute the sound.

You can change inputs, voicings and RoomPerfect™ position (individually calibrated positions for optimal performance). You will be able to see the type and quality of the audio signal received.

The lower section is dedicated to the adjustment of sound, Balance, Bass and Treble. These work as traditional controls. For Bass and Treble you can not only adjust the levels but can also change the frequencies that must be attenuated or enhanced.

Polarity inversion is equal to changing + and – on the cables to the loudspeakers. You can do this individually for each speaker.

The Streaming Audio interface for controlling the built-in media streamer is found in the bottom section of this page. For information on the use of the interface see section for Streaming Setup.

Hot tip: On your mobile device the Home Screen page of your amplifier can be saved as an icon for swift access to operation of the TDAI-1120.

Setup menu

Input setup

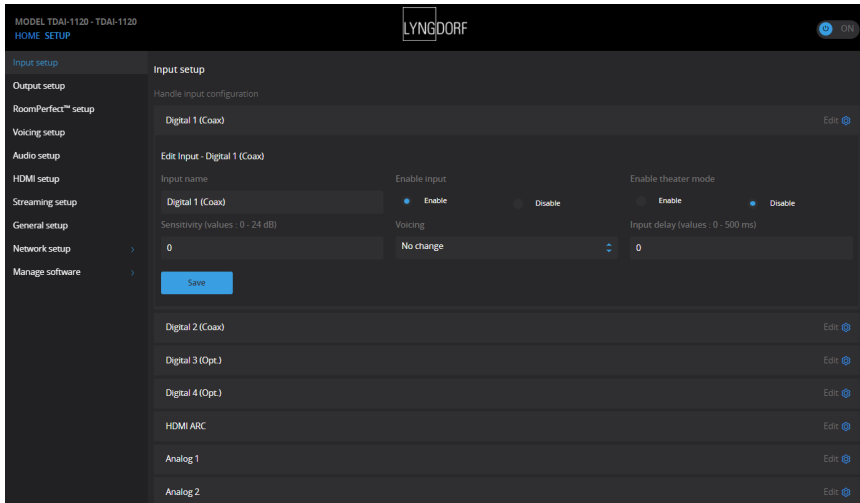

Input name:
Changes the name of the selected input.

Note: To remove all text after the blinking marker, press and hold the “Down” button.

Sensitivity:
Enables you to match input levels from different sources. Can be adjusted up to +24dB.

Voicing:
Selects a default voicing for the input which is active when in this menu. If you always want extra bass on your gaming console audio, for example, set that voicing here.

Enable theater mode:
Turns the amplifier into a dedicated power amplifier for the input which is active when in this menu.

Warning: This feature bypasses the volume control!

Do not test this setting with a CD player or similar unregulated signal!

This feature might be selected if you are using the TDAI-1120 in a home theater setup where it is used to power and calibrate the front speakers and/or subwoofer. Connect your home theater processor to the selected input.

When selecting other inputs, the amplifier returns to the last current volume.

Input delay:

If the connection of a display has introduced asynchronous playback of audio and video, you can select a delay time to ensure that the video and audio signals are played back simultaneously.

Output setup

The standard setup is with a traditional pair of loudspeakers. If you want to add subwoofer(s) or in any way adjust the setup, you will learn in this section how to set up your system before performing the RoomPerfect™ calibration. There is a selection of output settings to choose from, which allow for loading dedicated filters to optimize the performance of Lyngdorf speakers and boundary woofers. Custom Sub will open for your use of any subwoofer design – Advanced will open ALL settings.

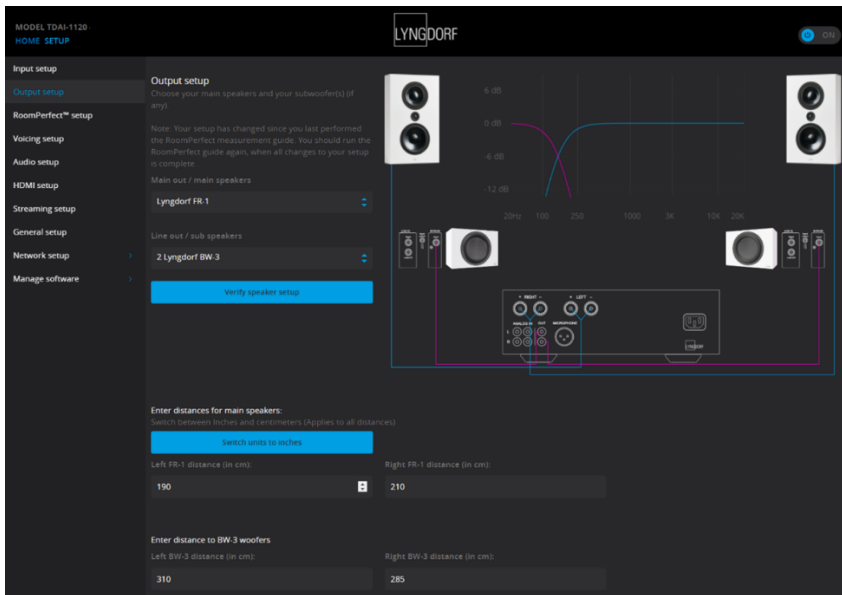

Note: If you change anything in the output settings of the speakers and subwoofers, you must do a new RoomPerfect™ calibration.

If you have a perfect speaker setup with two speakers, you do not need to enter anything under distances.

Delays:

When integrating subwoofer(s) with speakers, you need to adjust for differences in phase so that the two parts of the signal (from speaker and subwoofer) arrive to your ear at the same time. This is more effectively achieved digitally than by trying to find the correct settings on the subwoofer(s). The TDAI-1120 will adjust for phase based upon your entry of the distances between the speakers' and subwoofers' locations in relation to your listening position (focus position).

Measuring distances

Splitting the sound into speakers and subwoofer(s) requires that the outputs be adjusted in time (phase), so that the two parts of the sound arrive to your ear at the same time. This is achieved by measuring the actual distances to your speakers and subwoofer(s). Through the differences in distances the TDAI-1120 can calculate the delay which need to be added to each output. This data must be entered in the Setup Menu.

When measuring the distance to your speakers, measure from the preferred listening position (the focus position) to the front of the speakers. When measuring the distance to a subwoofer, measure from the preferred listening position to the back corner of the subwoofer.

Speakers

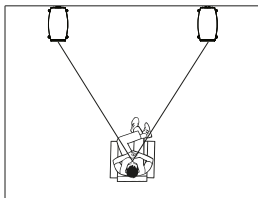

Subwoofers

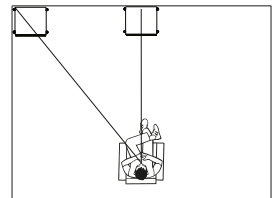

Using other manufacturers' subwoofers requires a few more entries:

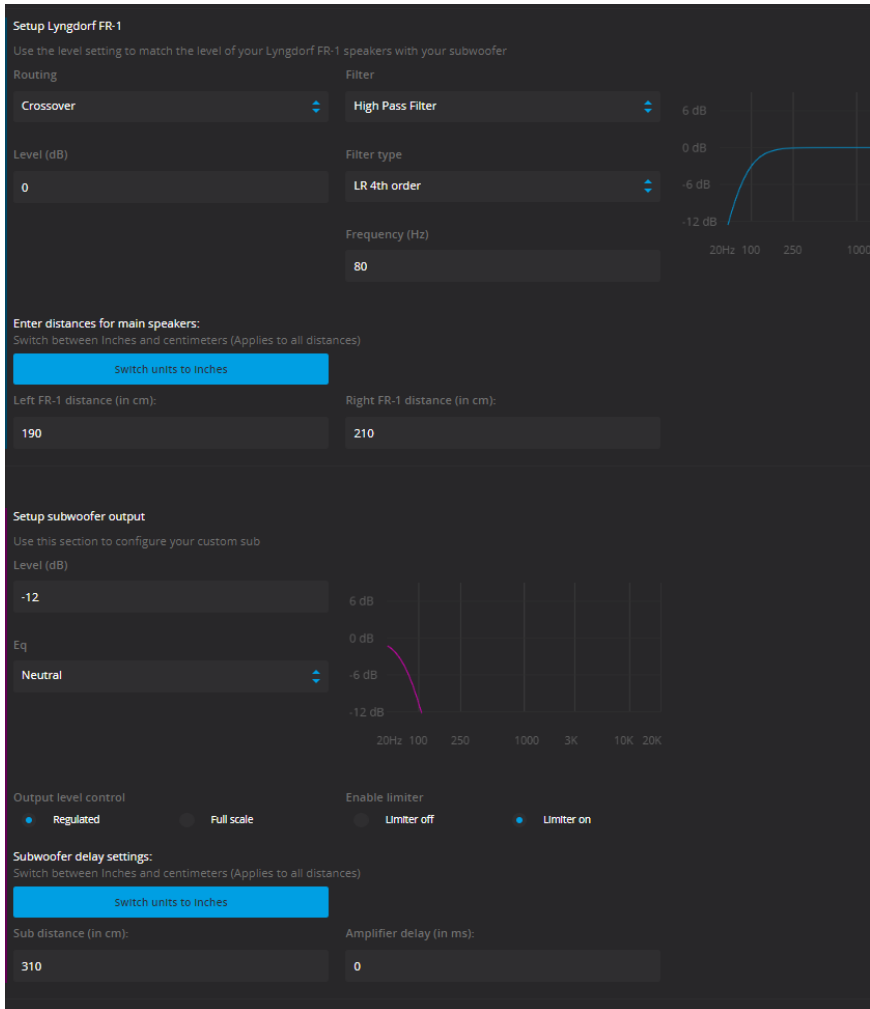

Amplifier delay:

On analog and digital out, you can set an amplifier delay. If you have an active subwoofer with internal signal processing (DSP) or a separate amplifier, there may be a natural electronic delay in these products.

Refer to the original manufacturer's instructions to obtain the correct amplifier delay in milli-seconds and enter this data. The TDAI-1120 will delay the signal to the speakers to match the delay entered.

Main speaker output:

- The available settings are:
 - Crossover
 - High pass removes the frequencies below the crossover frequency.
 - Low pass removes the frequencies above the crossover frequency.
 - Full range allows the signal to pass unfiltered.

Analog output:

The available settings for routing are:

- Crossover
 - High pass removes the frequencies below the crossover frequency.
 - Low pass removes the frequencies above the crossover frequency.
- Full range allows the signal to pass unfiltered to a separate amplifier, bypassing the internal amplifier.
- Tape Out disables RoomPerfect™, voicings and volume control.
- Off mutes the output.

Level adjusts the output to align the level of the subwoofer(s) to the level of your main speakers. Making the output adjustment here is far better than attenuating the level on the subwoofer itself.

Low or High pass crossover filters:

If a filter is selected, the frequencies below or above the selected crossover frequency will be directed through the designated output terminals.

The available types of crossover filters are named after the inventors of these filter designs:

LR: (Linkwitz Riley) 2nd, 4th or 8th order.

BW: (Butterworth) 1st, 2nd or 4th order.

Generally, we recommend starting with a 4th order Linkwitz Riley filter, which is selected when you activate the output by choosing one or two Custom subwoofers.

Frequency sets the position of the crossover between loudspeakers and subwoofer(s). Our recommendations are loaded when you activate the analog output.

Output Level Control (Volume) has the following options:

- Regulated makes the output level follow the level of the volume control.
- Full scale means there is a constant output at maximum level.

Warning: If full scale is selected, you will have full volume output, and this can overload and damage speakers.

Enable Limiter will make sure that no matter how loud you are playing, the output signal will be noiseless and safe for your connected equipment.

Selecting Advanced setup for an output will allow you to tweak the settings to each output.

Under EQ you can now select Custom to design your own Pre-Equalizer, which will allow you to add a filter to this output to optimize the performance. RoomPerfect™ will calibrate against the performance with this filter engaged.

Selecting Advanced setup for an output will allow you to tweak the settings to this output. Under EQ you can now select Custom to design your own Pre-Equalizer for optimizing the performance of your setup. RoomPerfect™ will calibrate against the performance with this filter engaged.

Verify Speakers is a function to test your system connections. A tone will be sent to each speaker and subwoofer. When you have verified that the connection is correct, press Next and go through all outputs.

RoomPerfect™ setup

RoomPerfect™ is designed to analyze and correct for the negative effects that the listening room has on the speaker sound. When a calibration is being performed, the RoomPerfect™ Icon will be blink.

RoomPerfect™ guide

This will start the guided RoomPerfect™ setup and will erase previously stored calibrations. When completed, the following menu items are available in the RoomPerfect™ setup menu.

The RoomKnowledge index is an estimate of how much of the room's acoustical properties have been learned from the room measurements. The higher the RoomKnowledge index, the greater the accuracy of the calibration.

Hot Tip: The objective is to have the RoomKnowledge index increase as slowly as possible. This indicates that each measurement holds new data for the calibration. When the measurement does not give new data, the index will increase quickly.

Handle focus positions

If you would like to add an additional focus position, the chair next to the couch perhaps, it can be done here. It is possible to have up to eight different focus positions.

The saved calibration volume from the RoomPerfect™ guided setup is used as a default when adding extra focus positions. The volume can be changed at any time between measurements to suit a situation. This will not affect the quality of the measurement or the result.

Add room measurement

It is possible to add more room measurements, which can increase RoomKnowledge and thereby fine tune all the room correction filters.

Placing the microphone in the focus position

When you are prompted to place the microphone in the focus position, connect the microphone to the microphone input on the back panel using the provided microphone cable and place the microphone, using the microphone stand, in your primary listening position. The height and the orientation of the microphone should correspond to your head's height and direction.

Press enter and a test signal will start from the left speaker. The TDAI-1120 will give an estimated optimal volume for calibrating the system or will accept the current volume. Adjust the volume if required and retry the measurement.

The calibration volume should not be so loud that it is inconvenient to you, or that it causes damage to your loudspeakers. If this is the case, set it to a lower and more appropriate level. A low volume can result in a longer calibration time or a measurement time out. If the system accepts a measurement, you can go on. A low volume and long measurement will not affect the quality of the calibration.

Measuring the focus position

When the calibration volume has been set, RoomPerfect™ will send a range of tones to measure the focus position.

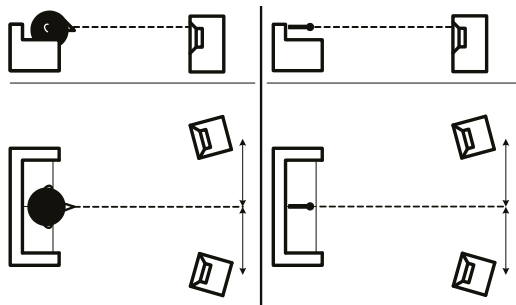

Measuring random room positions

When the focus position has been measured, the next step is to measure the acoustical properties of the room. It is important to perform well spaced measurements to get a comprehensive image of the acoustical properties of the room. See “RoomPerfect troubleshooting” on page 24 if the measurement stops prematurely.

Keep taking measurements until RoomKnowledge reaches minimum 90%.

These are the rules of thumb when measuring the room:

- The microphone must always have a clear line of sight to the tweeter mid-range of the speaker.
- The microphone should be in random and varying positions and orientations. Point it up/down/sideways, the more random positions the better. The height of the microphone should be between ear-height seated and standing.
- The measurements should cover the entire listening room, but not open hallways and kitchens.
- The microphone should not be closer than 0.5m/1.5ft from the floor, ceiling, and walls.
- The microphone should be at least 1m/3ft from the front of the loudspeakers.
- Do not take symmetrical measurements in the room.

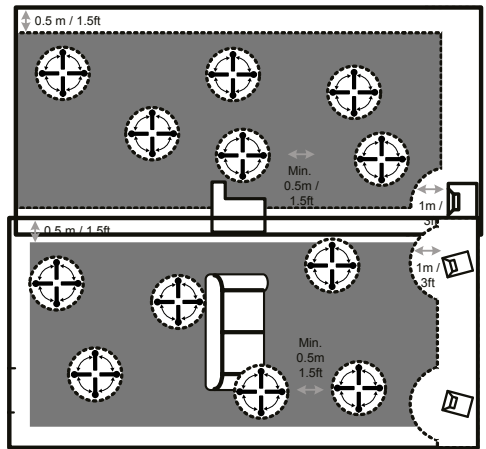

Room measurements above 90% RoomKnowledge

Note that RoomKnowledge is calculated by the computer based on how much of the new measurement it already knows. If the RoomKnowledge index does not increase after a measurement, you have added a good measurement with a lot of new information.

To fully optimize RoomPerfect™'s understanding of the room's acoustical properties, we recommend you keep doing measurements until RoomKnowledge is above 95%. The higher the RoomKnowledge, the more accurate the room correction filters will be.

When room measurements are complete, the TDAI-1120 will calculate the focus and global filters automatically.

RoomPerfect™ troubleshooting

The calibration microphone is very sensitive and may pick up unwanted noise, including subsonic signals and background noise, which disturb the

measurements. If the signal is disturbed it will take longer for the system to make a correct measurement.

A measurement that has been disturbed by noise but completed will always be correct; it is not necessary to redo it. If the measurement has stopped due to an error, one of the following error messages will be shown.

Signal error! Check microphone and cable, then press Enter.

No microphone is connected, or the microphone cable is defective. Check that the microphone cable is connected to the microphone socket on the back panel. If the problem continues, test the microphone cable by connecting the microphone directly to the microphone socket and select Retry.

If the microphone is detected, replace the microphone cable and retry the measurement.

Error: Signal clipping - or - Error: Too much noise

Either the incoming signal has been classified as too loud, resulting in clipping or distortion, or a loud noise in the immediate environment has corrupted the measurement results. If a loud noise has in fact occurred, such as the sound of a closing door, reduce noise levels inside and in the immediate vicinity of the room and repeat the measurement. If no loud noise has occurred, reduce the volume of the signal and repeat the measurement.

Error: Signal too low

This error message is displayed when the measurement has lasted more than five minutes for the low-frequency signal or more than two minutes for the high-frequency signal. This happens most often when using a low-level measuring signal compared to the background noise in the listening environment, which results in prolonged measuring times. Raise the measuring signal volume or reduce the noise in the environment before continuing with the measurement.

Voicing setup

Enables and disables voicings to enable quicker selection of your preferred equalization. Warmer sound, more bass – everything is available. See separate manual for designing your own Voicings.

Audio setup

This section allows you to activate the following settings:

Enable ICC will ensure that a digital signal is not distorted due to high level (modern music most often suffers from high compression and too high levels to improve the appeal when played on the radio.

Show RoomPerfect™ bypass will allow you to test and demonstrate the effect of the calibration.

Enable Subsonic filter will cut all signal below the audible frequencies. If you are using a turntable, you need to have this filter activated in order to not transmit vibrations to the pick-up cartridge.

Main volume control will allow you to set the default volume when turning on the TDAI-1120, as well as to set a maximum limit to how loud the TDAI-1120 may play.

HDMI setup

HDMI (High-Definition Multimedia Interface) is a standard for transmission of video and audio from source to playback device. The connection exchanges information as to available types of data against what the playback devices will accept.

CEC (Consumer Electronics Control) is an HDMI feature designed to allow commands to be sent from one product to another – as examples: allowing the player to turn on the television or to control the volume setting of the TDAI-1120 by using the remote control of the TV.

In all setups the level of CEC implementation on the television sets the limits of the possible integration. Functions may be reduced to support your own products and may not include full support of CEC codes.

Enable CEC will activate the function and allow your TV to connect to the TDAI-1120.

Note: You need to set Standby level(General Setup) to Network standby for CEC to function. As default, CEC is not active on HDMI to comply with regulations requiring a very low standby power. Turning it on will raise standby power to 1.2W

CEC power will allow for the TDAI-1120 to automatically switch on from standby, when the television or HDMI connected source is turned on.

CEC audio system allows for the television to be used as speakers for sources connected to the TDAI-1120.

Note: Menus only appear if CEC is enabled.

Streaming setup

The TDAI-1120 supports a variety of media streaming services.

Device name will allow you to re-name each individual TDAI-1120, which can be very useful in multi-room setups.

Streaming player options will allow you to control how applications on mobile devices can interact with the TDAI-1120. These options control the volume setting, change inputs and turn the unit on.

Chromecast built-in™

Chromecast built-in is a platform that lets you stream your favorite music from your phone, tablet or laptop right to your speakers. Easily control your speakers with apps you already know and love from your iPhone®, iPad®, Android phone or tablet, Mac® or Windows® laptop, or Chromebook

Please use your Google Home application to accept Google Terms of Service and Google Privacy Policy

<https://policies.google.com/privacy?hl=en>.

Spotify Connect

Use your phone, tablet or computer as a remote control for Spotify.

When the TDAI-1120 is connected to your local network, it will be available from your Spotify Connect enabled devices. Go to spotify.com/connect to learn how (requires a Spotify account).

The Spotify Software is subject to third party licenses found here: www.spotify.com/connect/third-party-licenses.

Roon

Use your Roon control app to initiate streaming. To read more about Roon services go to <https://roonlabs.com>.

Airplay2

The TDAI-1120 has native support for multi-room application under Apple Airplay. Use your iOS device to initiate individual or simultaneous Airplay streaming to all TDAI-1120 amplifiers in your setup.

<https://www.apple.com/airplay/>

Bluetooth

The TDAI-1120 supports Bluetooth streaming mode. To enable pairing, turn Source wheel until Bluetooth is selected. If no device is presently connected, pairing mode will start and the LED will be flashing.

UPnP

The TDAI-1120 also supports Universal Plug and Play. This gives apps the ability to stream audio from a UPnP server to the TDAI-1120.

USB

If a USB memory stick with audio files is mounted to the TDAI-1120, you can play songs from this storage using the web page “Streaming Audio” tab or in the Lyngdorf Remote app for Android and iOS as part of “Top Menu.” The USB stick must be formatted as FAT32 file system.

vTuner

Play vTuner radio channels or podcasts from vTuner service. This can be initiated from the web page “Streaming Audio” tab, or in the Lyngdorf Remote App for Android and iOS as part of “Top Menu.”

Presets

vTuner stations and Spotify albums can be stored as presets 1-10. This can be done on the web page in “Streaming Audio” tab. When a preset is saved, it will be selectable as an input either from the front panel, web page, Lyngdorf Remote app or by remote control. A preset can be stored by pressing a numeric key (1-6) on the remote control until that particular preset selection is visible on front panel.

Tidal Connect

When the TDAI-1120 is connected to your local network, it will automatically be available from your Tidal Connect enabled devices in the Tidal app. (Requires a Tidal account)

MQA

Playing MQA files

The TDAI-1120 includes MQA Core Decoder, which unfolds the MQA file once to deliver better than CD-quality. The first unfold recovers all the direct music-related information.

MQA (Master Quality Authenticated) is an award-winning British technology that delivers the sound of the original master recording. The master MQA file is fully authenticated and is small enough to stream or download.

MQA files can be played from USB, TIDAL, UPnP and Roon.

In the Streaming Player MQA will be indicated by the MQA logo, for example when using Tidal Connect:

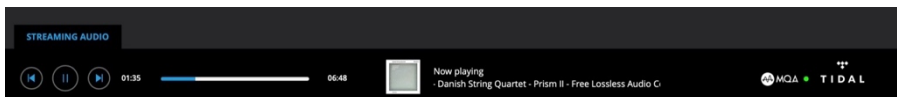

General setup

Power Management determines the stand-by setting of the TDAI-1120: Deep Sleep (default) uses the lowest possible power consumption. Network Standby will keep the TDAI-1120 alert, and it will react to commands over the networks.

Auto off delay sets the idle time required for automatic shut-down of the amplifier.

Trigger input function can be used to activate and deactivate the TDAI-1120 through connection with a DC trigger signal from another device. If you set it to a specific input, this input will be selected automatically upon receiving a signal. Amp. Power Mode will start the TDAI-1120 on the input last used.

Note: If the TDAI-1120 has been switched to another input, the trigger command from the source connected will not turn off the amplifier!

Remote control (optional accessory):

Disable the infrared remote control function, if the commands from other equipment's remote controls are affecting the TDAI-1120.

Display settings will allow you to reduce the brightness level of the display. You can activate a time-out, which will turn off the display with a little delay after each operation.

Manage software

Backup

When a USB device is inserted in the connector on the rear of the TDAI-1120, this menu will allow you to store a complete backup of settings and the RoomPerfect™ calibration. This will allow you to restore the amplifier to this specific setup at a later date.

Restore

If a backup file is available on USB, you can select and load it.

Factory reset:

Restores the system to the default factory settings.

Warning: All user preference settings, system data, and RoomPerfect™ data are lost when restoring to default settings!

Download system log

This function will save a file on your PC/MAC. This file can be essential for identifying a fault on your amplifier.

Update software

In this menu you will see the software version loaded on the TDAI-1120. Refer to www.lyngdorf.com for the latest software.

To update the TDAI-1120:

On the web interface you can select a new software and directly update the TDAI-1120 from the software server on the internet.

If the TDAI-1120 is not connected to the internet, you can update the software by saving the software file on a FAT32 formatted USB drive- Through the web interface, select the software from the USB drive.

In case the web interface is not accessible, or a fault in the update process has made the amplifier inaccessible, you can force a new software onto the TDAI-1120:

1. Save the new software on a FAT formatted USB drive.
2. Insert the USB drive into the “SW Update” connector on the back of the TDAI-1120.
3. Turn off the TDAI-1120 by disconnecting the mains power.
4. Hold down the standby button on the front and connect the mains power again.

5. When the Lyngdorf logo starts flashing, release the standby button and the TDAI-1120 will update the software. When the update is finished, the amplifier goes into standby.

Cleaning and maintenance

The TDAI-1120 does not require any regular maintenance except to keep its exterior clean. Simply wipe it with a clean, soft cloth. A small amount of non-abrasive cleaner may be used on the cloth to remove any dirt or fingerprints. Do not use abrasive cleaners or cleaners containing liquid solvents.

Control Manual

To get a copy of the Control Manual, which describes how to operate the device from other control systems, download it from www.steinwaylyngdorf.com, or contact your local Lyngdorf Audio representative.

Technical assistance

For the latest version of this manual, please check the Lyngdorf Audio website: www.steinwaylyngdorf.com.

If you have any problems with or questions regarding your Lyngdorf Audio product, please contact your nearest Lyngdorf Audio dealer.

Enjoy!

SL Audio A/S
Ulvevej 28
7800 Skive
Denmark

E-mail: contact@lyngdorf.com
Web: www.steinwaylyngdorf.com