

JBL

S Y N T H E S I S[®]

SDP-75

3D SURROUND PROCESSOR
USER MANUAL

v. 4.1

SDP-75 USER GUIDE

Software version v4.0

Last update: August 2, 2017

NOTICES

LIABILITY

The legal guarantees of conformity and latent defects under no circumstances cover any damage arising from accidents, misuse or an assembly error, negligence or considerable modification of the appearance or functioning of the returned equipment.

JBL Synthesis reserves the right to refuse any guaranteed return for a damaged product on account of misuse.

I. Acknowledgments

DTS® is a registered trademark of DTS, Inc.

Dolby® is a registered trademark of Dolby Laboratories.

Auro-3D® is a registered trademark of Auro Technologies.

All other trademarks are the properties of their respective owners.

The SDP-75 is manufactured under license from Dolby Laboratories. "Dolby", "Dolby TrueHD", "Dolby Atmos" and the Double-D symbol are registered trademarks of Dolby Laboratories. License Notice and Trademark Acknowledgment Required for Licensed Products Manufactured under license from Dolby Laboratories. Dolby, Dolby Atmos, Dolby Surround, and the Double-D symbol are trademarks of Dolby Laboratories.

For DTS patents, see <http://patents.dts.com>. Manufactured under license from DTS Licensing Limited. DTS, the Symbol, DTS in combination with the Symbol, DTS:X, and the DTS:X logo are registered trademarks or trademarks of DTS, Inc. in the United States and/or other countries. © DTS, Inc. All Rights Reserved.

The SDP-75 is manufactured under license from Auro Technologies. BL Synthesis is certified by Auro Technologies to implement its technology and products. Auro-3D® and the related symbols are registered trademarks of Auro Technologies. All materials contained in this work are protected by copyright law and may not be reproduced, distributed, transmitted, displayed, published or broadcast without the prior written permission of Auro Technologies NV or in case of third party materials, the owner of that content. You may not alter or remove any trademark, copyright or other notice from copies of the content.

©2003-2016 JBL Synthesis. All rights reserved.

Due to constant improvement, all products specifications and design may change without notice.

Photos and illustrations are non-contractual.

IMPORTANT SAFETY INSTRUCTIONS

- Read the following instructions carefully. Save all instructions for future reference.
- Follow all warnings and instructions.
- JBL Synthesis expressly forbids unauthorized modification of this equipment.
- Using the unit in the following locations can result in a malfunction:
 - In direct sunlight
 - Locations of extreme temperature or humidity
 - Excessively dusty or dirty locations
 - Locations of excessive vibration
 - Close to magnetic fields
- Condensation can form on the inside of the apparatus if it is suddenly moved from a cold environment to a warmer location. Before switching the unit on, it is recommended that the unit be allowed to reach room temperature.
- Install the SDP-75 on a solid, flat, level surface that is dry, well ventilated and out of direct sunlight. Be sure that all four feet are supported.
- • Clean only with a dry cloth. Do not use liquid solvent-based cleaners.
- Protect the detachable power cord from being walked on or pinched particularly at plugs, convenience receptacles, and the point where they exit from the apparatus. If the ac cord becomes damaged, do not use it. Immediately replace it with a new one of the same or better rating.
- Unplug this apparatus during lightning storms or when unused for long periods of time.
- Do not open the equipment case or remove any of the cover panels. There are no user serviceable parts in this equipment. Refer all servicing to qualified service personnel;
- To prevent fire or shock hazard, do not allow liquids to spill or objects to fall into any openings of the product.
- Always insert the ac plug into a grounded outlet. Do not remove the ground pin or disable the ground for any purpose. The main AC has to be protected by a circuit breaker conforming to local standards.
- Before connecting the equipment, check that the main power supply voltage rating corresponds with the local main power supply. The rating of the main power supply voltage is printed on the equipment.
- If replacement of the ac line fuse and/or any internal fuse becomes necessary, replace only with same value and type of fuse (110V: T1A Schurter FST 5x20; 220V: T800mA Schurter FST 5x20). Never bypass the fuse.
- It is imperative that the SDP-75 be operated in a well ventilated environment and the immediate external temperature be maintained as specified. Do not expose the SDP-75 to humidity, steam, smoke or excessive dampness or dust. Maximum permissible operating conditions: 0°C to 40°C, 20-65% relative humidity. External cooling fans may be required in some cases.
- Do not stack any equipment directly above or below the SDP-75 as to protect it from overheating, as well as the continued functionality of any equipment near and around it.
- Do not ingest the remote control battery. The remote control supplied with this product contains a coin battery. If the button cell battery is swallowed, it can cause severe internal burns in just 2 hours and can lead to death. Keep new and used batteries away from children. If the battery compartment does not close securely, stop using the product and keep it away from children. If you think batteries might have been swallowed or placed inside any part of the body, seek immediate medical attention.

TO COMPLETELY DISCONNECT THIS APPARATUS FROM THE AC MAINS, DISCONNECT THE POWER SUPPLY CORD PLUG FROM THE AC RECEPTACLE.



THIS SYMBOL IS INTENDED TO ALERT THE USER TO THE PRESENCE OF UNINSULATED "DANGEROUS VOLTAGE" WITHIN THE PRODUCT'S ENCLOSURE THAT MAY BE SUFFICIENT MAGNITUDE TO CONSTITUTE A RISK OF ELECTRIC SHOCK.

TABLE OF CONTENTS

NOTICES	4
IMPORTANT SAFETY INSTRUCTIONS	5
TABLE OF CONTENTS	6
1 INTRODUCTION	10
1.1 ABOUT THIS GUIDE	11
1.2 PRODUCT INFORMATION	13
1.3 SYSTEM INTEGRATION	14
1.4 JBL SYNTHESIS CERTIFIED INSTALLERS	14
1.5 UNPACKING THE SDP-75	15
1.6 THE HARDWARE	16
1.6.1 Front panel layout	16
1.6.2 Front panel display	16
1.6.3 Rear panel layout	17
1.6.4 IR remote control	18
1.7 THE SOFTWARE	19
1.7.1 Available options to access the graphical user interface	19
1.7.2 Important note about the web-based interface	20
1.7.3 Using a display, mouse and keyboard connected to the SDP-75	20
1.7.4 The Top menu bar	21
1.7.5 The Main user interface	22
1.7.6 The Lateral menu bar	22
1.7.7 Folded lateral menu	23
1.7.8 Unfolded lateral menu	24
1.7.9 The Speakers/Room setup tool	25
1.7.10 The Fine Tuning panel	25
1.7.11 The Advanced Settings interface	26
1.7.12 Product Information	26
1.7.13 Software updates	27
2 NETWORK SETUP	28
2.1 CHOOSING A NETWORK CONFIGURATION	28
2.2 CONNECTING TO THE SDP-75	29
2.2.1 Overview of the network connection procedure	29
2.2.2 Step 1: download and install a VNC client on your device	30
2.2.3 Step 2: put the SDP-75 and your device on the same network	31
2.2.4 Step 3: connect to the SDP-75 from your device	35
2.2.5 Using a Mac OS X computer with Screen Sharing	36
2.2.6 Using a Mac OS X computer with Chicken of the VNC	37
2.2.7 Using a Windows computer with Tight VNC	38
2.3 CHANGING THE NETWORK SETTINGS THROUGH THE FRONT PANEL	41
2.3.1 Checking the Wi-Fi settings	41
2.3.2 Checking the Ethernet settings	42
2.3.3 Connecting the SDP-75 to a Wi-Fi network	42
2.4 CHANGING THE WI-FI SETTINGS THROUGH THE GUI	43
2.4.1 About the Wi-Fi information	43
2.4.2 Checking the Wi-Fi settings	43
2.4.3 Connecting the SDP-75 to a Wi-Fi network	44
2.4.4 Changing the Wi-Fi Status mode of the SDP-75	45
2.5 CHANGING THE ETHERNET SETTINGS THROUGH THE GUI	46
2.5.1 About the Ethernet information	46
2.5.2 Checking the Ethernet settings	46
2.5.3 Changing the Ethernet Settings	47
2.6 ABOUT VNC AND ZERO-CONF NETWORKING	48
2.6.1 About VNC (Virtual Network Computing)	48
2.6.2 About zero-configuration networking	48
3 NETWORK STREAMING	49

3.1	THE UPNP PROTOCOLE	49
3.2	UPNP NETWORK ARCHITECTURE.....	49
3.3	RECOMMENDED UPNP SOFTWARE.....	50
4	DAILY OPERATIONS	52
4.1	AVAILABLE USER INTERFACES	52
4.2	USING THE FRONT PANEL	53
4.2.1	Power On-Off Sequence	53
	Volume control.....	54
	Source selection	54
	Preset selection	54
4.2.2	Checking the format of incoming audio	55
4.3	USING THE IR REMOTE CONTROL.....	56
4.3.1	Volume control	56
4.3.2	Source selection	56
4.3.3	Listening format Selection.....	56
4.3.4	Presets selection	57
4.3.5	Access to the Front Panel menu.....	57
4.3.6	Light Button	57
4.3.7	Level and Delay Adjustment Bypass	57
4.4	USING THE GRAPHICAL INTERFACE	58
4.4.1	Volume control	58
4.4.2	Source selection	58
4.4.3	Preset selection	59
4.4.4	Checking the format of incoming audio	59
5	BASIC SETTINGS	60
5.1	NAMING YOUR SOURCES	60
5.2	CONFIGURING YOUR SOURCES	61
5.3	DEFAULT SOURCE CONFIGURATION	63
5.4	LEVEL AND DELAY ALIGNMENT OPTIONS	64
5.5	NAMING, SAVING AND LOADING PRESETS.....	65
5.6	DEFAULT PRESET	66
5.7	SET A MAXIMUM VOLUME	67
5.8	SET THE DIM LEVEL	68
5.9	BACKUP/RESTORE OF PRESETS	68
6	OVERVIEW OF THE SETUP PROCEDURE	70
7	ESSENTIAL TOOLS AND SETTINGS.....	71
7.1	AUDIO CLOCK SETTINGS	71
7.1.1	Audio clock status information.....	71
7.1.2	Audio clock setup	72
7.2	METERING THE INPUTS AND OUTPUTS.....	73
7.3	PLAYING PINK NOISE ON THE SPEAKERS	74
7.4	SOLO/MUTE AN INPUT OR AN OUTPUT	75
7.5	SWITCHING LEVEL AND DELAY ADJUSTMENTS ON/OFF	76
7.6	VIEWING THE ACOUSTICAL GRAPHS	77
7.6.1	Important notes	78
7.6.2	Graphs display options	78
7.6.3	Choose display options according to your requirements.....	79
8	SPECIFY THE SPEAKER LAYOUT	81
8.1	OVERVIEW OF THE SPEAKERS SETUP PROCEDURE	81
8.2	INTRODUCING THE SPEAKER/ROOM SETUP TOOL.....	81
8.3	AN EXAMPLE OF A SPECIFIC SPEAKER LAYOUT	83
8.4	AVAILABLE INITIAL LAYOUTS	84
8.5	SELECT AN INITIAL SPEAKER LAYOUT	85
8.6	ADDING SPEAKERS.....	86
8.6.1	Adding Regular Speakers.....	86
8.6.2	Adding Dolby Enabled Upfiring speakers.....	87
8.7	REMOVING SPEAKERS.....	88
8.8	CONFIGURE THE SETTINGS OF EACH SPEAKER	88
8.9	CONFIGURE THE CROSSOVER SETTINGS (OPTIONAL)	90
8.10	MAPPING THE CHANNELS OF DIFFERENT FORMATS.....	90

8.11	SEND PINK NOISE TO VERIFY THE ROUTING OF THE SPEAKERS.....	91
8.12	SAVE THE PRESET	92
9	SPECIFY AN ARRAY OF SPEAKERS.....	93
9.1	SETTING UP AN ARRAY OF SPEAKERS	93
9.2	EXAMPLE OF AN ARRAY OF SPEAKERS	94
9.3	ADJUST THE GAIN.....	94
9.4	SAVE THE PRESET	95
10	DECODER / UP-MIXER SETTINGS	96
10.1	SUPPORTED DECODERS/UP-MIXERS	96
10.2	LISTENING FORMATS	97
10.3	USING THE FRONT PANEL.....	101
10.3.1	<i>Listening format selection</i>	101
10.3.2	<i>Decoders Configuration</i>	101
10.4	USING THE GRAPHICAL INTERFACE	102
10.4.1	<i>Listening formats selection</i>	102
10.4.2	<i>Decoders Configuration</i>	102
10.5	DECODERS SETTINGS	103
10.5.1	<i>General Settings</i>	103
10.5.2	<i>Dolby decoder settings</i>	104
10.5.3	<i>DTS decoder Settings</i>	105
10.5.4	<i>Auro-3D decoder settings</i>	106
11	GETTING READY FOR CALIBRATION.....	107
11.1	VERY IMPORTANT TIPS.....	107
11.2	CHECKLIST BEFORE YOU START.....	107
11.3	IMPORTANT RECOMMENDATIONS FOR MICROPHONE PLACEMENT	108
11.3.1	<i>Requirements for the measurement environment</i>	108
11.3.2	<i>Reference measurement point</i>	108
11.3.3	<i>Position and orientation of the microphone for the reference point</i>	108
12	CALIBRATE THE ACTIVE CROSSOVERS (OPTIONAL).....	110
12.1	OVERVIEW OF THE CROSSOVER SETUP PROCEDURE.....	110
12.2	CONFIGURE THE ADVANCED SETTINGS (OPTIONAL).....	111
12.3	ADJUST THE MASTER OUTPUT LEVEL	113
12.4	CALIBRATE THE ACTIVE CROSSOVERS.....	114
12.5	VERIFY THE SOUND OF THE CALIBRATED CROSSOVERS	115
12.5.1	<i>Visualize the acoustical graphs for each speaker</i>	115
12.5.2	<i>Listen to each speaker connected to the crossover</i>	117
12.6	SAVE THE PRESET	117
13	LEVEL AND DELAY CALIBRATION	118
13.1	OVERVIEW OF THE CALIBRATION PROCEDURE.....	118
13.2	ADJUST THE MASTER OUTPUT LEVEL	118
13.3	NORMAL CALIBRATION SEQUENCE	119
13.4	COMMON PROBLEMS DURING CALIBRATION	120
13.5	CALIBRATION STATUS	120
13.6	CHECKING THE SPEAKER SUMMARY AFTER CALIBRATION	121
13.7	MULTI-POINT MEASUREMENTS (OPTIONAL).....	124
13.8	COMPUTE THE OPTIMIZATION FILTERS	124
13.9	SAVE THE PRESET.....	125
14	SETUP BASS MANAGEMENT.....	126
14.1	OVERVIEW OF THE BASS MANAGEMENT SETUP PROCEDURE.....	126
14.2	FULLY CUSTOMIZABLE BASS MANAGEMENT	127
14.3	BASS MANAGEMENT MODE.....	128
14.4	QUICK SETUP MENU	130
14.4.1	<i>Set Filters</i>	131
14.4.2	<i>Apply to selected speakers</i>	131
14.5	BASS MANAGEMENT SETTINGS FOR INDIVIDUAL SPEAKER	132
14.6	LFE & MISC	133
14.6.1	<i>Low Frequency Effect Setup</i>	133

14.6.2	+10 Db on LFE.....	133
14.6.3	Stacked Sub Correction	134
15	SETUP TARGET CURVES	135
15.1	OVERVIEW OF THIS PROCEDURE	135
15.2	SETTING UP ONE OR MORE TARGET CURVES	135
16	VERIFY THE SOUND OF YOUR OPTIMIZED SPEAKER SYSTEM	137
16.1	VISUALIZE THE ACOUSTICAL GRAPHS FOR ALL SPEAKERS.....	137
16.2	LISTEN TO THE SYSTEM	138
17	FINE TUNING OPTIMIZATION SETTINGS	139
17.1	MAIN OPTIMIZATION SETTINGS	139
17.2	SPEAKER POSITION REMAPPING	ERROR! BOOKMARK NOT DEFINED.
17.3	TARGET CURVE	141
17.4	LIMITER CURVE	141
17.5	ADVANCED OPTIMIZATION SETTINGS	142
17.5.1	Display	142
17.5.2	Front & Surround Speaker settings.....	142
17.5.3	Acoustics Correction	143
17.5.4	Calibration settings.....	143
17.5.5	Optimize according to L&R speakers settings.....	143
17.5.6	FIR and IIR settings.....	143
17.5.7	Level alignment settings.....	144
17.5.8	Subwoofer low-pass filter settings	144
17.5.9	Decimation settings & Advanced FIR settings.....	144
17.5.10	Advanced FIR settings	144
18	PERFORMING MULTI-POINT MEASUREMENTS	145
18.1	RELEVANT MEASUREMENT POSITIONS	146
18.2	MULTI-POINT CALIBRATION PROCEDURE	147
18.3	WEIGHTING MULTIPLE MEASUREMENTS.....	147
19	APPENDIX.....	148
19.1	INSERT AN EXTERNAL STEREO DAC	148
19.2	REMOTE START AND STOP.....	148
19.3	AUTOMATION	148
19.4	SIGNAL FLOW OF THE SDP-75	149
19.4.1	Setup Process and filters calculation	149
19.5	3D SPEAKER PLACEMENT RECOMMENDATIONS.....	149
19.6	DB25 CONNECTOR: ANALOG PINOUT	150
19.7	DB25 CONNECTOR : AES PINOUT	150
19.8	3D MEASUREMENT MICROPHONE	151
19.8.1	Microphone specifications	152
19.8.2	Power supply	152
19.8.3	Individual compensation file.....	152
19.8.4	Connection order	154

1 INTRODUCTION

The JBL SDP-75 defines the state-of-the-art in surround sound processors in terms of sound quality, seamless "3D" immersive audio, true decoding of up to 32 channels* in Dolby Atmos, seamless, optimized decoding and processing of all currently-available surround CODECs, utilizing HARMAN's newest research-based on-board room correction. The SDP-75 is part of a JBL Synthesis or Revel-based ecosystem, which optimizes numerous parameters based on easy-to-use drop-down speaker model selections.

Utilizing an Intel®i7 PC-based platform, only the JBL SDP-75 offers all these features, as well as a future-resistant on-line update capability that no DSP-based system can match. 64-bit floating point calculations and 24-bit/192kHz native processing assures the highest sound quality from virtually any source, and without re-clocking, which is the case for virtually every other surround processor, and which results in a significant sonic compromise.

A user-friendly web-based interface for both setup, calibration and run-time operation allows remote setup, operation and diagnoses via IP. An exclusive 3D speaker configuration tool simplifies arraying speaker groups, optimization of speaker functionality based upon codecs, and convenient channel identification. Internal gigabit Ethernet, and full host Wi-Fi simplify setup and operation.

*16, 24, and 32-channel versions of the SDP-75 are available.

About this guide

This guide includes the most important information you need in order to use and setup the SDP-75 in your home theatre system. From the most frequent daily operations to advanced calibration functionality, this document will guide you through every step of the task you wish to accomplish.

This guide is organized in the following parts:

PART I: GETTING STARTED WITH THE SDP-75:

Introduction: unpacking the SDP-75 and an overview of the hardware and the software.

Network Setup: setting up the network to start using the software.

PART II: USING THE SDP-75 ON A DAILY BASIS IN YOUR HOME THEATRE:

Daily Operations: Explains how to perform simple operations such as power-on/power-off, volume control, source selection, preset selection and decoder settings via the front panel, with the IR remote control or through the software user interface.

Basic Settings: Explains how to name and configure your sources, how to switch on/off the level and delay alignment options, how to manage presets, and how to backup/restore presets to/from a USB memory stick.

PART III: INTEGRATING THE SDP-75 IN YOUR HOME THEATRE SYSTEM:

Overview of the setup procedure: A summary of the main steps you must follow in order to successfully integrate the SDP-75.

Essential tools and settings: Provides important information about the software tools and settings you need to know before starting the setup process.

Specify the Speaker Layout: How to provide the SDP-75 with all the information about your set of speakers. This information is required for the delay and level alignment of the speakers in the room.

Specify an Array of Speakers: Provides information to setup an array of speakers.

Decoder/Up-mixer Settings: Provides necessary information on the different decoders supported, their up-mixer and the settings available.

Getting ready for delay and level alignment: Provides important tips and recommendations you need to know before running the calibration procedure, including tips about *microphone placement*.

Setup Bass Management: Explains the advanced bass management options supported by the SDP-75.

ADDITIONAL INFORMATION ABOUT THE SDP-75 SURROUND PROCESSOR:

Appendix: Technical information about automation, the signal flow, the 3D speaker placement recommendations, connector pinouts.

To improve clarity throughout this document, references to user interface items will be shown in **bold** letters and illustration's caption will be shown in ***italic bold*** letters.

This guide also includes information about the latest 3D formats and common practice in terms of speaker placement to help you understand the new approach of 3D Sound in the best possible and least confusing way.

In addition, important information will be indicated with the following symbols.



NOTE



IMPORTANT NOTE

Record of Changes:

Date	Software version
------	------------------

July 2016	Software version 4.0.10 – First Production Release
April 2017	4.1.x



IMPORTANT NOTE: The content of this document is subject to change without notice.

1.1 PRODUCT INFORMATION

MAIN FEATURES	
<ul style="list-style-type: none"> • 16 or 32 Channel Digital Audio Processor • Universal Spatial-Accurate 3D Audio playback • Best-in-class Room Optimization fully integrated • Superior multi-subwoofer management and active crossovers calibration • 118 digital and analog inputs + 80 audio outputs 	<ul style="list-style-type: none"> • 8x HDMI Inputs, 2x HDMI Outputs • User-friendly, self-explaining user interface • Built-in Wi-Fi & UPnP/DLNA Compliant Digital Media Renderer • Wide choice of Remote Options
EXCLUSIVE TECHNOLOGIES	SUPPORTED AUDIO/VIDEO FORMATS
<ul style="list-style-type: none"> • Trinnov Room Optimization • Next Generation Hardware platform: • Revolutionary architecture, scalable processing platform • 64 bits floating point & 24 bits / 192 kHz native processing • Future-resistant software-oriented upgrades provided over internet, no DSP upgrade required • Robust design, inspired from our professional audio product lines • High-performance AD/DA converters, used daily by the most demanding mastering studios 	<ul style="list-style-type: none"> • LPCM Audio: 16-channels AES input compatible with Digital Cinema Servers • 3D Audio Codecs (optional): Auro-3D, Dolby Atmos and DTS:X, including their respective up-mixers • HD Audio Codecs: Dolby TrueHD, DTS-HD Master Audio • HDMI 1.4a compliant digital audio with 4K and 3D video pass-through (HDCP 2.2 : HDMI input 1, HDMI output 2) • UPnP/DLNA renderer: WAV, AIFF, OGG, FLAC up to 24 bits / 192 kHz
	SUBWOOFER MANAGEMENT
	<ul style="list-style-type: none"> • Adjustable High-pass / Low-pass editable by individual satellite/sub or by group of speakers • Support from 0 to 32 subwoofers • Automatic level and delay
REMOTE MANAGEMENT	
<ul style="list-style-type: none"> • VNC Remote Control through the network from any smartphone, tablet or laptop • Web-based responsive interface • Automation via Telnet and RS232 protocols 	<ul style="list-style-type: none"> • Crestron, Savant, Control4 and AMX modules are available • Built-in Gigabit Ethernet and Wi-Fi • IR remote control included • 12V Trigger in/out
AUDIO PROCESSING	
<ul style="list-style-type: none"> • Comprehensive Processing latency control • Automatic Processing : <ul style="list-style-type: none"> • Multi-point acoustic measurement (Trinnov 3D measurement microphone) • Time/Frequency acoustic analysis based on impulse response measurement • Loudspeaker/Room optimization • Target Curves 	<ul style="list-style-type: none"> • Manual Processing • Several layers of 31 band Graphic EQ, FIR EQ, gains, polarity and delay available for every channel. • Total delay given in meters / milliseconds / frames for the listening point and adjustable global delay for accurate Lip Sync
PHYSICAL CHARACTERISTICS	

Chassis: 3.5U
Power supply: 240V AC / 50-60 Hz. *Option: 130V AC*
Consumption: 90 W max.
Weight: ~14.5kg
Environmental conditions:
- Operating: 0°C-40°C (32°F-104°F)
- Humidity: 20%-80% relative humidity (without condensation)



1.2 SYSTEM INTEGRATION

The SDP-75 is inserted before loudspeakers.



Figure 1: SDP-75 system integration

1.3 JBL SYNTHESIS CERTIFIED INSTALLERS

The JBL SDP-75 surround processor provides an unprecedented degree of flexibility and automation, along with decoding of every current format and very flexible speaker configuration. All of this results in a superior end-user experience, with complex operations, such as automatically switching speaker configurations depending upon the format being transparent to the end-user. The SDP-75 should only be installed and calibrated by a certified JBL Synthesis Installer.

1.4 UNPACKING THE SDP-75

You will find in the SDP-75 packaging:



The SDP Synthesis SDP-75 Surround Processor



Remote Control



Power Cord



Wi-Fi Antenna



CR032 Battery



SDP-75 Quick Guide



Rack Ears

1.5 THE HARDWARE

1.5.1 FRONT PANEL LAYOUT



1.5.2 FRONT PANEL DISPLAY

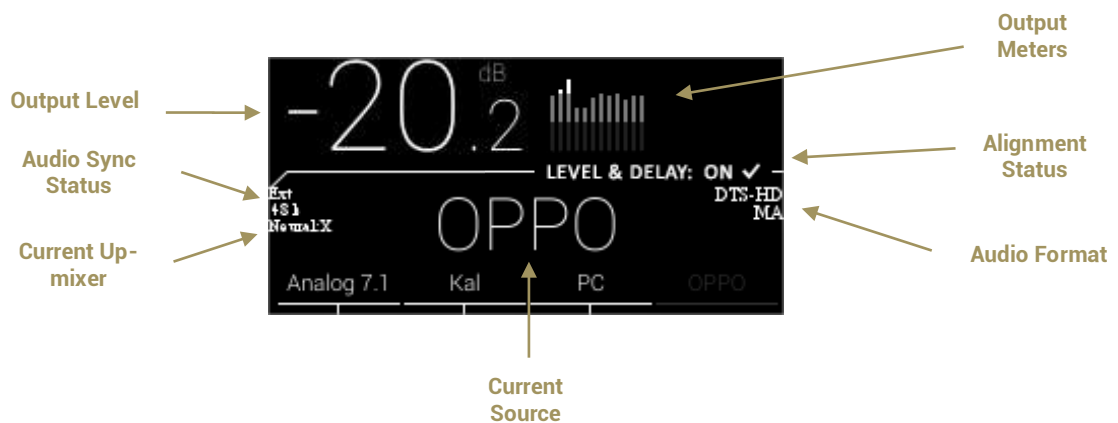

1.5.3 REAR PANEL LAYOUT

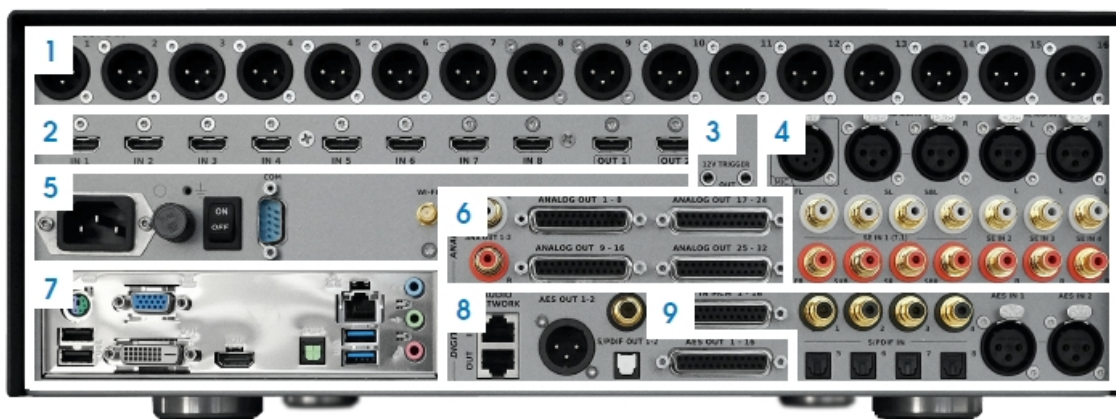

1 ANALOG OUTPUTS 1-16 ON XLR CONNECTORS

2 HDMI 1.4A 8 INPUTS, 2 OUTPUTS

3 TRIGGER 12V IN/OUT

7 PC CONNECTORS *may change following PC motherboard updates*

- Video output (VGA/DVI/HDMI)
- 2x USB 2.0 + 2x USB 3.0
- Parallel port (unused)
- PS/2 Keyboard/Mouse
- RJ45 Gigabit Ethernet
- Audio ports (unused)

4 ANALOG INPUTS

- 1x Microphone Input (*unused*)
- 2x Stereo Inputs on XLR
- 1x 7.1 Input on RCA
- 3x Stereo Inputs on RCA

8 DIGITAL OUTPUTS

- 1x AES3 (8 or 16 channels) on DB25
- 1x Stereo AES/EBU on XLR
- 1x Stereo S/PDIF on RCA
- 1x Stereo S/PDIF on Toslink
- 1x AML Extension link on RJ45

5 POWER

- AC Input
- Fuse
- Power Switch
- RS232
- Serial Number
- Wi-Fi Antenna Connector

9 DIGITAL INPUTS

- 1x AES3 DCI compliant (8 or 16 channels) on DB25
- 4x SPDIF on RCA / 1x 7.1 PCM
- 4x SPDIF on Toslink / 1x 7.1 PCM
- 2x Stereo AES/EBU on XLR

6 ANALOG OUTPUTS

- 1-32 on 4x DB25 Connectors
- 1x Stereo on RCA

1.5.4 IR REMOTE CONTROL

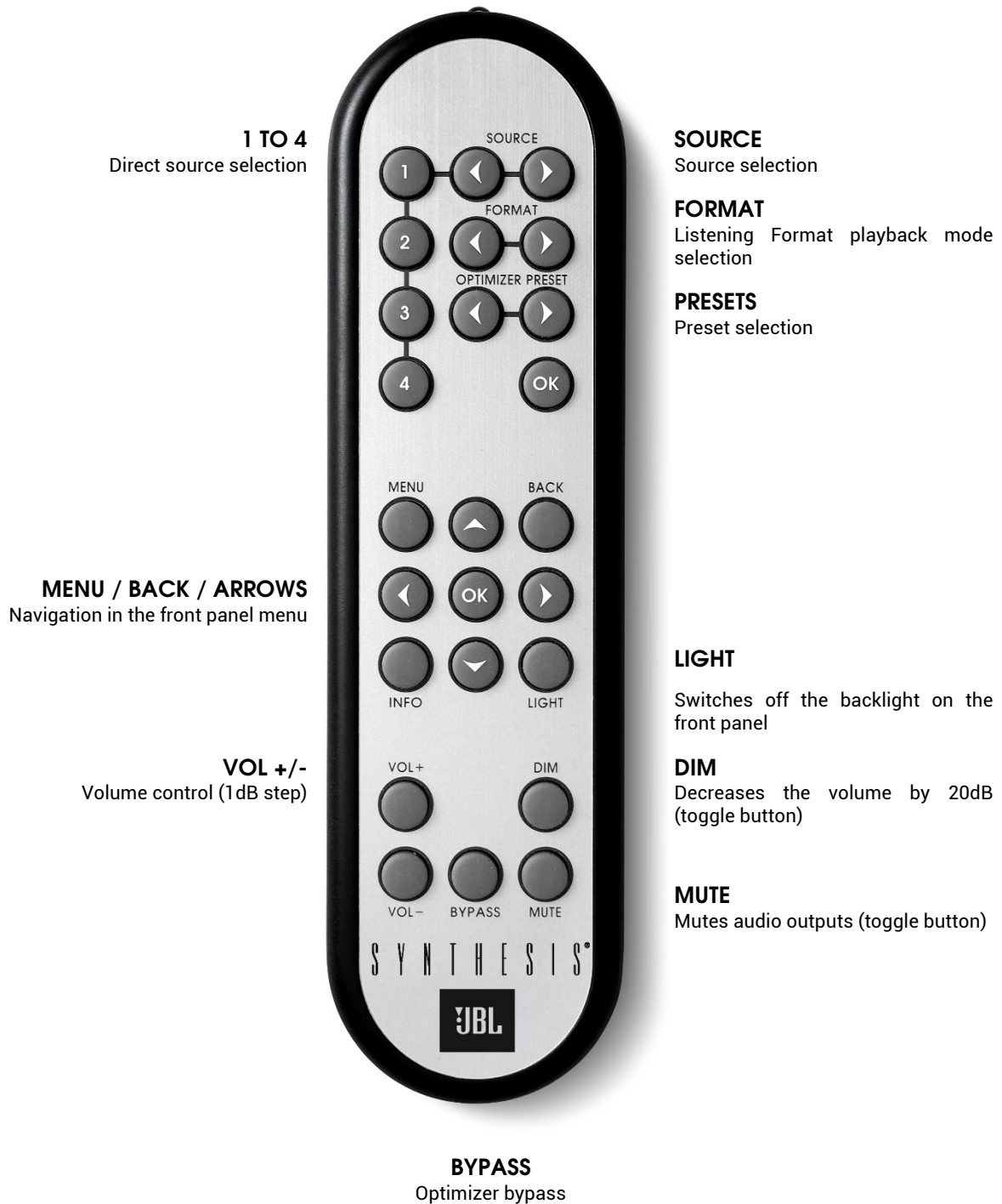

1.6 THE SOFTWARE

1.6.1 AVAILABLE OPTIONS TO ACCESS THE GRAPHICAL USER INTERFACE

The SDP-75 offers multiple options to display and control the user interface:

- **Directly** with a physical display, a mouse and a keyboard connected to the PC connectors of the SDP-75.
- **Remotely** with a **VNC Client** over the network, from any computer or tablet to access the full user interface in order to operate and/or setup the SDP-75.
- **Remotely** with an **internet browser**, with a *limited* access to the user interface allowing to operate the SDP-75 but without all the setup menus.

The Graphical User Interface of the SDP-75 is specifically designed for touch screen use but it is just as easy to use with your laptop's trackpad or with a mouse.

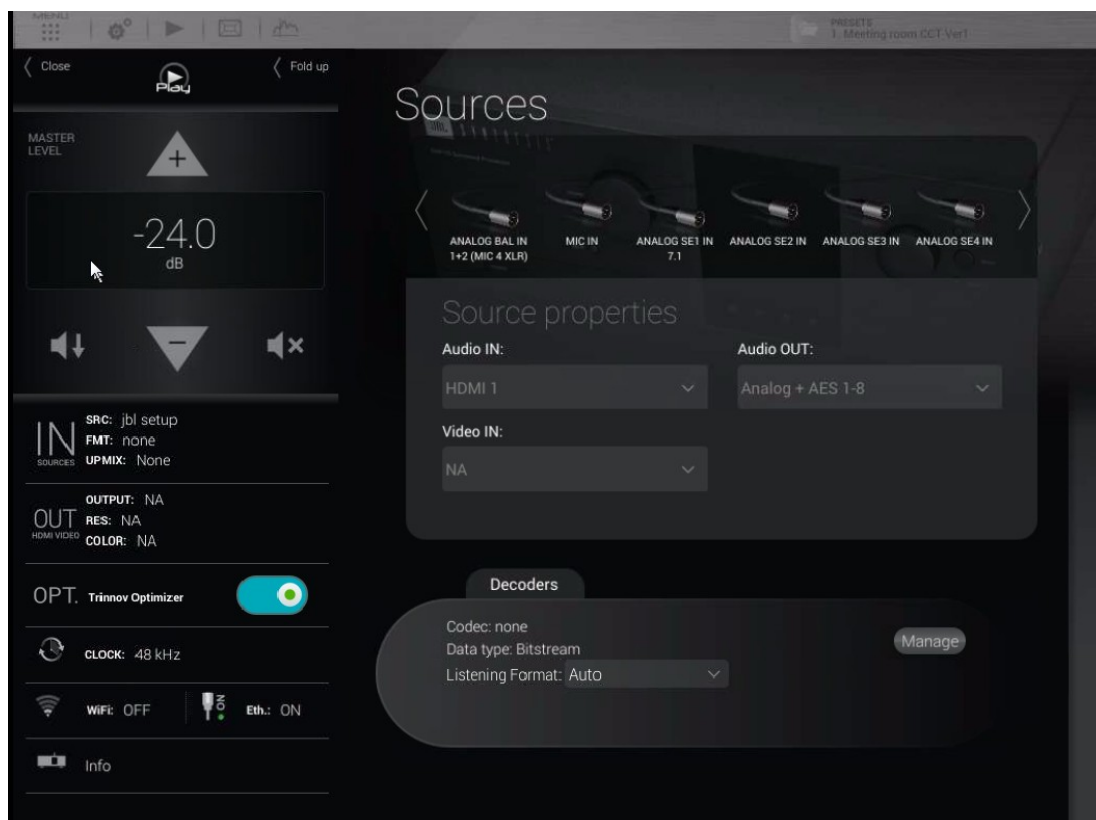

Figure 2: graphical user interface of the SDP-75



NOTE: The design and the user experience of the SDP-75's Graphic User Interface are constantly improved with software updates.

1.6.2 IMPORTANT NOTE ABOUT THE WEB-BASED INTERFACE

The SDP-75's full user interface can only be accessed by connecting a display or through a VNC client.

If you've already completed the setup of the SDP-75 in your home theatre system and you only need to operate it, a *limited part* of the SDP-75's user interface is also available from a *web browser*.



NOTE: The web browser can only display the *HTML-based pages* of the user interface. However, most of the system setup pages of the SDP-75 are currently *Linux-based*. Therefore, the web browser can only be used for daily operations of the SDP-75 but cannot be used to setup, measure and align the level and delay of your speaker system.

To connect to the web user interface of the SDP-75's you need to enter its **IP address** in your web browser.

The **IP address** of the SDP-75 can be retrieved:

- via the front panel: go to the **Setup/Network/Ethernet** menu.
- by connecting a monitor and a mouse to the back panel. Go to the **Network** page of the graphical user interface.

If you are *already connected* to the SDP-75 with a VNC Client, you can easily check its **IP address**:

- Using *Mocha VNC*: click on the blue arrow, located at the right of the VNC Server address field;
- Using *Chicken VNC*: select the SDP-75 from the server list.

Please refer to the **Network Setup** chapter for further details about network configuration.

1.6.3 USING A DISPLAY, MOUSE AND KEYBOARD CONNECTED TO THE SDP-75

A very straightforward option to access and control the user interface of the SDP-75, provided that you have the necessary equipment, is to connect a physical display and use a mouse and a keyboard to control the SDP-75 software.

These devices shall be connected to the PC's connectors, located on the rear panel of the SDP-75:

- PC/Mouse can be connected either using the **PS/2** or **USB** ports.
- Physical monitor can be connected through the **VGA**, **DVI-D** or **HDMI** ports. *The PC video outputs may change following the mother board reference.*

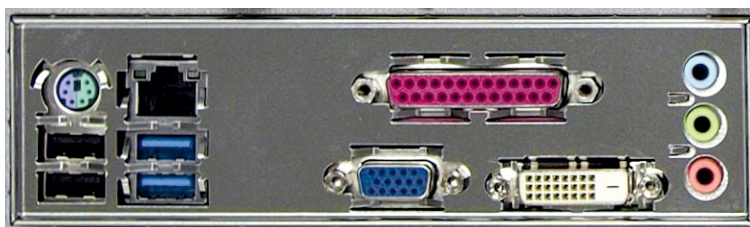

Figure 3: SDP-75 PC connector's panel

1.6.4 THE TOP MENU BAR

The Top Menu provides access to the main features of the SDP-75.



Opens the **Advanced settings** graphical user interface, used for configuring your sources, level and delay alignment, advanced processor settings, network setup, etc. Most of its functionality is explained in the chapters **Calibrate the Speakers in the Room** and **Tuning the Optimization Settings**.



Opens the lateral **Play menu** used for daily operation: level adjustment, source selection and general information. See the chapter **Daily Operations**.



Opens the **Speakers/Room setup tool**, used for setting up your speaker system and for routing the channels to the speakers. See the chapter **Specify the Speaker Layout**.



Opens the **Fine Tuning page**, which includes the Bass Management and the Advanced Settings. See the chapters **Setup Bass Management** and **Tuning the Optimization Settings**.



is a drop-down menu useful for quickly selecting a preset.

1.6.5 THE MAIN USER INTERFACE

The main page of the SDP-75 is used for daily operation:

1. Click on the Play button on the top left corner of the interface: the lateral menu unfolds,
2. Select one of the tabs to open the corresponding panel. For example, the **Input Sources** tab opens the **Sources** panel,
3. Perform a daily operation, such as selecting a different source.

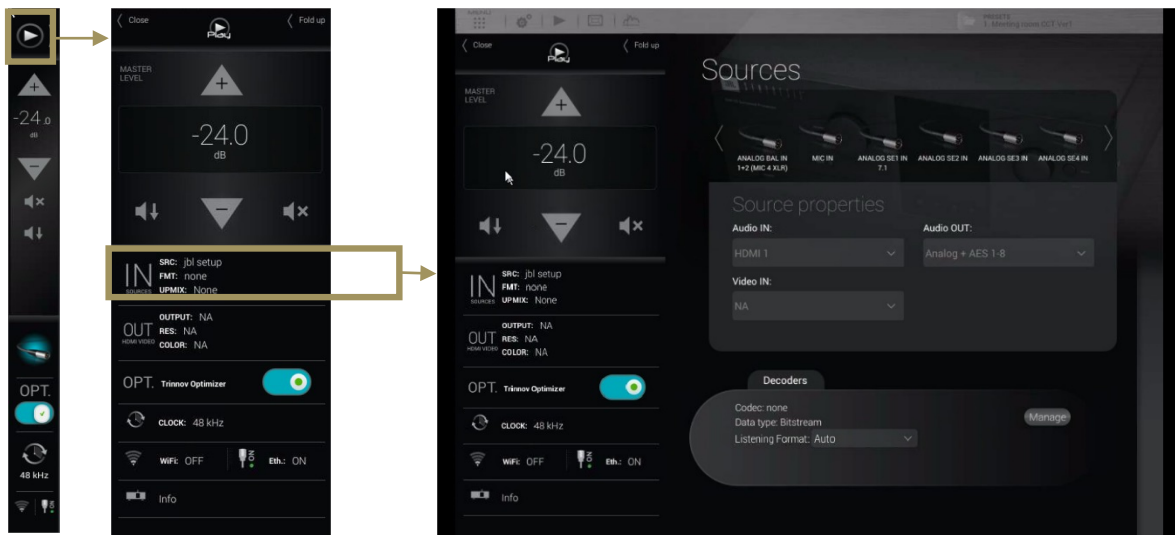

A detailed description of this interface is provided in the following pages.

1.6.6 THE LATERAL MENU BAR









You can access the Play menu, located on the left-hand side of the user interface, at any time by clicking on the "Play" button on the Top menu.

This menu constantly provides information about the **current status** of the SDP-75. It can be **folded** or **unfolded** depending on the task you wish to perform.

1.6.7 FOLDED LATERAL MENU

When folded, the lateral menu provides the following features:

	Click to unfold the lateral menu.	Unfold button
	Click to increase output level added in 1dB steps.	Volume Control
	Displays the current output level.	
	Click to decrease output level added in 1dB steps.	
	Mute: cuts all outputs.	
Dim: attenuates the output level by 20dB.		
	Displays which audio source is currently selected as you move the cursor over the icon.	Source Information
	Displays the current status of the Optimizer. Click to enable/disable the Optimizer.	Optimizer Status
 48 kHz	Displays the current clock sampling rate.	Audio Clock
	Displays the current status of the Wi-Fi and Ethernet network interfaces of the SDP-75.	Network Status

1.6.8 UNFOLDED LATERAL MENU

When unfolded, the lateral menu displays extra information about the current settings of the SDP-75:

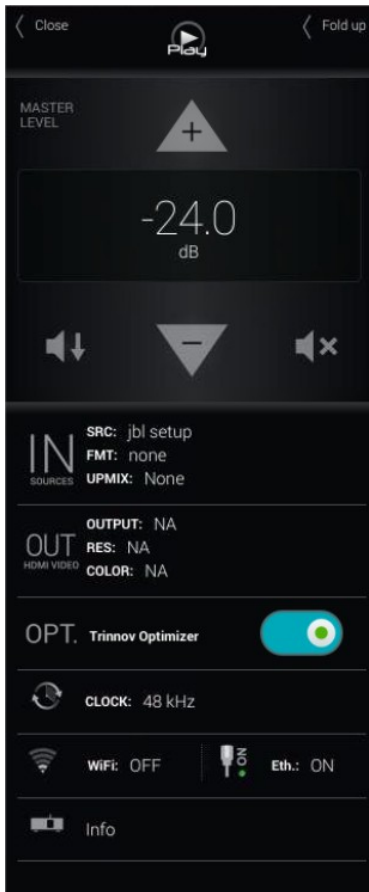

IN sources	<ul style="list-style-type: none"> • SRC: the name of the current audio source • FMT: the audio format • UP-MIX: The up-mix format
OUT channels	<ul style="list-style-type: none"> • EQ: the current user EQ • OUT: the current audio output
OPT displays the current status of the Optimizer.	
CLOCK displays the current sampling rate.	
Wi-Fi and Ethernet network status	
More information on your SDP-75	

1.6.9 THE SPEAKERS/ROOM SETUP TOOL

The speakers/room setup tool is a highly practical tool used to setup your system. It is explained in the **Specify the Speaker Configuration** chapter.

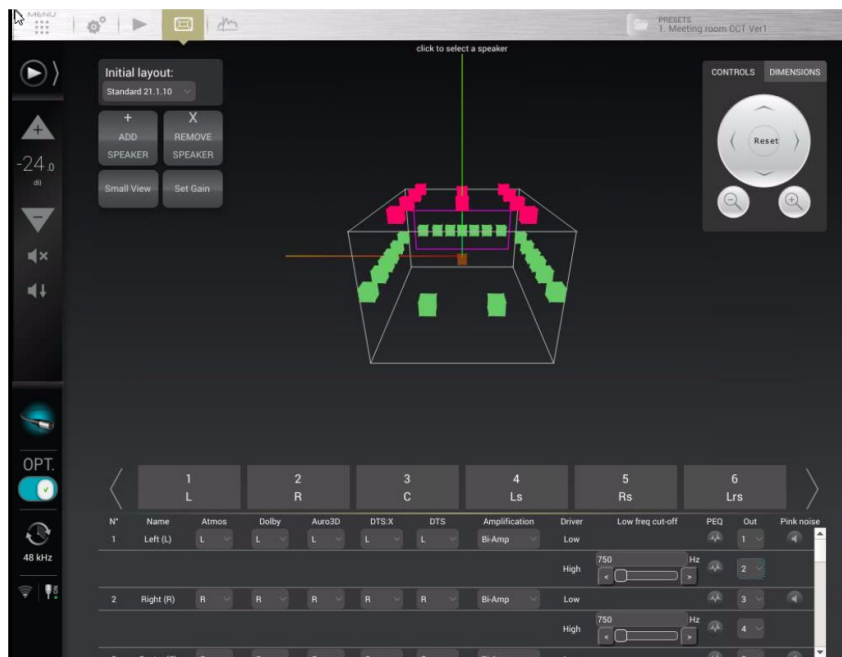
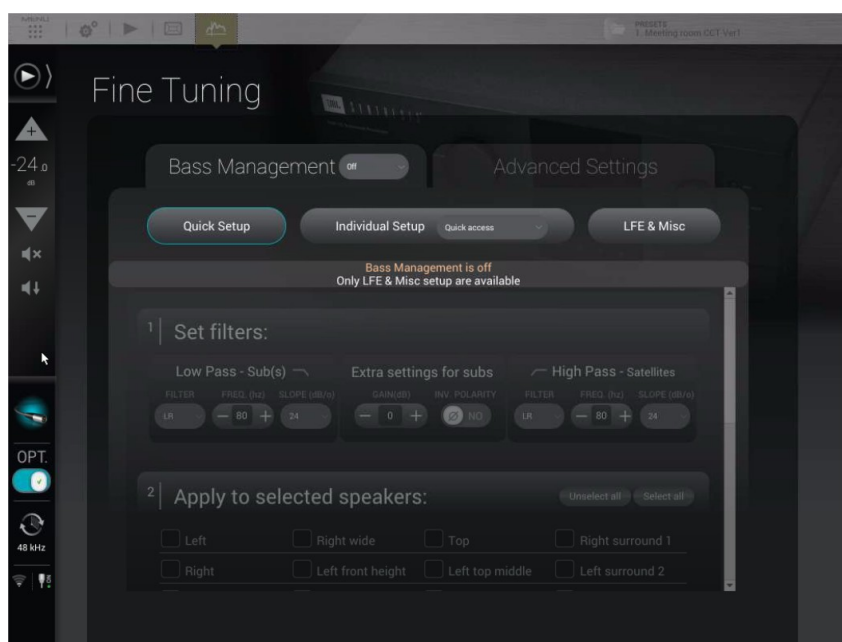

Figure 4: The Speakers/Room setup tool

1.6.10 THE FINE TUNING PANEL

The Fine Tuning panel gives access to **Bass Management** and **Optimizer settings**:



1.6.11 THE ADVANCED SETTINGS INTERFACE

The advanced settings of the SDP-75 are currently available through a specific user interface:

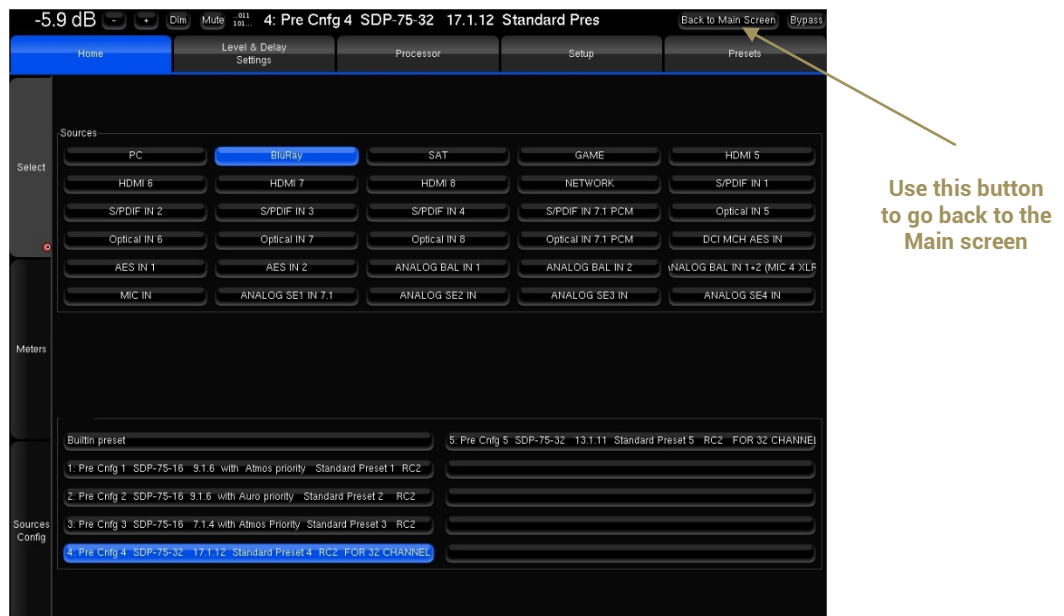
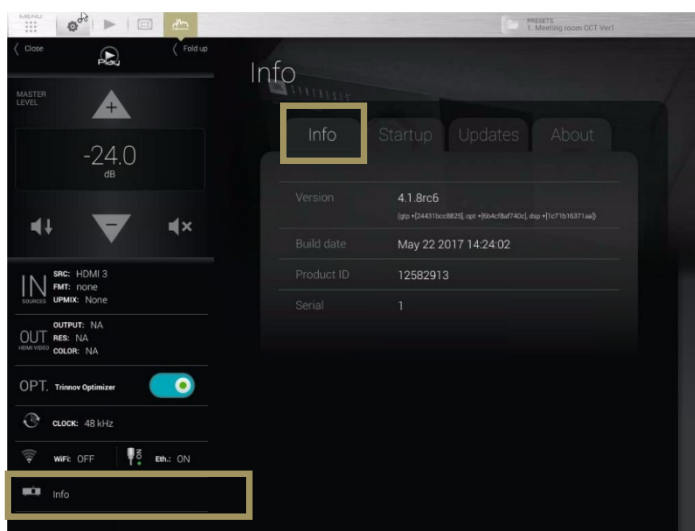

Figure 5: The advanced settings user interface of the SDP-75

1.6.12 PRODUCT INFORMATION

Product Information can be displayed on the Graphical User Interface default startup page and/or on the front-panel menu of the SDP-75.



- **Version:** software version currently installed
- **Build date:** software release build date
- **Product ID:** SDP-75 unique ID number of the unit
- **Serial:** serial number of the unit

Figure 6: Product information page

To display the About page on the front panel, hit the **Menu** button on the front panel of the SDP-75, select the last item **About** and hit the **Select** button.

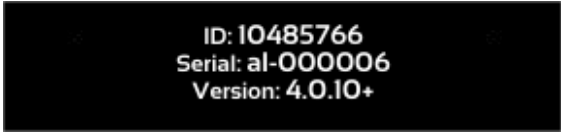

Figure 7: The front-panel About page

1.6.13 SOFTWARE UPDATES

The SDP-75 was designed to maintain its leadership over time and will therefore benefit from continuous updates as well as new features.

Software updates and support can be performed remotely by JBL Synthesis provided that the Processor is connected to the internet and that outgoing connections to port 22 is open.

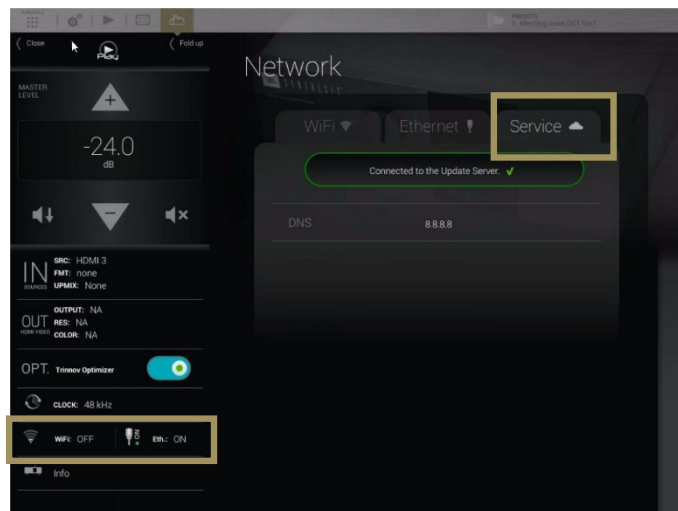

Figure 8: The Network/Service page

2 NETWORK SETUP

This chapter explains how to connect with your preferred device (tablet, laptop or desktop computer) to the SDP-75 through a Wi-Fi or Ethernet network.

2.1 CHOOSING A NETWORK CONFIGURATION

The SDP-75 offers multiple network options in order to meet two important requirements:

- using a wireless device (tablet or laptop computer) throughout the room while performing acoustical measurements with the SDP-75's level and delay alignment tools;
- seamlessly integrating the SDP-75 into your home theatre's technical environment;

Depending on the specific technical environment of your home theater, each of these requirements may or may not correspond to the same network configuration.

We recommend the following strategy for the network setup of your SDP-75:

1. **Setup Procedure:** choose a network configuration that meets your requirements for the setup process. Three options are possible:
 - A. The SDP-75 joins your local Wi-Fi network as a Wi-Fi client;
 - B. The SDP-75 joins your local Ethernet network as an Ethernet client;
 - C. Your device connects to the SDP-75's own Wi-Fi network (Access Point).
2. **Final installation:** if needed, change the network configuration to meet the requirements to integrate the SDP-75 into your overall home theater system. For the final installation of the system, we suggest to leave your SDP-75 permanently connected to the local network. Two options are possible:
 - A. Connect an Ethernet cable between the SDP-75's back panel and your ISP box. With this option, the SDP-75 will always be available through your local network. This is the easiest option because the SDP-75's default DHCP network settings allows it to connect automatically to a local Ethernet network.
 - B. Setup the SDP-75 network settings to connect as a Wi-Fi client to your ISP Box's Wi-Fi access point. This process is explained in the **Advanced Wi-Fi Settings** subchapter at the end of this chapter.



NOTE: You could also choose to leave the SDP-75 disconnected from your local network but this will probably be less convenient if you want to access the Internet from the same device that is used to operate the SDP-75.



IMPORTANT NOTE: Whatever option you choose for connecting to the SDP-75 through a network, please keep in mind that the SDP-75 and your control device (tablet or computer) must be connected to *the same network*, or to interconnected networks, such as a Wi-Fi network interconnected to an Ethernet network.

2.2 CONNECTING TO THE SDP-75

2.2.1 OVERVIEW OF THE NETWORK CONNECTION PROCEDURE

The factory settings of the SDP-75 are designed to make it as easy as possible to establish the first network connection between your device (tablet or computer) and the SDP-75 so that you can access its graphic user interface.



IMPORTANT NOTE: Please keep in mind that another straightforward option for using the SDP-75 is to connect a display, mouse, and keyboard directly to the back panel PC connectors.

The following overview introduces the main steps of the network connection procedure in order to help you understand the overall process and choose your preferred options:

1. **Step 1:** download and install a *VNC Client* software application on your device.
2. **Step 2:** put the SDP-75 and your device on the same network. Choose one of these options:
 - A. Your device joins the SDP-75's Wi-Fi network: *Disconnect* your device from your *usual* Wi-Fi network and *connect* it to the SDP-75's own Wi-Fi network (Access Point).
 - B. The SDP-75 joins your existing Wi-Fi network: use the SDP-75's front panel menus to connect it to your local Wi-Fi network.
 - C. The SDP-75 joins your existing Ethernet network: use an Ethernet cable to connect the SDP-75 to your local Ethernet network.
3. **Step 3:** open your VNC Client and configure it to connect to the SDP-75's VNC Server. Choose one of these options:
 - A. iOS devices, Android devices or Mac OS X computers: the zeroconf-enabled VNC clients available for these devices *will not require* knowing the IP address of the SDP-75.
 - B. Windows computers: you will need to configure your VNC client (*Tight VNC*) with the IP address of the SDP-75.
4. Once your VNC Client is configured correctly, connect to the SDP-75's VNC Server and start using the SDP-75's graphical user interface.

These steps are described in detail in the following pages.

2.2.2 STEP 1: DOWNLOAD AND INSTALL A VNC CLIENT ON YOUR DEVICE

2.2.2.1 USING A TABLET

If you are connecting from an iOS, Android or Windows tablet you need to download and install a VNC *Client* app on your tablet. A number of VNC Clients/Viewers are currently available. We recommend the *Mocha VNC Lite* free app:

iOS devices (Apple iPad): use the **App Store** app to download and install the **Mocha VNC Lite** app from Apple's App Store.



Android devices: use the **Play Store** app to download and install the **Mocha VNC Lite** app from Google's Play Store.



Windows mobile devices: use the **Windows Store** app to download and install the **Mocha VNC Lite** app from the Windows Store.



2.2.2.2 USING A MAC OS X COMPUTER

If you are connecting from a Mac OS X computer running OS X version 10.5 or higher, you can choose to use Apple's **Screen Sharing** VNC client integrated into the OS X operating system. In this case you don't need to download an additional app and you can skip to the next step.

If your Mac is running OS X version 10.4 or lower, you need to install a VNC client software: download and install **Chicken of the VNC** from www.macupdate.com

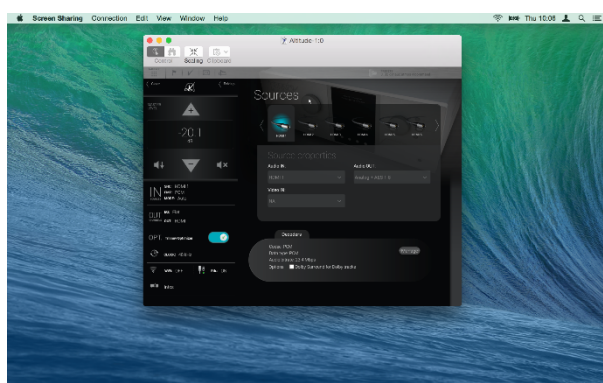

Figure 9: the SDP-75's graphical user interface from a Mac OS X desktop

2.2.2.3 USING A WINDOWS COMPUTER

If you are connecting from a Windows computer, you need to download and install a VNC *Client* software. A number of VNC Clients/Viewers are currently available.

We recommend *Tight VNC*: download and install **Tight VNC** from www.tightvnc.com

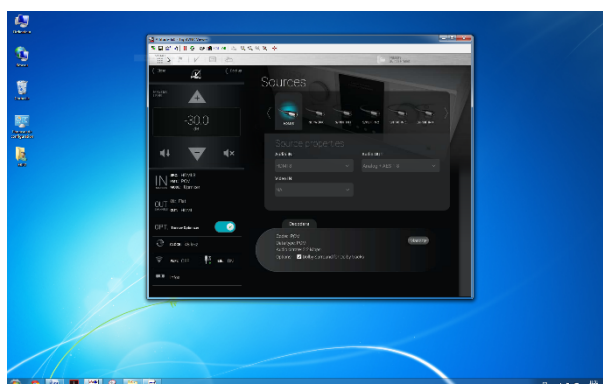

Figure 10: the SDP-75's graphical user interface from a Windows desktop



NOTE: Tight VNC is not *zeroconf-enabled*. You will need to enter the IP address of the SDP-75 in order to connect.

2.2.3 STEP 2: PUT THE SDP-75 AND YOUR DEVICE ON THE SAME NETWORK

2.2.3.1 OPTION A: YOUR DEVICE JOINS THE SDP-75'S WI-FI NETWORK

The factory settings of the SDP-75 are preconfigured to allow it to run as a Wi-Fi Access Point. Provided that the Wi-Fi antenna is connected to its back panel, the SDP-75 will run its own Wi-Fi Access Point. The SDP-75 access point should appear in the list of Wi-Fi networks under the name "SDP-XX", where XX is the serial number of your SDP-75.

The fully wireless option for connecting to the SDP-75 is as follows:

- Disconnect your device (computer or tablet) from your usual Wi-Fi network;
- Connect your device to the SDP-75's own Wi-Fi network: in your list of Wi-Fi networks, choose the network named "SDP-XX", where "XX" is the **serial number** of your SDP-75. Enter the following password: **calibration**
- Use the SDP-75 front panel to check its network status: go to the **Setup/Network** menu to see its IP address.

Once your computer or tablet is on the SDP-75's own Wi-Fi network, you can move to the *Next Step* of this procedure to configure and connect your VNC client to the SDP-75's VNC server.



IMPORTANT NOTE: The SDP-75 Access Point's password is **calibration**

The SDP-75's Access Point details are available through the front panel menu in the **Setup > Network > Wi-Fi** page.

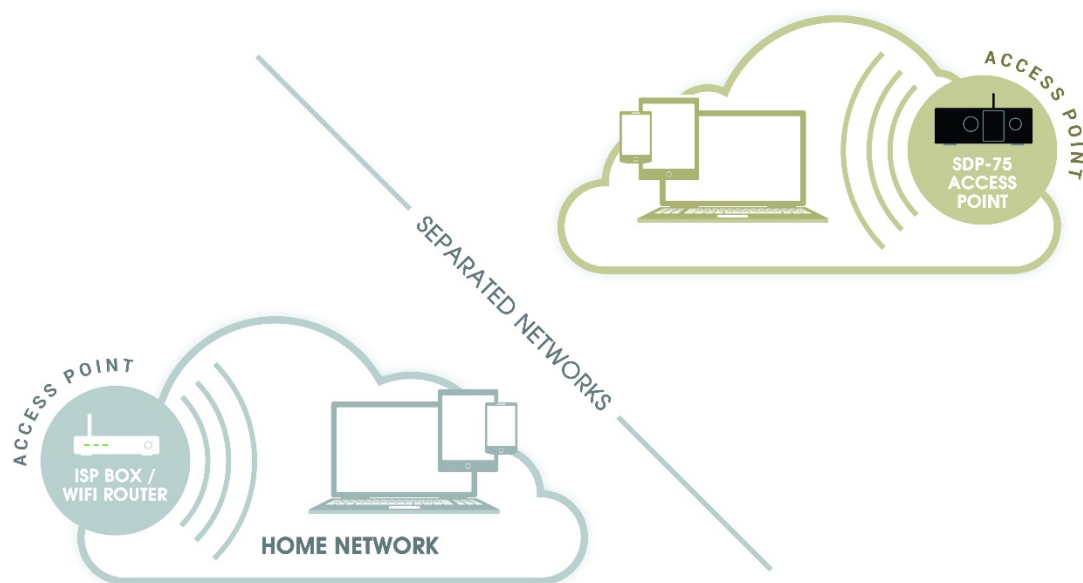



Figure 11: joining the SDP-75's network (Access Point)



IMPORTANT NOTE: Once connected to the SDP-75's Access Point, it is possible to remotely access the SDP-75's graphic user interface, but access to Internet will be lost, as indicated in the figure above. You must switch back to your usual Wi-Fi network in order to reconnect to the internet.

CONNECTING WITH YOUR IPAD

The following screenshots, created on an iPad, are provided as an example of how to connect to the SDP-75 Access Point. The process is extremely similar on a Mac OS X, Android, or Windows device, you simply need to find the **Wi-Fi Settings** page.

- Go to **Settings** and click on the **Wi-Fi** menu item located in the top left side of the page.
- In the "**Chose a network...**" list, click on the network **SDP-XX**, where XX is the serial number of your SDP-75.

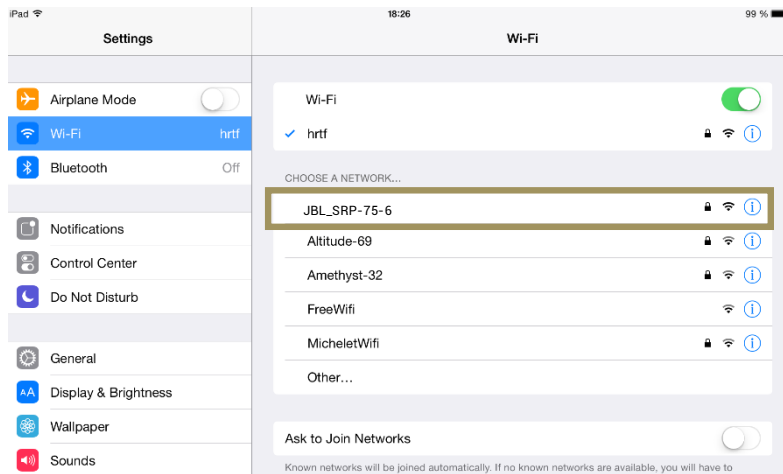

Figure 12: choosing a Wi-Fi network in the iPad settings

- When asked to Enter the password for "SDP-XX", type the following password: **calibration**
- Click on the Join button.
-

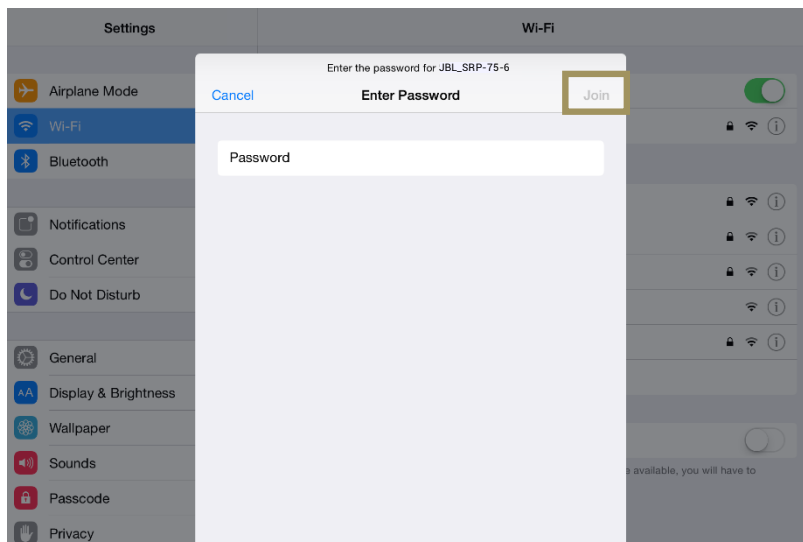

Figure 13: entering the password to join the SDP-75's Wi-Fi network

- You should now see the SDP-XX network as the currently connected Wi-Fi network on top of the page and on the top left side of the page:

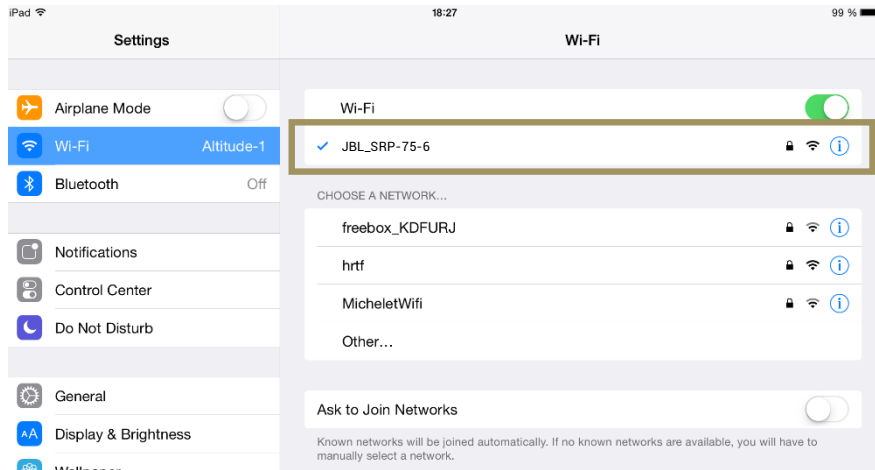

Figure 14: the iPad is now connected to the SDP-XX Wi-Fi network

Once you are connected, you can move to the next step of the procedure: configure and connect your VNC client to the SDP-75's VNC server.

2.2.3.2 OPTION B: THE SDP-75 JOINS YOUR EXISTING WI-FI NETWORK

The most flexible network option for the final installation of your SDP-75 is to connect it as a Wi-Fi client to *your existing Wi-Fi network*. This will allow you to connect to the SDP-75 and to the Internet *simultaneously*, without switching back and forth between two different Wi-Fi networks.

To connect the SDP-75 to an existing Wi-Fi network you need to use the front panel menus to change the Wi-Fi settings:

- Click on the menu button on the front panel.
- Select the Setup > Network > Wi-Fi page.
- Turn the Source/Item selection knob to scroll through the settings until you see the Connection item:
- Push the Select button. This will display the list of available Wi-Fi networks:
- Scroll to the name of the Wi-Fi network you want to join, and press the Select button. If you select an encrypted Access Point, you will be asked for the passphrase.
- Enter the passphrase and press the OK button:
- You should now see that the Wi-Fi status has changed to "Link: Connected":

This means that your SDP-75 is now connected to the chosen Wi-Fi network.

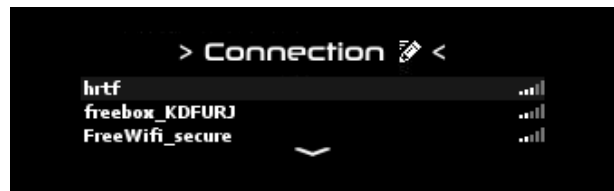
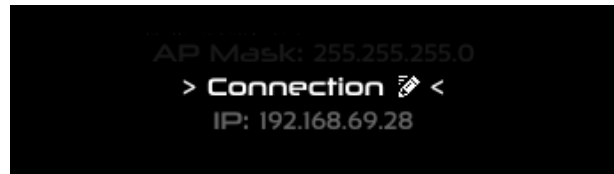

2.2.3.3 OPTION C: THE SDP-75 JOINS YOUR EXISTING ETHERNET NETWORK

The factory setting for the SDP-75's Ethernet mode is set to DHCP. Therefore, the SDP-75 will automatically be detected and configured on most local networks.

The benefit of this Ethernet-based option is that you don't need to switch your own device to another network. Therefore, if your network has Internet access, you will remain connected to the Internet while also being connected to the SDP-75.

To connect the SDP-75 to your local Ethernet network:

- Use an **Ethernet cable** to connect the SDP-75 to your router or ISP Box;
- Use the SDP-75's front panel to check that it now has an IP address: go to the **Setup/Network** menu to see the network configuration.

Once the SDP-75 is connected to your local network, you can move to the next step of the procedure: configure and connect your VNC client to the SDP-75's VNC server.

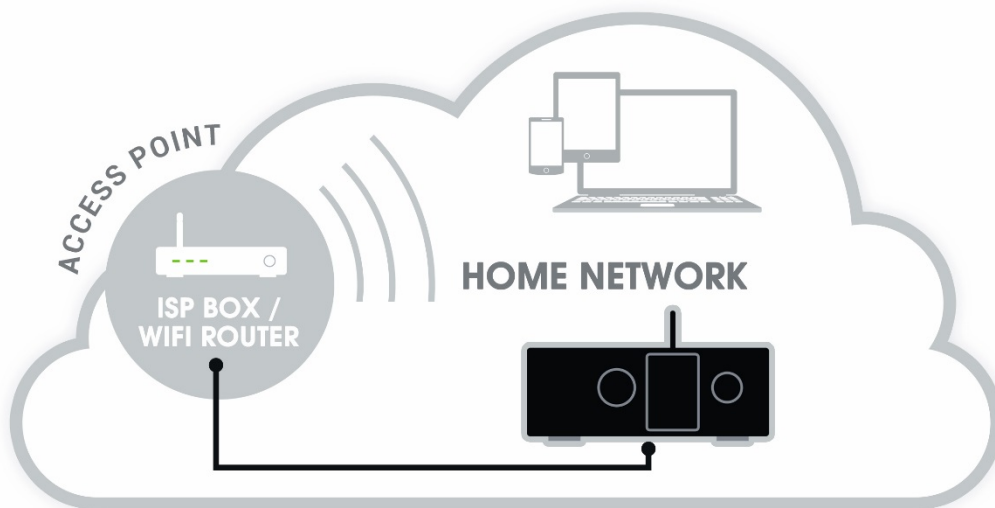

Figure 15: connecting the SDP-75 to an ISP box

The figure above shows that the SDP-75 is hard-wired to the Internet Service Provider Box / Wi-Fi Router of the local home network.

If your local network has a Wi-Fi Access Point, you can then access the SDP-75 from any wireless device connected to your local Wi-Fi Access Point.



NOTES:

- This configuration only works if the router includes an *active DHCP server*.
- The standard settings of your ISP box should allow the SDP-75 to reach the Updates Server for software updates through the internet.

2.2.4 STEP 3: CONNECT TO THE SDP-75 FROM YOUR DEVICE

2.2.4.1 USING A TABLET WITH MOCHA VNC LITE

To connect to the SDP-75's VNC Server from an iOS or an Android device, use the *Mocha VNC Lite* application:

- Open the Mocha VNC Lite app in your iOS or Android device.
- Click on the Configure menu item located in the top left of the page.
- In the Configure page, click on the line "New... Add a configuration".

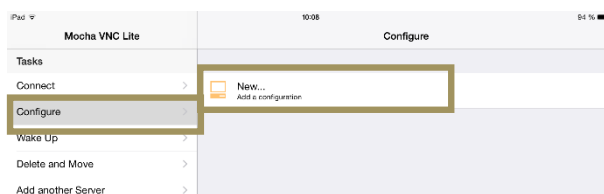

Figure 16: adding a new VNC Server configuration

In the list of VNC Server parameters, click on the "i" button located in the top right of the page, next to the VNC server address.



Figure 17: configuring the VNC Server

In the list **Find local workstations**, select the line named "#VNC Server on SDP-XX", where XX is the number of the SDP-75.



Figure 18: selecting the VNC Server SDP-XX

The field **VNC server address** now shows the name "#VNC Server on SDP-XX", where XX is the number of the SDP-75.

Go to the field **VNC password** and enter the password, which is the **six-digit** serial number of the SDP-75:

- the password is **00000X**, if the number of the SDP-75's VNC Server has a single digit;
- the password is **0000XX** if the number of the SDP-75's VNC Server has 2 digits;
- the password is **000XXX** if the number of the SDP-75's VNC Server has 3 digits;
- etc...

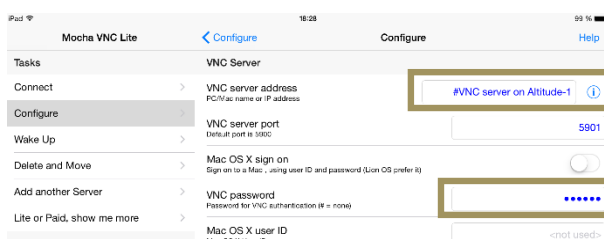

Figure 19: entering the password

The VNC Server is now configured.

Now click on the **Connect** menu item. The "#VNC Server on SDP-XX" should be listed in the page.

Select the line "#VNC Server on SDP-XX".

The graphic user interface of the SDP-75 should now be visible on the screen of your device.

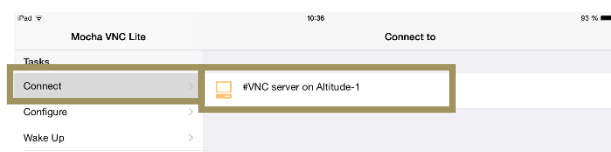

Figure 20: connecting to the SDP-75's VNC server

2.2.5 USING A MAC OS X COMPUTER WITH SCREEN SHARING

To connect to the SDP-75's VNC Server from your Mac OS X computer, you can use the integrated Screen Sharing VNC client included since OS X version 10.5 (Leopard):

1. Open the Finder application in your Mac OS X computer.
2. Select the item Go > Network in the Finder's menu. This will display the available VNC servers in your network.
3. Select (double-click) the server "VNC server on SDP-XX", where XX is the number of your SDP-75. This will display the following window;
4. Click on the Share Screen... button. This will display the Screen Sharing login panel;
5. Enter the password, which is the six-digit serial number of your SDP-75:
 - a. the password is **00000X**, if the number of your SDP-75's VNC Server has a single digit;
 - b. the password is **0000XX** if the number of your SDP-75's VNC Server has 2 digits;
 - c. the password is **000XXX** if the number of your SDP-75's VNC Server has 3 digits;
 - d. etc.
6. Click on the **Connect** button located in the lower left corner of the window.
7. The graphic user interface of your SDP-75 should now be visible on the screen of your Mac.

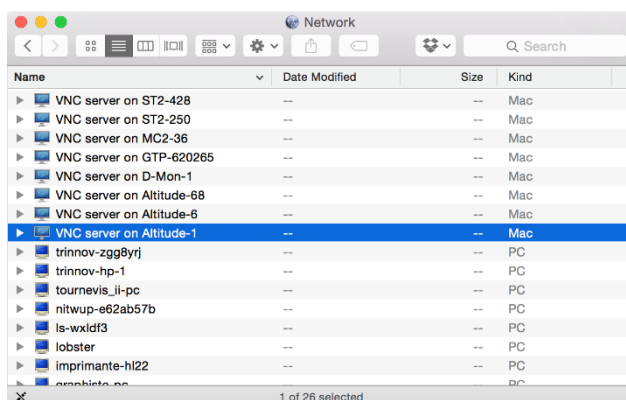
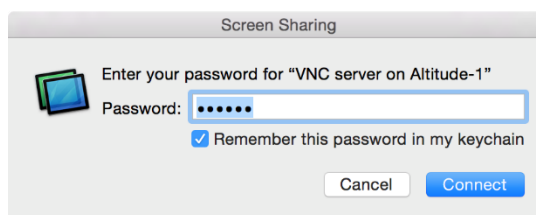
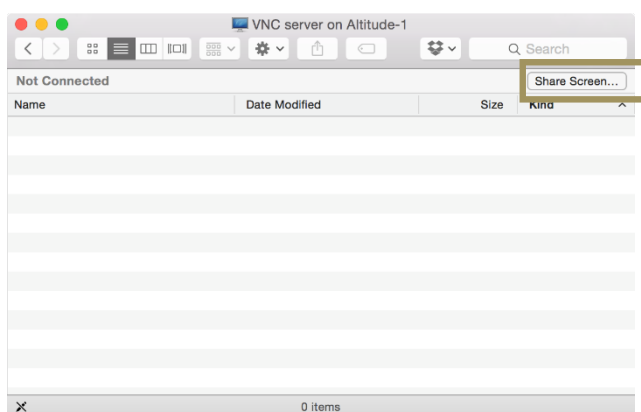

Figure 21: the Network page in Mac OS X's Finder



2.2.6 USING A MAC OS X COMPUTER WITH CHICKEN OF THE VNC

To connect to the SDP-75's VNC Server with the *Chicken of the VNC* client from a Mac OS X computer:

1. Open the **Chicken of the VNC** software in your Mac OS X computer.
2. The VNC Login window shows a list of available VNC servers. Select the server "**VNC server on SDP-75-XX**", where XX is the number of your SDP-75.

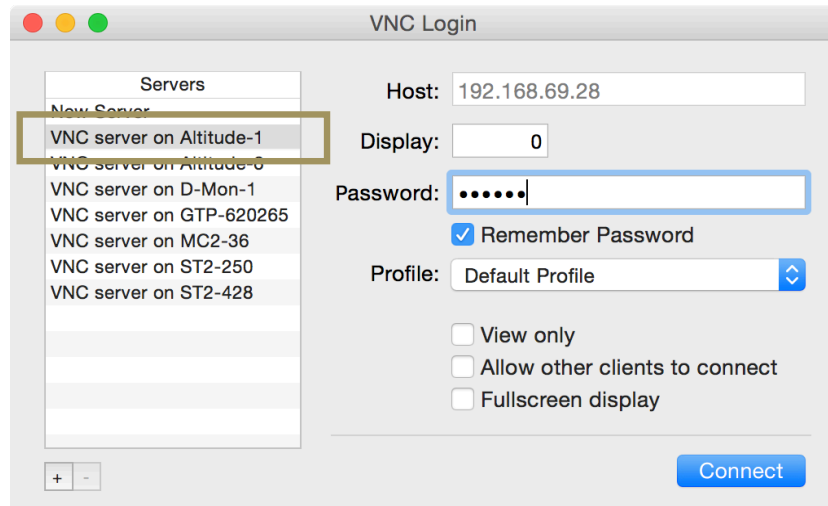

Figure 22: Chicken of the VNC Login window

3. The Host's IP address is automatically filled. You only need to enter the password, which is the **six-digit** serial number of your SDP-75:
 - the password is **00000X**, if the number of your SDP-75's VNC Server has a single digit;
 - the password is **0000XX** if the number of your SDP-75's VNC Server has 2 digits;
 - the password is **000XXX** if the number of your SDP-75's VNC Server has 3 digits;
 - etc...
4. Click on the **Connect** button located in the lower left corner of the window.
5. The graphical user interface of your SDP-75 should now be visible on the screen of your Mac.

2.2.7 USING A WINDOWS COMPUTER WITH TIGHT VNC

Since Tight VNC is not a zero-conf client, the connection procedure requires some additional steps, which are described below.

WRITE DOWN YOUR SDP-75'S SERIAL NUMBER

1. Go to your SDP-75's back panel to find out its serial number. The **6-digit serial number** is printed above the MADE IN FRANCE tag: it is "123456" in the example below:

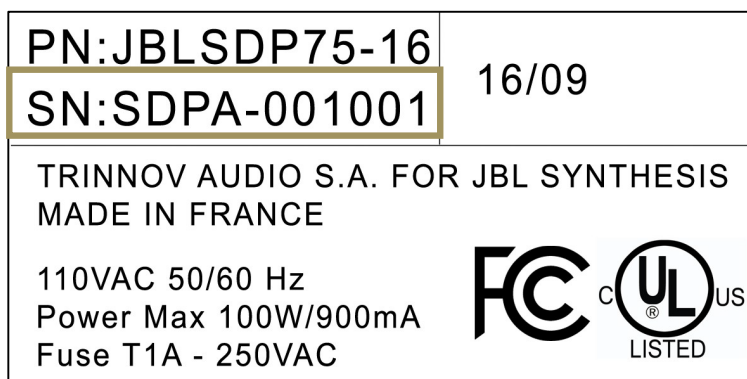

Figure 23: a serial number as printed on the back panel of the SDP-75

2. the VNC password is the **six-digit** serial number of your SDP-75:
 - The password is **00000X**, if the number of your SDP-75's VNC Server has a single digit;
 - The password is **0000XX** if the number of your SDP-75's VNC Server has 2 digits;
 - The password is **000XXX** if the number of your SDP-75's VNC Server has 3 digits;
 - Etc...

WRITE DOWN THE IP ADDRESS OF THE SDP-75

If your VNC client is not *zeroconf-enabled* it cannot find the SDP-75's VNC Server automatically. This is the case of the *Tight VNC* client for Windows. Therefore, you'll need to enter the SDP-75's **IP address** in the connection window. More precisely, the IP address you need to enter is:

- The **IP address of the Ethernet interface**, if the SDP-75 is connected to the router via an Ethernet cable.
- The **AP IP address** of the Wi-Fi interface, if the remote device is connected to the Access Point of the SDP-75.
- The **IP address of the Wi-Fi interface**, if the SDP-75 is connected to an existing Wi-Fi network.



NOTE:

the **IP address** of the SDP-75 can be retrieved:

- via the front panel, in the **Setup/Network/Ethernet** page or in the **Setup/Network/Wi-fi** page;
- from the **Network** page of the graphical user interface, displayed to a monitor via the VGA or DVI port.

GETTING THE IP ADDRESS FROM THE WI-FI SETTINGS

To get the IP address from the Wi-Fi settings via the front panel:

Click on the **menu** button

Go to the **Setup > Network > Wi-Fi** page:

Turn the Source/Item selection knob to scroll through the settings.

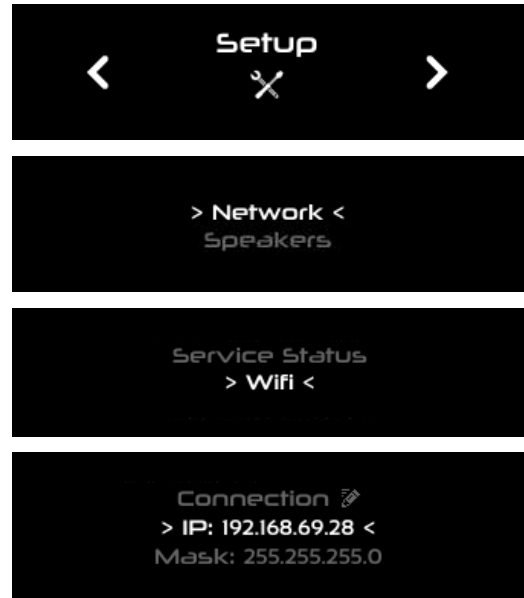

Figure 24: IP address in the Setup > Network > Wi-Fi page via the front panel

GETTING THE IP ADDRESS FROM THE ETHERNET SETTINGS

- To get the IP address from the Ethernet settings via the front panel:
- Click on the menu button
- Select the **Setup > Network > Ethernet** page
- Turn the **Source/Item selection knob** to scroll through the settings.

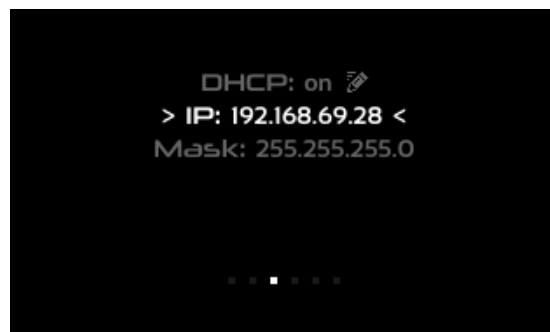

Figure 25: IP address in the Setup > Network > Ethernet page via the front panel

CONNECT WITH TIGHT VNC

First of all, use the SDP-75's front panel display to find out the **IP address** of its VNC Server (see the detailed explanation above).

To connect with your VNC client to the SDP-75:

1. Open the Tight VNC software in your Windows computer.
2. In the VNC client's connection window, enter the **IP address** of the SDP-75's VNC Server (see the detailed explanation above),
3. Click on the **Connect** button. This will open the **VNC Authentication** window:
4. In the **VNC Authentication** window, enter the password, which is the **six-digit serial number** of your SDP-75, printed on the back panel.
 - a. The password is **00000X**, if the number of your SDP-75's VNC Server has a single digit;
 - b. The password is **0000XX** if the number of your SDP-75's VNC Server has 2 digits;
 - c. The password is **000XXX** if the number of your SDP-75's VNC Server has 3 digits;
 - d. Etc...
5. Once you've entered the correct password, the SDP-75's graphical user interface will be displayed.

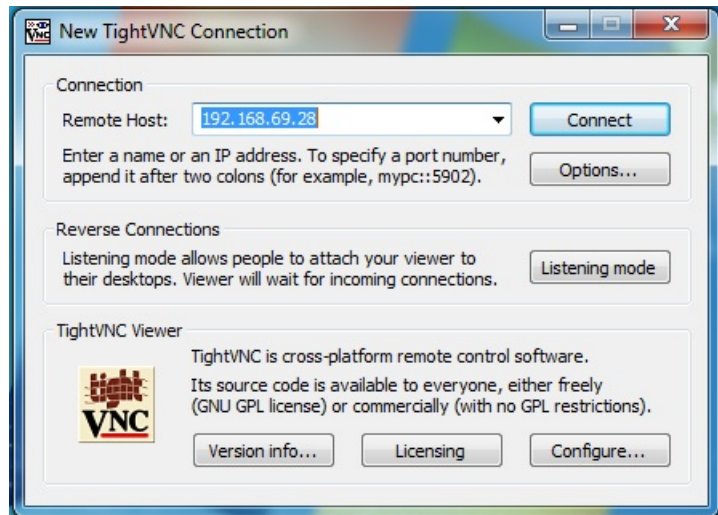
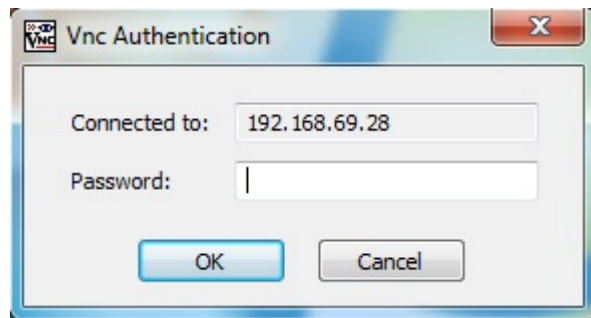

Figure 26: the New TightVNC Connection panel on a Windows computer



2.3 CHANGING THE NETWORK SETTINGS THROUGH THE FRONT PANEL

2.3.1 CHECKING THE WI-FI SETTINGS

To check the Wi-Fi settings via the front panel:

1. Click on the **menu** button
2. Go to the Setup > Network > Wifi page:
3. Turn the **Source/Item** selection knob to scroll through the settings.

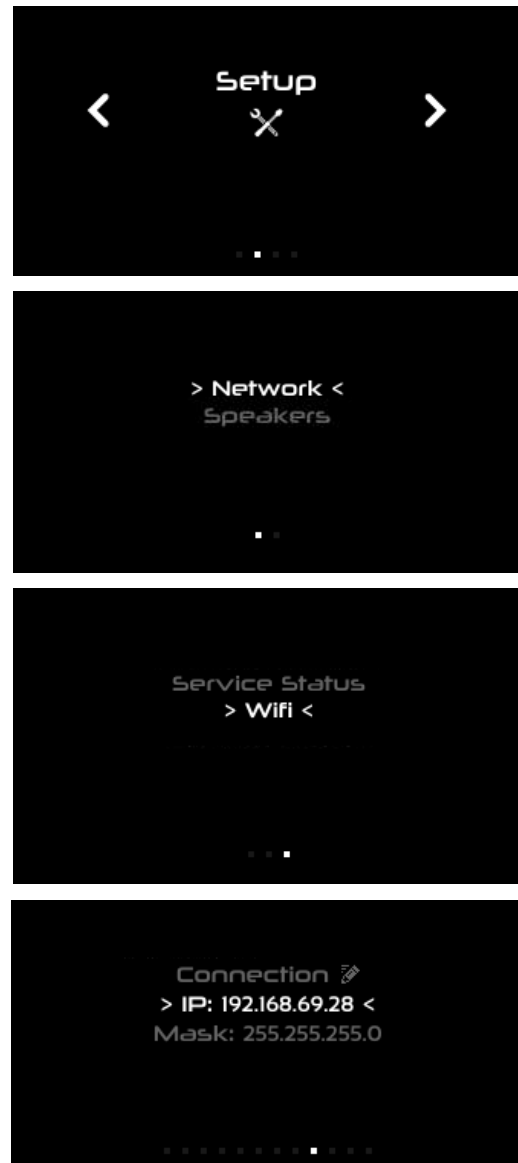

Figure 27:
Setup > Network > Wi-Fi page via the front panel

2.3.2 CHECKING THE ETHERNET SETTINGS

To check the Ethernet settings via the front panel:

1. Click on the menu button
2. Select the Setup > Network > Ethernet page
3. Turn the **Source/Item** selection knob to scroll through the settings.

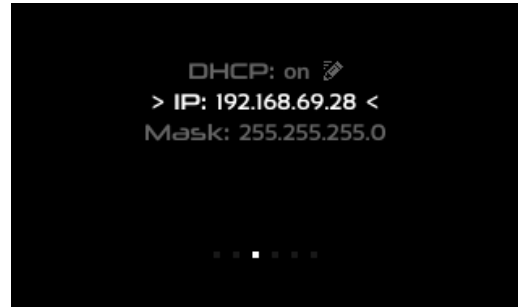

Figure 28:
Setup > Network > Ethernet page via the front panel

2.3.3 CONNECTING THE SDP-75 TO A WI-FI NETWORK

Please refer to Step 2 of the subchapter above.

2.4 CHANGING THE WI-FI SETTINGS THROUGH THE GUI

This subchapter explains how to change the Wi-Fi settings of the SDP-75 to meet the requirements of your home theatre's network environment.

2.4.1 ABOUT THE WI-FI INFORMATION

The following Wi-Fi information is available in the SDP-75:

- **Mode:** indicates the current Wi-Fi mode of the SDP-75.
- **AP SSID:** indicates the name of the SDP-75's Wi-Fi Access Point.
- **AP IP:** indicates the IP address of the Access Point to be used for VNC connection when using the SDP-75 as Wi-Fi Access Point.
- **AP password:** indicates the password to be used when attempting to join the SDP-75's Wi-Fi Access Point.
- **AP netmask:** indicates the netmask of the SDP-75's Wi-Fi Access Point.
- **Client status :** indicates the status of the Wi-Fi client of the SDP-75.
- **Client SSD:** indicates the name of the Wi-Fi Network joined by the SDP-75 as a Wi-Fi client. None displayed if no connection has been established.
- **IP address:** indicates the IP Address of the Wi-Fi client.
- **Netmask:** indicates the netmask of the Wi-Fi Network joined by the SDP-75 as a Wi-Fi client.

2.4.2 CHECKING THE WI-FI SETTINGS

The Wi-Fi network information can be retrieved from the Graphical User Interface of the SDP-75:

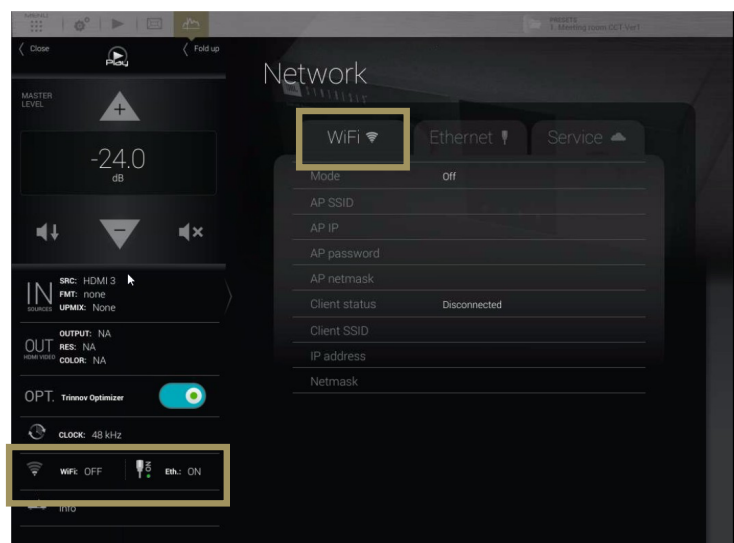

2.4.3 CONNECTING THE SDP-75 TO A WI-FI NETWORK

The most flexible network option for the final installation of your SDP-75 is to connect it as a Wi-Fi client to *your existing Wi-Fi network*. This will allow you to connect to the SDP-75 and to the Internet *simultaneously*, without switching back and forth between two different Wi-Fi networks.

To connect the SDP-75 to an existing Wi-Fi network:

- Open the **Advanced Settings** user interface.
- Go to the **Setup/Network** page.
- In the Wi-Fi section, click on the **Setup...** button. This opens the **Wi-Fi Status Modes** page.

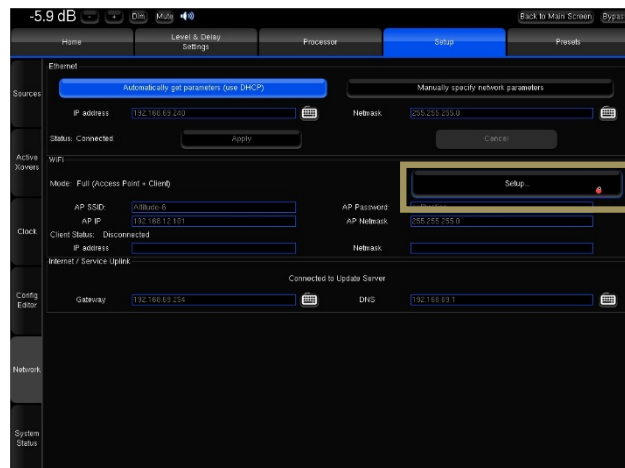

Figure 29: the Setup/Network page

- Click on the **Connect...** button in the bottom right corner of the page. This will display the available Wi-Fi networks. The **encryption** column displays a lock icon when the network is protected by a passphrase and/or encrypted. The **signal** column displays a Wi-Fi signal icon, indicating the strength of the Wi-Fi signal

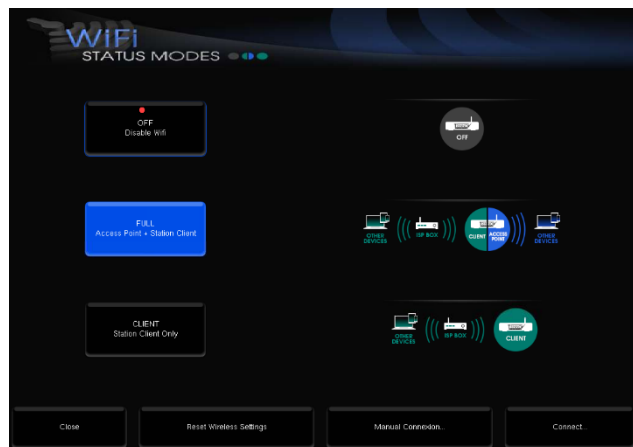

Figure 30: Wi-Fi status modes page

- Select the Wi-Fi network you want to join, and click on the **Connect** button. If you select an encrypted Access Point, you will be asked for the passphrase.
- Enter the passphrase and press the OK button.

Your SDP-75 should now be connected to the chosen Wi-Fi network.

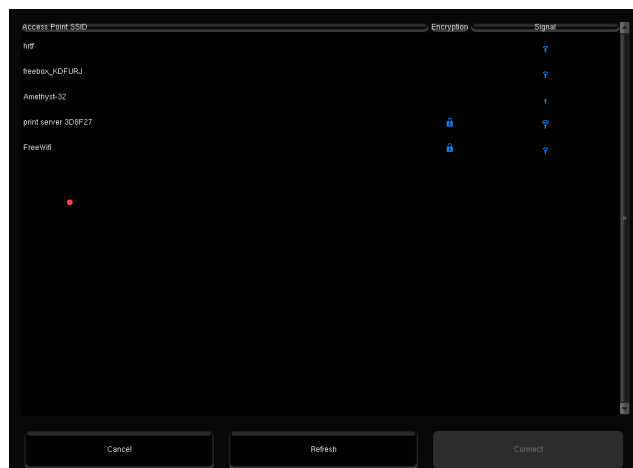
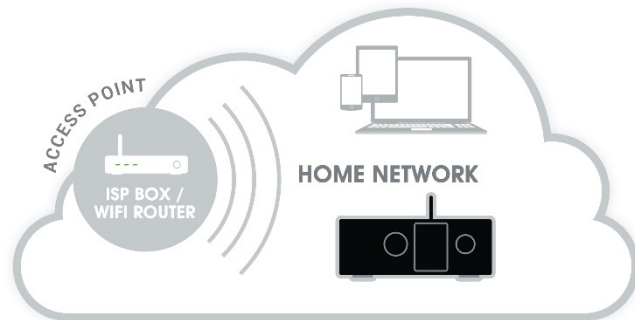

Figure 31: list of available Wi-Fi networks

2.4.4 CHANGING THE WI-FI STATUS MODE OF THE SDP-75

The SDP-75's built-in Wi-Fi and Ethernet modules allow it to **simultaneously** be part of a network as:

- An Ethernet client connected to an existing Ethernet network through an ISP Box (Internet Service Provider) or a router.
- A Wi-Fi Access Point (AP) to create its own Wi-Fi network.
- A Wi-Fi client to join an existing network wirelessly.



To change the Wi-Fi settings of your SDP-75 via the graphical user interface:

1. Open the **Advanced Settings** interface;
2. Go to the **Setup/Network** page;
3. Press the **Setup...** button to display the Wi-Fi Status Modes page:

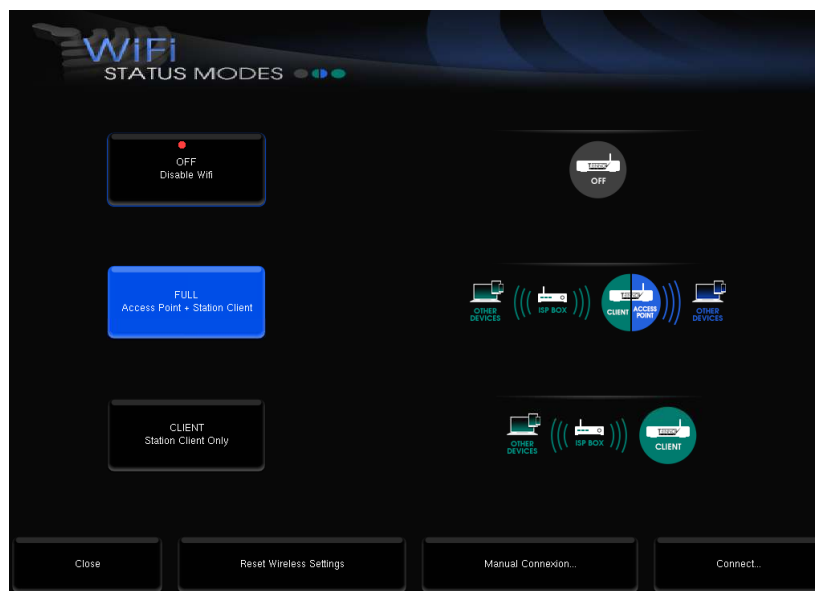

Figure 32: Wi-Fi Status modes

You can choose one of the following Wi-Fi modes:

- **OFF**: the Wi-Fi module of the SDP-75 is disabled.
- **FULL (default)**: the SDP-75 is used both as an Access Point and as a Client.
- **CLIENT**: the Access Point is disabled but the SDP-75 still operates as a Wi-Fi client as long as the configuration is valid.

2.5 CHANGING THE ETHERNET SETTINGS THROUGH THE GUI

This subchapter explains how to change the Ethernet settings of the SDP-75 to meet the requirements of your home theatre's technical environment.

2.5.1 ABOUT THE ETHERNET INFORMATION

The following Ethernet information is available in the SDP-75:

- **Status:** indicates the connection status of the Ethernet interface of the SDP-75
- **MAC address:** indicates the MAC address of the network interface of the SDP-75 (required to remotely switch the SDP-75 on with a Wake-on-Lan command).
- **IP address:** indicates the IP address of the Ethernet interface of the SDP-75.
- **Netmask:** indicates the netmask of the local area network joined as a DHCP client via Ethernet.
- **Gateway:** indicates the address of the Gateway for network interconnection.

2.5.2 CHECKING THE ETHERNET SETTINGS

The network information can be retrieved from the Graphical User Interface of the SDP-75:

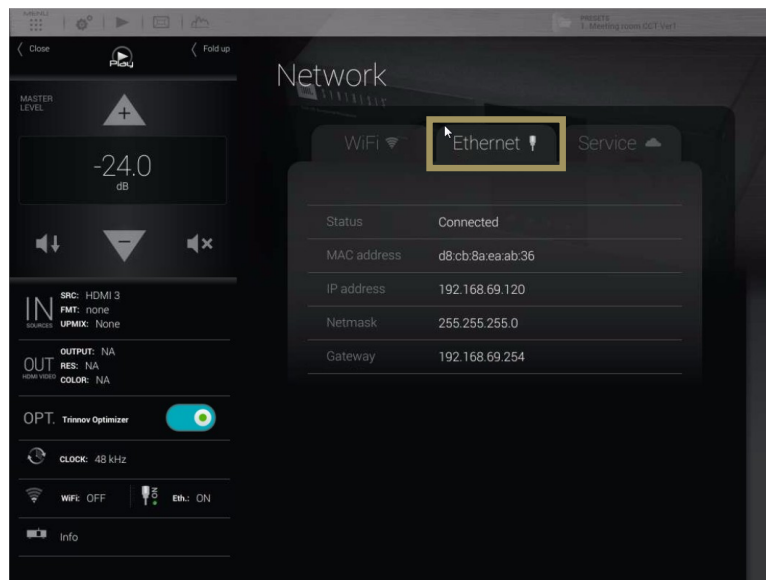

Figure 33: Ethernet Network Interface Information



NOTE: Network settings can only be changed through the **Advanced Settings interface** of the SDP-75. Go to the **Setup/Network** page to change the Ethernet and Wi-Fi settings.

2.5.3 CHANGING THE ETHERNET SETTINGS

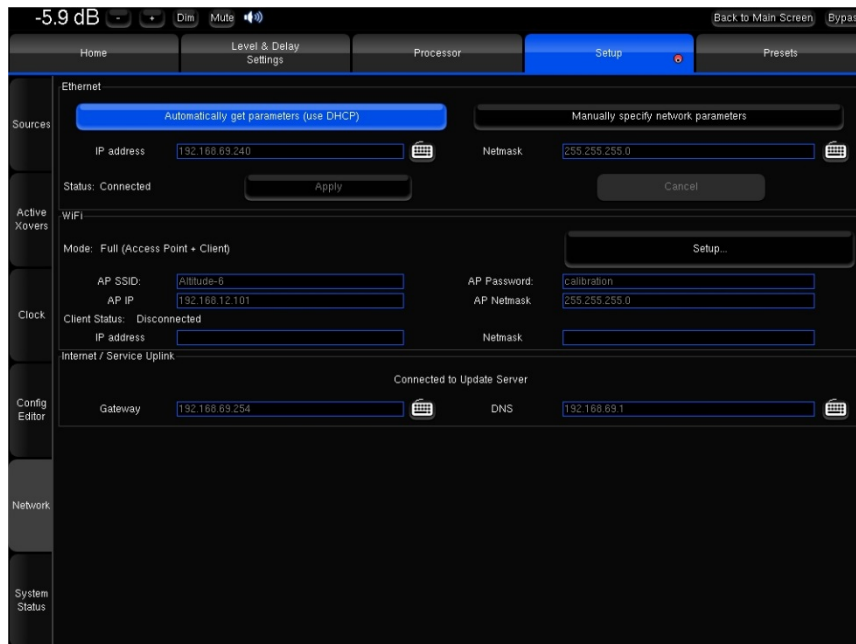
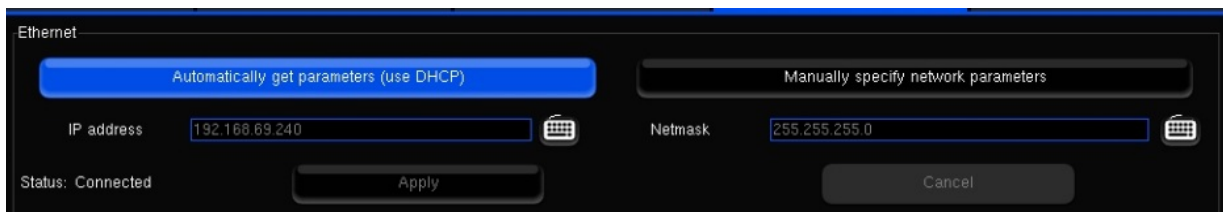

Figure 34: Network Setup in the Advanced Settings menu

The default mode of the Ethernet interface of the SDP-75 is DHCP, meaning that the SDP-75 will automatically be detected and configured by the router, provided that the router runs a DHCP server. This is the case in most domestic environments.

To configure the Ethernet connection manually, select the **Manually specify Network parameters** option and hit the **Apply** button.



The IP address, Netmask, Gateway and DNS option can then be edited manually.

Applying new settings with the **Apply** button is required for every change.



NOTE: It is recommended to refer to an IT specialist before switching to manual configuration.

2.6 ABOUT VNC AND ZERO-CONF NETWORKING

The SDP-75 leverages two important networking technologies: VNC and zero-configuration networking, which are explained below.

2.6.1 ABOUT VNC (VIRTUAL NETWORK COMPUTING)

VNC is a graphical desktop sharing system that transmits the keyboard and mouse events from one computer (server) to another (client), relaying the graphical screen updates back in the other direction, over a network.

The SDP-75 has a *built-in VNC Server* that allows you to access its graphical user interface over a network from any device running a *VNC client*.

In other words, you can control the SDP-75 from any device, whether it's a computer (PC, Mac or Linux) or a tablet (iOS, Android or Windows), provided that both the SDP-75 and your device are part of *the same network*.



NOTE: to learn more about VNC, please read the following article on Wikipedia:
http://en.wikipedia.org/wiki/Virtual_Network_Computing

2.6.2 ABOUT ZERO-CONFIGURATION NETWORKING

Zero configuration networking (zeroconf) is a networking technology that makes it easy to set up and use devices and services on a network. Because zeroconf-enabled devices indicate their availability, it's easy for you (or an app or service) to find devices and services that you want to use.

The SDP-75's *VNC Server* is zeroconf-enabled in order to indicate its availability to the zeroconf-enabled *VNC Client* running on your device (tablet or computer).

The two major implementations used in VNC client apps are:

- The *Bonjour* protocol, developed by Apple Inc. It is available in free VNC clients such as *Mocha VNC Light* (for iOS and Android devices) and *Chicken of the VNC* (for Mac OS X).
- *Avahi*, for the Linux operating system.

Microsoft has its own proprietary protocol for remote computing: RDP (Remote Desktop Protocol). This explains why there is no major implementation of the zeroconf technology on the Windows platform.



NOTE: to learn more about *Zero-configuration networking*, please read the following article on Wikipedia: http://en.wikipedia.org/wiki/Zero-configuration_networking

3 NETWORK STREAMING

3.1 THE UPNP PROTOCOL

The SDP-75 network streamer feature is based on the Universal Plug and Play (UPnP) set of networking protocols. In the UPnP/DLNA terminology, the SDP-75 is a UPnP Digital Media Rendering device and is used as secondary equipment to play media content sent through the network.

The SDP-75 must be used with DLNA/UPnP compatible server and controller devices. The Media Server shares its media library on the network with UPnP clients. The Media Controller is the primary device, used to automatically detect servers and play files on secondary devices as well as to control them.

Provided that the server supports these formats, the SDP-75 can decode and play high-resolution 24 bit/192 kHz WAV, AIFF, FLAC and 16 bit/192 kHz OGG music files.

3.2 UPNP NETWORK ARCHITECTURE

This architecture represents the most common and comfortable method to play media files in a domestic environment:

- A Network-Attached Storage (NAS) or a computer is used as UPnP server and shares the media library.
- The library is browsed from a Media Controller, installed on a tablet or smartphone.
- The SDP-75 is selected as rendering device from the Media Controller.



NOTE: Most NAS are UPnP compatible servers but any computer can be turned into a server provided that a compatible UPnP server software is installed.

Several applications can turn smartphone and tablets into media controllers or servers.

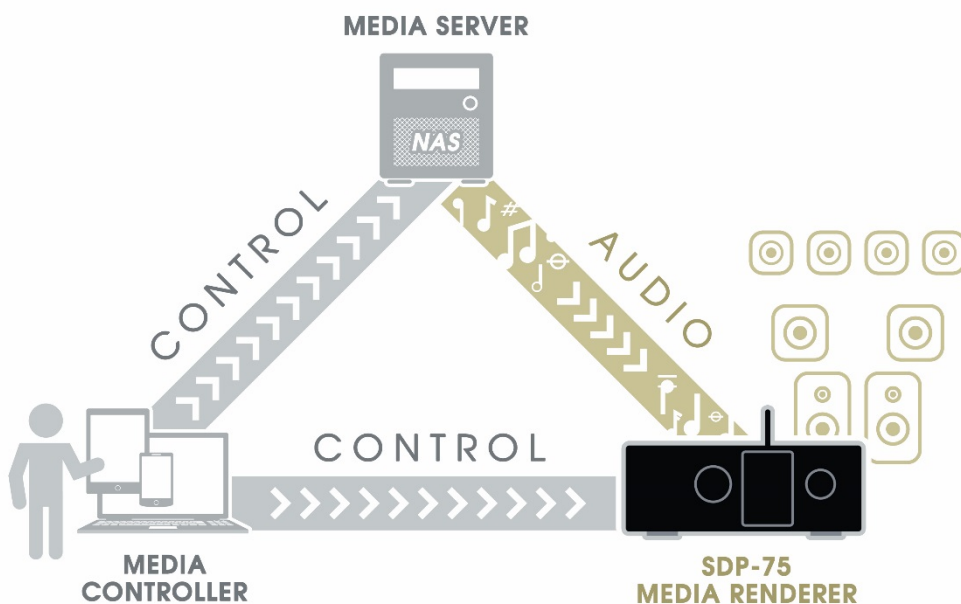

UPnP Network with a Digital Media Controller



UPnP Network with a device used as server and controller

3.3 RECOMMENDED UPNP SOFTWARE

"These software platforms have been selected, tested and qualified based on the following requirements.

JRiver
MediaCenter

PS Audio
eLyric Music Manager

These software has been selected, tested and qualified based on the following requirements.

- ✓ UPnP server and controller
- ✓ 24 bits 192 playback
- ✓ Bit Perfect Streaming
- ✓ WAVE AIFF FLAC OFF support
- ✓ Album cover art display
- ✓ User-friendly graphical user interface

JRiver

MediaCenter (www.jriver.com)

JRiver Media Center is a comprehensive media player and UPnP platform that can be used as both server and controller.

This software is therefore well-suited to the SDP-75.

JRiver Media Center is a commercial software available for PC and Mac.

DOWNLOAD > www.jriver.com/download.html



Server
&
Controller

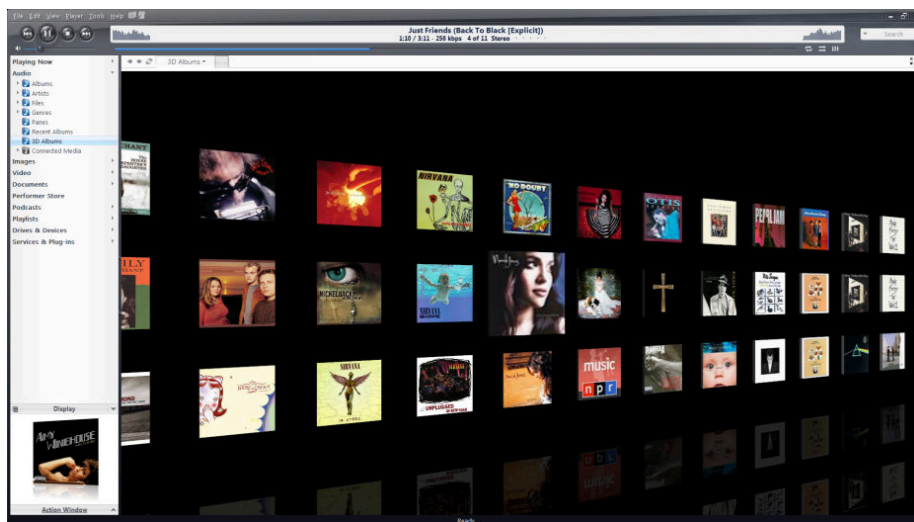

PS Audio

eLyric Music Manager (www.psaudio.com)

eLyric Music Manager is a free alternative media manager developed by PS Audio.

Also available for Windows® and Mac, it can be used as both UPnP server and controller.

DOWNLOAD > www.psaudio.com/products/audio/elyric-manager



Server
&
Controller

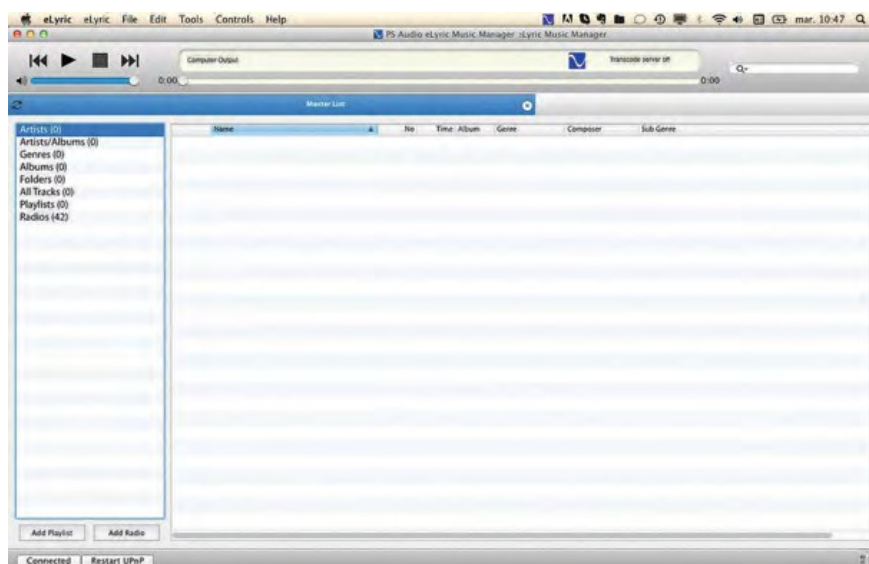

4 DAILY OPERATIONS

This chapter explains how to perform daily operations on the SDP-75 such as:

Volume control / Source selection / Preset selection...

These operations can be performed:

Via the front panel / Via the IR remote control / Via the graphical user interface.

4.1 AVAILABLE USER INTERFACES

Simple daily operations on the SDP-75 can be performed:

- On the front panel, by turning the Source/Item selection knob and pushing the Select button to scroll through the menus;
- With the infrared remote control,
- From your tablet or your computer, connected to the same network as the SDP-75:
 - with a *VNC Client* connected to the SDP-75's VNC Server,
 - with a *web browser* accessing the SDP-75's web-based interface,
- With a *display, a mouse and a keyboard* directly connected to the SDP-75's back panel.



NOTE:

- For a detailed step-by-step explanation of how to connect with a *VNC Client*, please see the subchapter ***First Network Connection to the*** SDP-75 in the ***Network Setup*** chapter.
- Further details about the *web interface* are provided in the ***Introduction*** chapter of this document.
- For additional details about connecting a *display, a mouse and a keyboard*, please refer to the ***Introduction*** chapter at the beginning of this document.

4.2 USING THE FRONT PANEL

4.2.1 POWER ON-OFF SEQUENCE



IMPORTANT NOTE: don't forget that the amplifiers should always be powered-on **last**.

Turn On the **main power switch on the rear panel** to supply the SDP-75 with power, then press the **front panel power button** to start the SDP-75.



NOTE: The system doesn't start instantly and takes about **60 seconds to complete its start-up**.

While the system starts, the front panel screen displays the following image:



Figure 35: Front panel startup image

To shut the SDP-75 down, press the front panel power button once. The front panel screen will then display the following image until a complete shutdown.



Figure 36: Front panel shut down image



NOTE: It is not recommended to cut the AC Power via the **main power switch on the rear panel**, as the system saves several "last-used" settings while shutting-down.

VOLUME CONTROL

Turning the **Volume Control knob** to the right or left will respectively turn the volume up or down.

Push the **Mute button** to mute all audio outputs of the SDP-75.

SOURCE SELECTION

There are two methods to select sources from the front-panel on the SDP-75:

- Turn the **source selection knob** to scroll through sources and push the select button.
- Use one of the **direct selection buttons** to choose among the first four sources (also available on the remote control).



NOTE: With factory settings, the last-used source is recalled on start-up.

PRESET SELECTION

In order to select a preset through the front-panel menus:

Push the **Menu** button, scroll until Presets and push the **Select** button.

Select the required preset using the **Source Selection Knob** and push the **Select** button.



4.2.2 CHECKING THE FORMAT OF INCOMING AUDIO

The format of the incoming audio of the currently selected source is displayed on the front panel display of the SDP-75 below the Optimizer status.

The Sampling Rate of the audio being played is indicated on the left side of the front panel display of the SDP-75.

The current up-mixer used is displayed on the front panel display on the SDP-75 below the sampling rate.



Figure 37: SDP-75 front panel display

4.3 USING THE IR REMOTE CONTROL

4.3.1 VOLUME CONTROL

The following volume control buttons are available on the IR Remote control

Volume Up
and Down
buttons

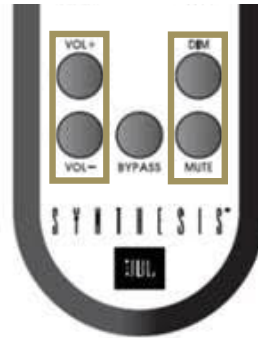

Dim and
Mute
buttons

4.3.2 SOURCE SELECTION

The IR remote control includes 4 buttons for direct source selection, as well as 2 buttons to browse through the sources

Direct Sources
selection
(instantaneous)



Browse through
Sources...

...and confirm with
'OK' button

4.3.3 LISTENING FORMAT SELECTION

These allows you to switch between the different listening format, and so between the different Up-mixers. This can be done on the fly, you do not need to press OK to validate.

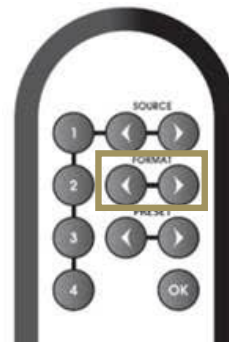

Switch among the
listening formats

4.3.4 PRESET SELECTION

To switch to another preset:

1. Browse through the presets with the **Preset arrow** buttons
2. Push the **OK** button.



Browse through Presets...

...and confirm with 'OK' button

4.3.5 ACCESS TO THE FRONT PANEL MENU

To access to the Menu :

1. Press on **Menu** button to access to the Menu
2. Browser with **< Left, > Right, ▲ up and ▼ down** arrows
3. Validate with the **OK** button
4. Return with the **Back** button

Access to the Menu...

...Browse with the arrows...



Return with Back Button

...Confirm with OK

4.3.6 LIGHT BUTTON

The **Light** button allows to turn off the front panel screen's backlight. Pressing on another button will temporarily turn on the backlight to let you know the settings you are changing. Pressing the **Light** button will turn the backlight on again.



Turn off or on the backlight

4.3.7 LEVEL AND DELAY ADJUSTMENT BYPASS

The **Bypass** button allows you to toggle on and off the Optimizer.



4.4 USING THE GRAPHICAL INTERFACE

4.4.1 VOLUME CONTROL

The following volume control options are available within the graphical user interface.



A **Mute** button also allows you to mute all audio outputs of the SDP-75.

A **Dim** button also allows you to decrease the volume by 20dB.



NOTE: By default the last used volume is recalled at start-up.

4.4.2 SOURCE SELECTION

Sources can be selected through the graphical user interface by clicking on the icon:

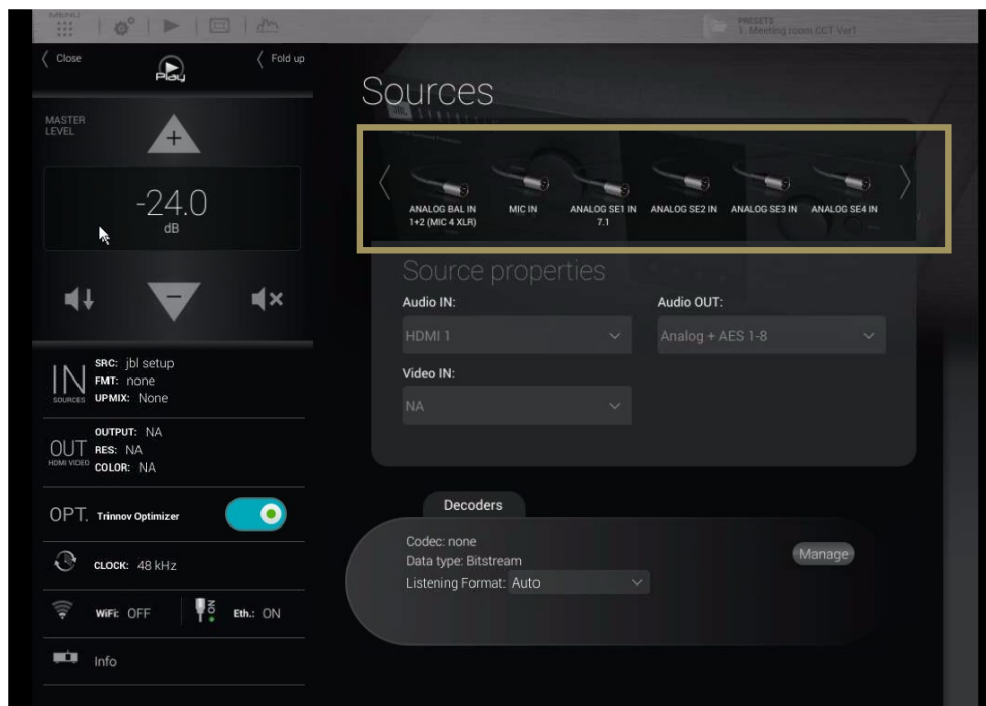
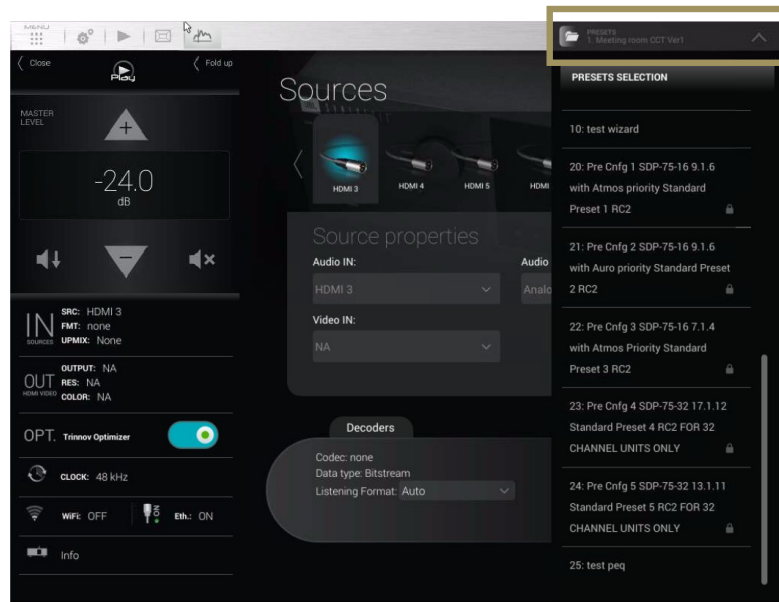

Figure 38: The source selection page in the graphical user interface

4.4.3 PRESET SELECTION

Presets can be selected through the graphical user interface:



The Presets button unfolds the presets menu

Click on a Preset to recall it

Figure 39: preset selection in the graphical user interface

4.4.4 CHECKING THE FORMAT OF INCOMING AUDIO

The format of incoming audio is displayed in the lateral menu bar and in the **Sources** page of the **Main** user interface:

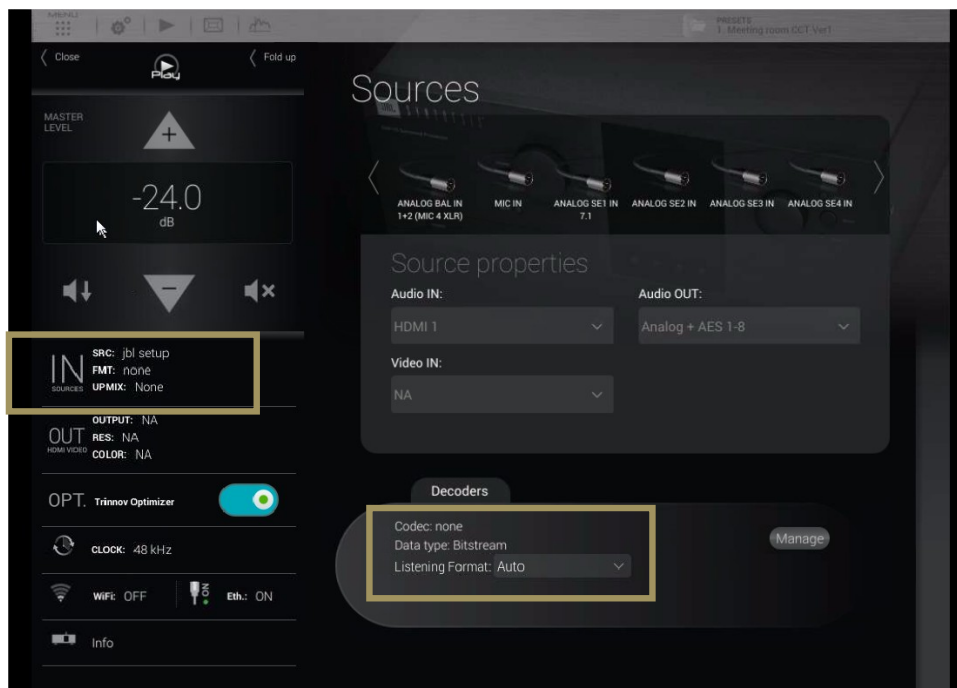

Figure 40: checking the audio format via the user interface

5 BASIC SETTINGS

5.1 NAMING YOUR SOURCES

The SDP-75 provides very flexible **Source Configurations**. Each **Source Configuration** can be renamed to reflect the actual source to which it corresponds. By default, the source names correspond to the names of the back panel connectors but can be edited in the **Home/Sources Config** page of the Advanced Settings Interface.

A **Source Configuration** can also include specific output and processing parameters. Therefore, it can be used to switch between outputs or between different processing settings. For example, it is possible to configure two **Source Configurations** set on the *same inputs* but set with *different names* to recall *different settings*.

The **Home/Source Config** page consists of one vertical tab per source on the left and source-specific parameters on the right.

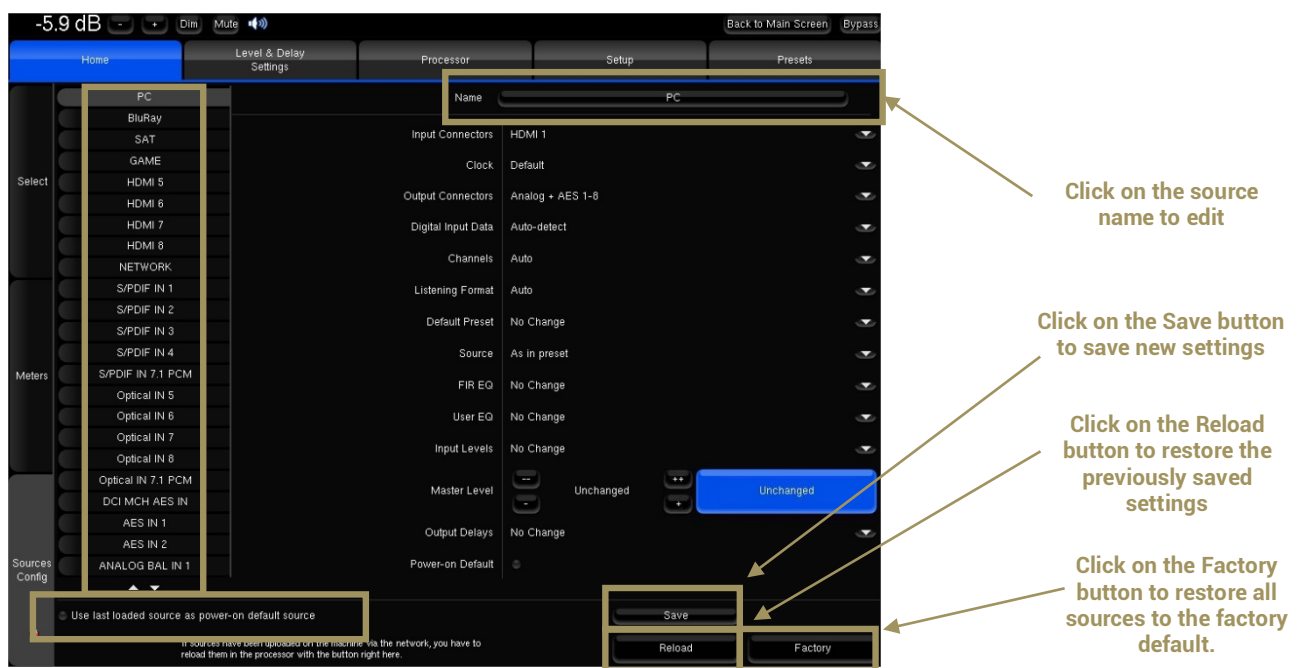
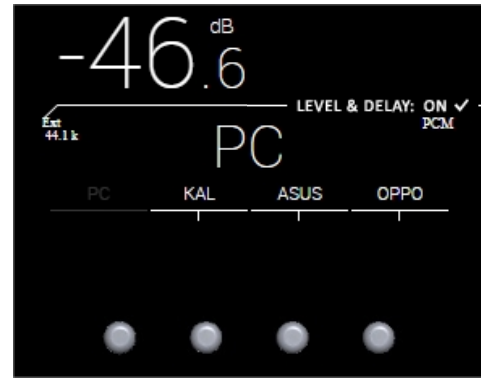

Figure 41: Source Configuration panel



IMPORTANT NOTE: It is particularly important to define user friendly names for the *first four sources* because they are displayed on the front panel screen, and can be recalled from the front panel or from the IR remote control source selection buttons.



IMPORTANT NOTE: Changes are not applied until saved via the **Save** button in the bottom right corner of the screen.

5.2 CONFIGURING YOUR SOURCES

In addition to an editable name, each **Source Configuration** includes several parameters to specify all the settings related to a specific configuration requirement for your system.

Source configurations can be used for different purposes:

- to switch between your different **sources**. For example: one Blu-ray player, one Network player and a Digital TV.
- to switch between different **outputs**. For example: a pair of 2.0-channel loudspeakers and a 5.1 home cinema setup.
- to switch between **sources and outputs simultaneously**. For example: play a vinyl record on the two-channel loudspeakers and a Blu-ray disc on the 5.1 home cinema system.
- to recall different **processing settings** such as acoustic optimization filters, decoding modes or bass management modes.

In order to change one of the parameters of the selected source configuration, click on the corresponding arrow:



Figure 42: Editing a source configuration

The following settings can be configured for each of your **Source Configurations**:

- **Input Connectors:** select the rear panel input(s) to which your source is connected.
 - Clock:
 - Default: the clock will run in primary mode for analog inputs, in secondary mode for digital inputs, and in primary mode for the network input.
 - Mast. Xk: set the clock to different primary clock sampling rates (32 kHz, 44.1 kHz, 48 kHz, 88.2 kHz or 96 kHz).
 - Sl. WC: set the clock to secondary mode.
- **Output Connectors:** select the outputs that you want to use to play this source:
 - Analog + AES 1-8: analog outputs 1-32 (depending upon your configuration) and AES outputs 1-8 are active simultaneously;
 - AES 1-16: AES outputs 1-16 are active; analog outputs are disabled;
 - AML: Audio Multi Link is active;
 - HDMI: HDMI outputs 1 & 2 are active simultaneously;
 - AES OLD 1-16: old routing used in the prerelease models. Do not use.
- **Digital Input Data:**
 - Auto-detect: automatically detect whether the input is PCM or bitstream;
 - Force PCM Audio: force the PCM audio format;
 - Force Bitstream Data: force the bitstream format to let the SDP-75 decode the signal from the player.
- **Channels:** On a non-HDMI source, you can select the channels you want to play.
 - L,R
 - L,R,C
 - L,R,C,Lfe
 - L,R,C,Lfe,Ls,Rs
 - L,R,C,Lfe,Ls,Rs,Lrs,Rrs
- **Listening Format:** Select the default format you want to use with this source. The SDP-75 will be forced to decode and up-mix (if possible) in this format.
 - Auto : Will automatically up-mix in the corresponding format
 - Dolby Surround : Will force the Dolby Surround up-mix
 - Neural:X : Will force the DTS Neural:X up-mix
 - Auro-3D: Will force the Auro-3D up-mix.
 - Native : keeps the incoming format from the source
 - Up-mix on native : Will automatically up-mix in the corresponding format with the Legacy layout
 - Legacy : Will only use the bed (5.1 or 7.1)
- **Default Preset:** This parameter allows you to link a source to one of the presets you created.
 - No Change: no preset is associated to this source configuration;
 - Select Preset number 1 to 29: Choose one of the 29 presets to load a preset when this source is selected.
- The following parameters are set, by default, to use the settings from the current preset:
 - Source (the format of the source)
 - **FIR EQ** : Select a FIR EQ that has been saved in the **Processor/Output** page.
 - **User EQ** : Select a FIR EQ that has been saved in the **Processor/Output** page.
 - Input Levels
 - Output Delays
- The **Master Level** can be left Unchanged (default setting) or set to a specific level.
- **Power-on Default:** the selected source can be set as the default configuration to be loaded at power-on. Alternatively, you can check the option **Use last loaded source as power-on default source** in order to keep the source that was used before the last shut-down.

5.3 DEFAULT SOURCE CONFIGURATION

When using the factory preset, the SDP-75 uses the last loaded source as power-on default source. This can be modified in the **Home/Sources Config** page of the Advanced Settings Interface:



Default Source

Select the vertical tab of the source you want to use as default source. Tick the **Power-on Default** checkbox. Press the **Save** button to apply the new parameter of the source.

5.4 LEVEL AND DELAY ALIGNMENT OPTIONS

The SDP-75's optimization of the system can be switched on/off via the Main interface.

To switch on/off the alignment options, click on the "OPT. Trinnov Optimizer" menu item of the lateral menu. The following alignment options are available in this page:

- To activate/deactivate *all of the Optimizer settings*:
 - The **Trinnov Optimizer** switch
- To activate/deactivate specific parts of the processing:
 - The **Acoustic correction** switch
 - The **Level alignment** switch
 - The **Delay alignment** switch



Figure 43: Optimizer Settings page

- **Trinnov Optimizer ON/OFF**: switch on/off the automatic correction of the in-room response: The acoustic correction, and the automatic delay and level alignment. When the Optimizer is **off**, only the manual settings related to the audio processor are applied:
 - Routing, as defined in **Speaker Configuration Table** in the **3D View** page of the Main interface;
 - The **Active Xovers** frequencies and filters;
 - Levels, as defined in the **Processor** pages of the Advanced interface;
 - Graphic EQs, as defined in the **Processor** pages of the Advanced interface;
 - Bass Management, as defined in the **Fine Tuning** page of the Main interface.
- **Acoustic Correction ON/OFF**: when turned **off**, both the automatic equalization (defined by the target curve) and the FIR EQs (defined in the **Processor/Outputs** page of the Advanced interface) are bypassed;
- **Level Alignment ON/OFF**: disable the automatic alignment of speaker levels, meaning that no automatic gain changes will be applied to the outputs;
- **Delay Alignment ON/OFF**: disable the automatic alignment of speaker distances, meaning that no automatic delays will be applied to the outputs.

5.5 NAMING, SAVING AND LOADING PRESETS

The SDP-75 can store up to 29 memory presets.
Presets can be managed in the **Presets** menu of the Advanced Settings Interface

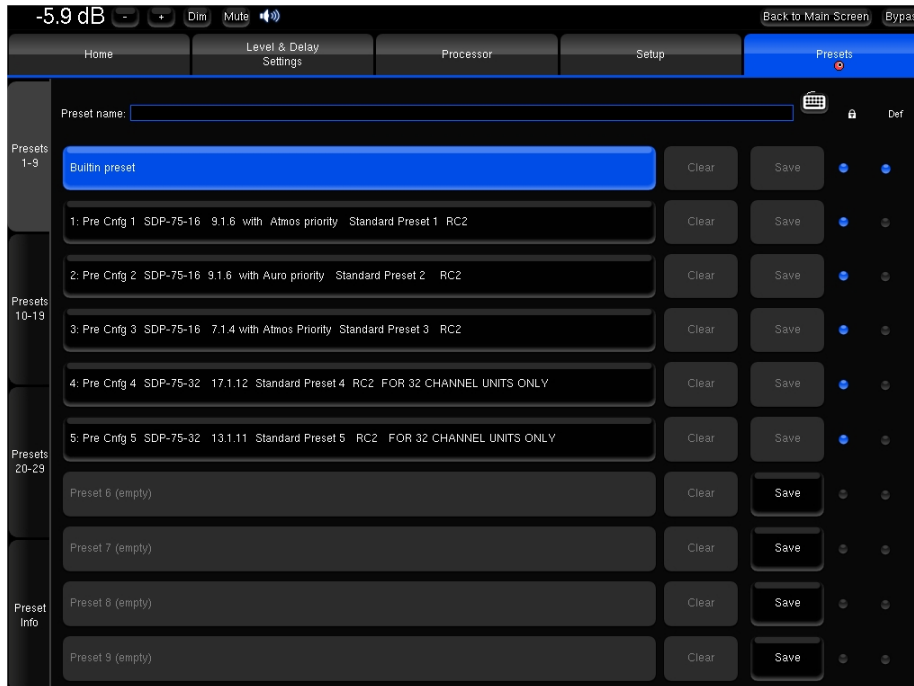

Figure 44: Presets 1-9 page

The most important parameters included in a preset are:

- The Optimizer adjustments, including acoustic correction, level and delay
- The settings of the manual filters
- The output configuration and routing

IMPORTANT NOTES:



- Except for sources settings, consider that everything is saved in a preset.
- Any parameter change will be lost if not saved in a preset.
- Please manipulate presets with care since overwriting a preset does not require confirmation.

The Presets page consists of four vertical tabs:

- Presets 1-9: includes the Built-in preset and presets 1 to 9
- Presets 10-19: includes presets 10 to 19
- Presets 20-29: includes presets 20 to 29
- Preset Info: shows the current preset information

Each Preset tab consist of the following items:

- The **Preset name** field: used to enter or modify a preset's name.
- 10 memory slots including from left to right:
 - The **Preset name/number**, greyed out when the slot is empty, highlighted in blue when the preset is selected.
 - A **Clear** button to clear the memory slot. This function irreversibly deletes the preset's parameters.

- A **Save** button to save current parameters as a preset in the memory slot.
- A **Lock** checkbox to protect the preset: disables the Clear & Save buttons.
- A **Def** (for default) checkbox to automatically load the preset as default after start-up.

As an example, the recommended procedure to duplicate a preset and copy it in a different memory slot would be to:

1. Reload the preset to recall the exact configuration you want to duplicate.
2. Use the Save button of an empty preset to copy it.



NOTES:

- The Built-in preset is locked and cannot be overwritten.
- A specific preset can be linked to each source. Please refer to the **Basic Settings chapter**.
- Presets can be backed-up and restored to/from a USB key. Please refer to the **Basic Settings chapter**.

5.6 DEFAULT PRESET

The default preset can be selected in the **Startup** option page of the product **information** menu:

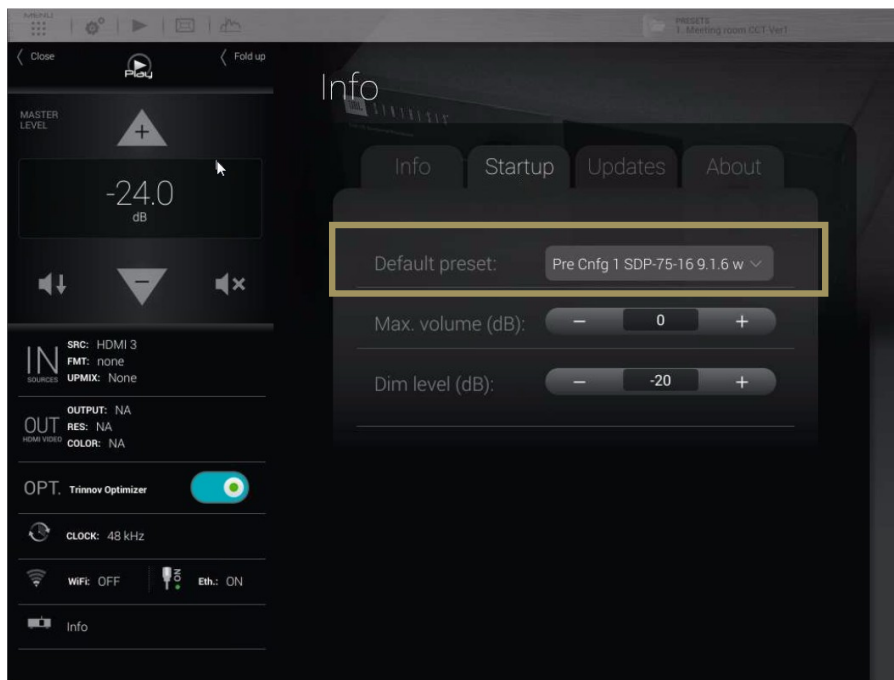

Figure 45: the Info/Startup page, default preset

5.7 SET A MAXIMUM VOLUME

The Maximum volume can be selected in the **Startup** option tab of the product **information** menu:

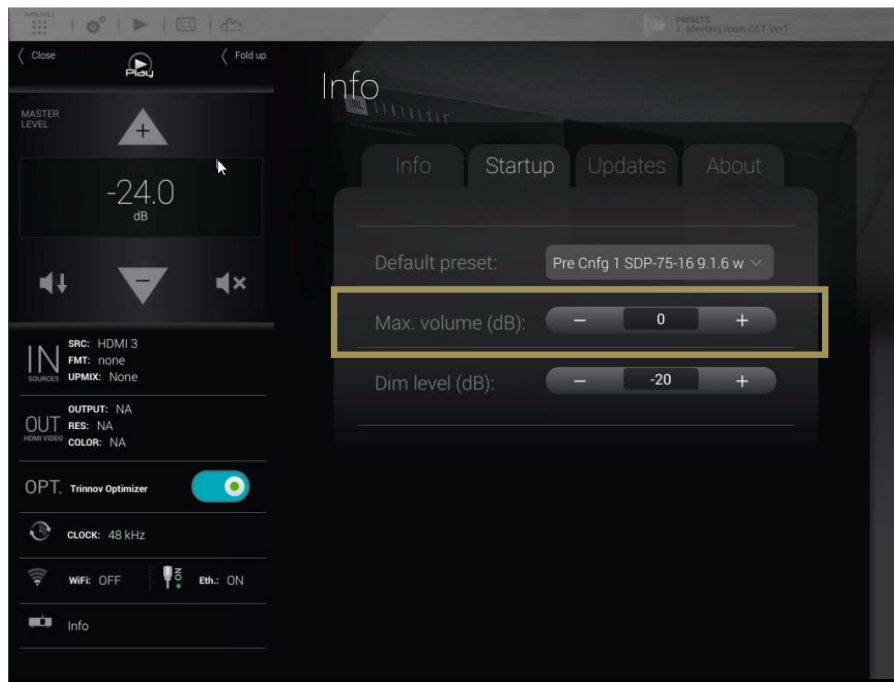

Figure 46: the Info/Startup page, maximum volume

5.8 SET THE DIM LEVEL

By default, the **Dim** is applying a -20dB on the master volume. The value can be change in the **Info** menu of the main page, **Setup** tab. Here, the parameter **Dim level (dB)** will define the amount of **Dim** to apply on the master volume when the **Dim** is engaged.

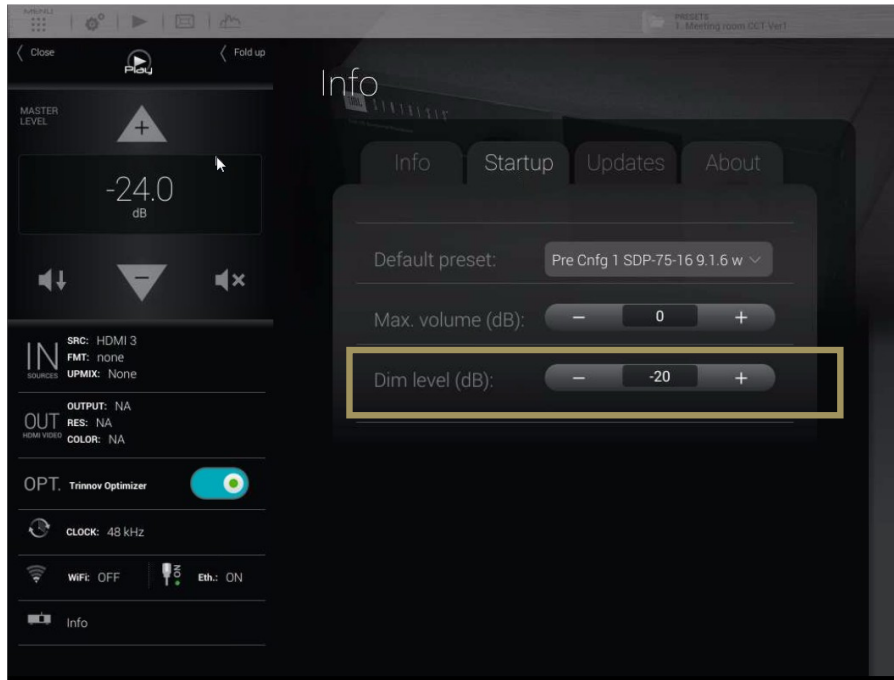

Figure 47: the Info/Startup page, Dim level

Backup/Restore of presets

5.9 BACKUP/RESTORE OF PRESETS



SDP-75 Rear panel - USB Ports

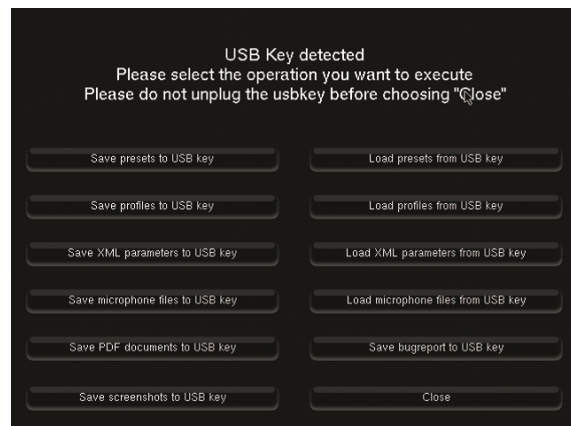

USB Pop-up menu

Several parameters can be saved, archived and restored using a USB key:

1. Insert a USB key in one of the USB Port located on the rear panel of the SDP-75.
2. As the USB Pop-up menu displays, select the operation you want to execute:
 - Save or Load **presets** to/from the USB Key
 - Save or Load **profiles (sources configurations)** to/from the USB Key
 - Save or Load **microphone compensation files** to/from the USB Key
 - Save a **Bug report** to the USB Key: when an expected error occurs, the system is halted to prevent damage to your system and a bug report is generated. After the restart of the SDP-75, you can save that bug report on the USB Key and send it to JBL Synthesis Support at csupport@harman.com.
 - Save **Screenshots** to the USB Key: you can take screenshots of the SDP-75's Graphical User Interface by pressing the "print screen" key of a keyboard connected to the SDP-75.



IMPORTANT NOTE: to ensure the data integrity of your USB Key, please press the **Close** button and wait until the USB Pop-up menu has disappeared to remove it.



NOTE: be careful when reloading presets from a USB Key: preset are identified by their memory slot. Therefore, a preset initially saved as preset number 5 would overwrite the preset number 5 stored on the SDP-75 without warning.

6 OVERVIEW OF THE SETUP PROCEDURE

The following summary provides an overview of the overall setup procedure that must be followed for a smooth and successful setup of the SDP-75 in a home theatre system.

A) Get ready for the installation

First of all, before you start, you must **carefully read** two key chapters that provide important information about the SDP-75 tools and settings, as well as very important tips and recommendations to perform the acoustical measurements:

1. Read the whole chapter about the SDP-75 **Essential Tools and Settings**;
2. Read the whole chapter **Getting Ready for Calibration** to get mandatory information on calibration procedure.

B) Perform the installation

Once you've learned the tools & tips, you are ready to follow the setup procedure:

Please note: it is critically important to follow the steps in the specified order, otherwise the system will not perform properly:

1. Specify the speaker layout in the SDP-75 graphic user interface: choose and configure the speaker layout. Send pink noise to verify that the routing of the speakers is correct.
2. *Optional:* if one or more speakers require multi-amplification: configure, calibrate and verify the SDP-75's intelligent active crossovers.
3. Fine-tune the speaker system in the room:
 - a. Measure all the speakers with the SDP-75's automated measurement and optimization tools;
 - b. *Optional:* if required, Setup Bass Management for multiple speakers;
4. Last but not least: verify the sound of the speaker system.

All these steps are explained in detail in the following chapters.



NOTE: the setup procedure of the SDP-75 can be performed:

- With a *VNC Client* connected to the SDP-75 through the network,
- With a display, a mouse and a keyboard directly connected to the SDP-75's back panel.

However, the setup procedure *cannot* be performed with a web browser connected to the SDP-75's web-based interface. Further details about the web interface are provided in the **Introduction chapter** at the beginning of this document.

For a detailed step-by-step explanation of how to connect with a *VNC Client*, please see corresponding pages in the **Network Setup chapter**. For additional details about connecting a display, a mouse and a keyboard, please refer to the **Introduction** chapter at the beginning of this document.

7 ESSENTIAL TOOLS AND SETTINGS

This chapter provides important information you need to know before you proceed with the setup procedure and the measurement process.

7.1 AUDIO CLOCK SETTINGS

At various times during the setup procedure, you may need to check the *status* of the audio clock or to manually change its *settings*

By default, the audio clock automatically switches to Secondary mode when you select a digital source, or to primary mode when you select an analog source. However, during the calibration procedure, you will select the microphone inputs, and you will later switch to an HDMI source to verify the sound of the system. At some point, the SDP-75 may be set to Secondary mode but may not be receiving any clock information if the digital source is not connected. In this situation, the system is not able to produce sound, like pink noise or sine waves. If this happens to you, please set the clock to primary mode, or simply switch to an analog input.

7.1.1 AUDIO CLOCK STATUS INFORMATION

The Word Clock page in the main window provides information about the status of the audio clock:

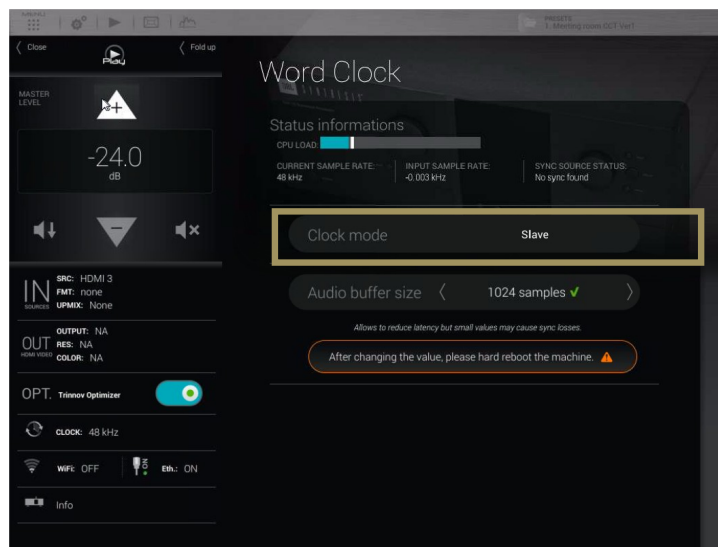

Figure 48: Audio clock status information

The information about the status of the audio clock includes:

- the clock mode: secondary or primary. This setting can be changed in the **Setup/Clock** page of the Advanced Settings interface (see below).
- the current sample rate: the sample rate currently used by the SDP-75. If the clock is in secondary mode it corresponds to the input sample rate. If the clock is in primary mode, it corresponds to the sample rate selected in the **Setup/Clock** page of the Advanced Settings interface.
- the input sample rate: the detected sample rate of the currently selected input.
- the current sync source: may be internal, if the clock mode is set to primary, or related to the currently selected source.

7.1.2 AUDIO CLOCK SETUP

Audio clock setup is available through the Advanced Settings interface of the SDP-75.

To access the clock settings page:

1. Click on the **Gears** button in the top menu to open the Advanced Settings user interface. 
2. Go to the **Setup/Clock** tab of the graphical user interface.

The **Clock** page of the **Setup** tab includes all the clock settings:

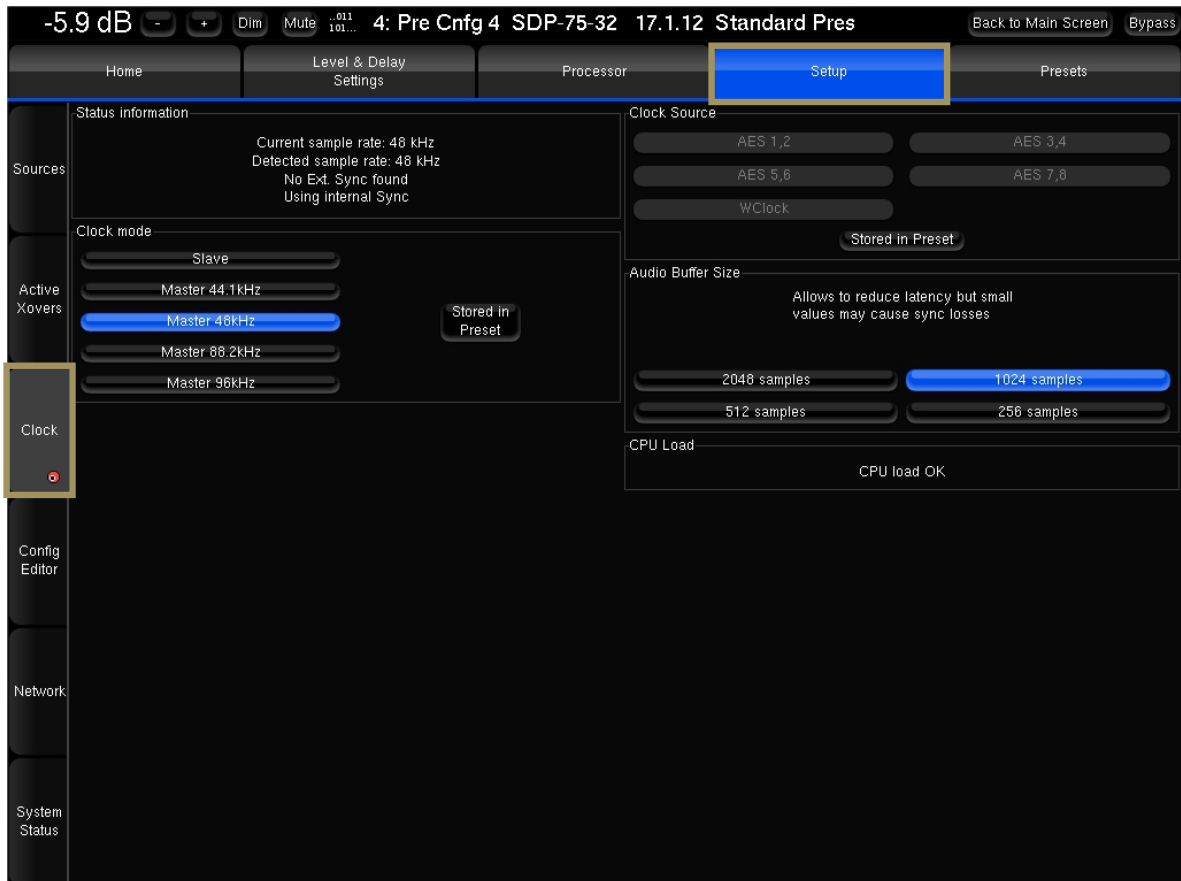

Figure 49: Clock settings page in the Advanced Settings

The **Setup/Clock** page includes:

- **Status Information:** the same information provided in the Clock page of the main user interface.
- **Clock Mode:** secondary or primary modes.
- **Clock Source:** one of the digital inputs or the internal Word Clock of the SDP-75.
- **Audio Buffer Size:** different buffer sizes, used to reduce latency. The buffer can be reduced to 512 samples to reduce audio latency, but this may cause sync problems. Only recommended for advanced users.



NOTE: Default buffer size is 1024 samples. It is recommended to keep this value to avoid any problems.

7.2 METERING THE INPUTS AND OUTPUTS

The SDP-75 includes an extensive set of audio tools to perform various tests and manual operations during the setup process.

To access the audio tools:

- Click on the **Gears** button in the top menu to open the Advanced Settings interface.
- Go to the **Processor** tab of the graphical user interface.



The main page of the Processor tab displays the input and output meters and a set of lateral tabs:

Input and Output levels can be monitored through the **Processor/Meters** page. Both the peak levels and the RMS levels are displayed:

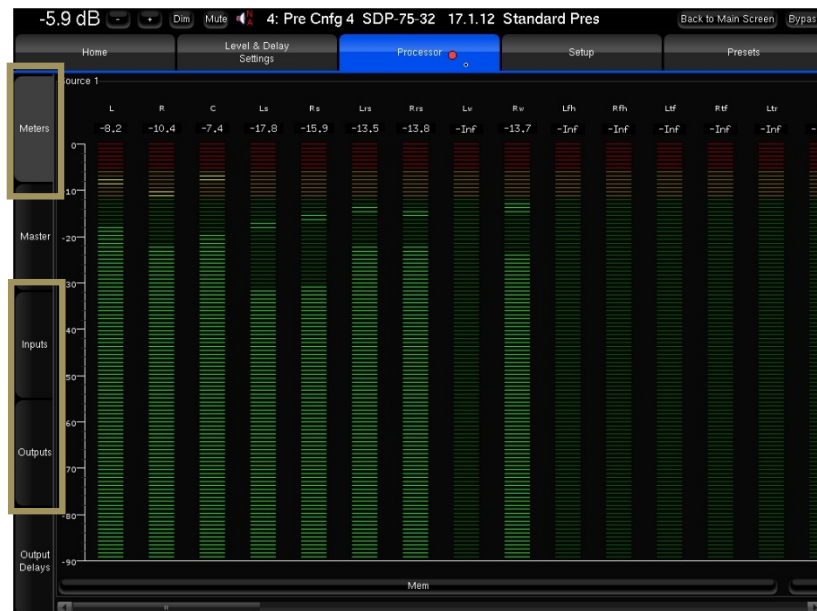

Figure 50: metering inputs and outputs

You can visualize the peak level of each channel. The highest level registered on each channel can be displayed by pressing the **Mem** button. When the level gets close enough to the saturation level, the name of the channel appears highlighted in red. The Clear button resets the memory and the saturation indicators for every channel of the group.



IMPORTANT NOTE: A digital signal cannot technically exceed 0 dBFS. Therefore, the red tag on top of each digital input channel only indicates when the maximum level of 0dBFS is reached and does not necessarily indicate distortion or clipping.

7.3 PLAYING PINK NOISE ON THE SPEAKERS

IMPORTANT NOTE: be careful about the *output level* before playing a test signal.



The Pink Noise generated from **Speakers/Room** setup tool is following the THX recommendations and is generated at -30dBFS

The sine wave and pink noise generated from **the Processor/Inputs** page are both generated at -20dBFS RMS.



NOTE: To be able to produce pink noise, the SDP-75 needs to have Word Clock synchronization. Be careful to use an analog source to be in primary clock, or that your digital device connected to the SDP-75 and selected is providing a clock signal.

Pink noise can be played:

- from the Speakers/Room setup tool
- in the Advanced Settings interface, from the **Processor/Inputs** page

To play a pink noise from the **Speakers/Room** setup tool, click on the **Pink Noise** button of the corresponding output channel:



Figure 51: playing Pink Noise from the Speakers/Room setup tool

The **Processor/Inputs** tab provides a complete set of processing options for each input channel. It allows you to send a 1000Hz sine wave or pink noise for every channel.

- To send a 1000Hz sine wave, click on the **Sine** button.
- To send pink noise, click on the **Pink Noise** button.

For instance, you can use Pink Noise for setting up your equalization as follows:

- In the **Processor/Inputs** page, press on the **Pink Noise** button for the channel you want to equalize,
- Switch to the **Processor/Outputs** page and open the **Preset EQ** or **User EQ** for that *same* channel,
- Make your EQ adjustments,
- Use the **Previous/Next** buttons: the *pink noise will follow* to the same channel.

7.4 SOLO/MUTE AN INPUT OR AN OUTPUT

The Inputs page and the Outputs page include **Mute** and **Solo** buttons that allow you to mute or solo any input or output channel at any time.

To Mute/Solo an input channel, go to the **Inputs** tab and click on the **Mute/Solo** button of the corresponding input channel:

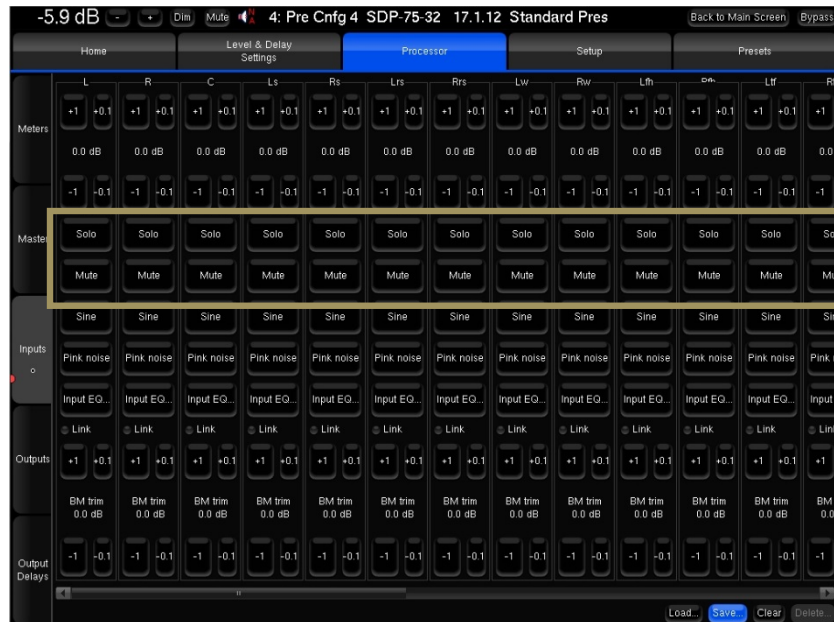

Figure 52: Mute and Solo buttons in the Inputs page of the Processor menu

7.5 SWITCHING ACOUSTICS CORRECTION AND LEVEL / DELAY ALIGNMENT ON/OFF

The SDP-75 offers two different ways to compare the sound of your system with or without all Optimization, or selectively Acoustics Correction, Level Alignment, and Delay Alignment:

- The **Bypass** button, which is always visible at the top right corner of the Advanced Settings user interface.
- The Optimization On / Optimization Off buttons in the Optimizer Settings/Runtime page.

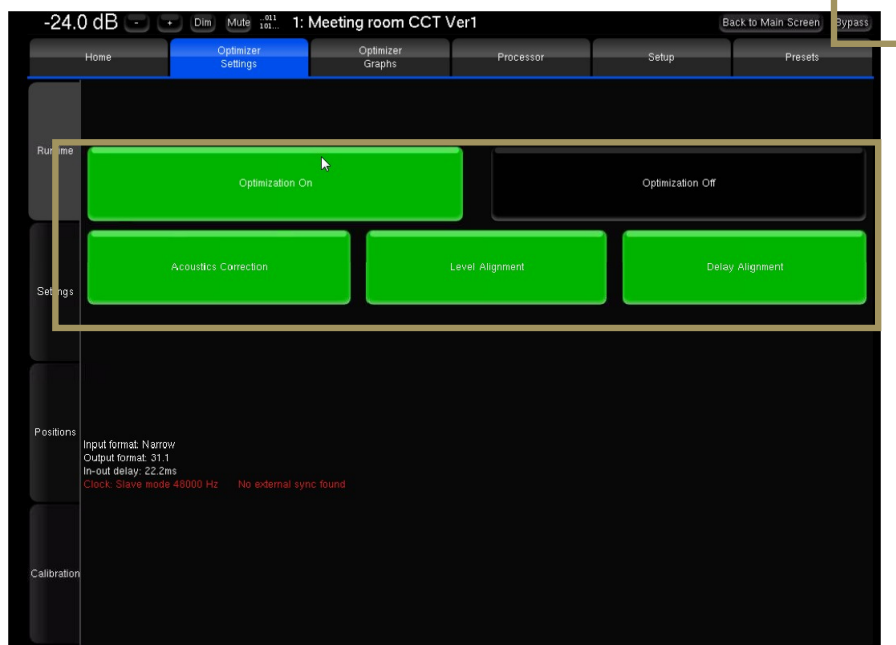

Figure 53: switching optimization on/off in the Advanced user interface

Optimization On/Off buttons: the buttons in the **Optimizer Settings/Runtime** page allow the user to selectively enable/disable the different corrections applied by the Optimizer.

These options are also available in the Main user interface in the Optimizer page.

Bypass button: the bypass button located at the top right corner of the graphical user interface is equivalent to the **Optimization Off** button



IMPORTANT NOTE: the **Optimization On/Off** and **Bypass** buttons disable the automatic compensation but manual correction is still applied :

- FIR and Graphic EQs
- Input and output gains
- Outputs delays
- Bass Management
- Active Xovers



Figure 54: switching the Optimization on/off in the Main user interface

7.6 VIEWING THE ACOUSTICAL GRAPHS

The SDP-75 is a complete and flexible tool for displaying the responses of the speakers *before* and *after* the Trinnov optimization, as well as the *correction filters*.

The acoustical graphs are available in the **Optimizer Graphs** page of the Advanced user interface. It is possible to display the acoustic responses of multiple speakers and analyze the information from various points of view: amplitude, phase, group delay, impulse response...



Figure 55: the acoustical graphs page

7.6.1 IMPORTANT NOTES

It is important to understand the information available on these graphs, as well as the information that is not available:

- The “after” graphs show the effects of the optimization parameters. These graphs are therefore based on calculations only, not on measurements. However, measurements with external test systems have always proved the accuracy of these calculations.
- These graphs only take into account the automatic filters computed according to the **Optimizer Settings** page, not the manual adjustments made in the **Processor** page.
- The display settings will be saved in preset.



7.6.2 GRAPHS DISPLAY OPTIONS

The **Optimizer Graphs** page consist of a Display area on the left, and a Config area on the right.

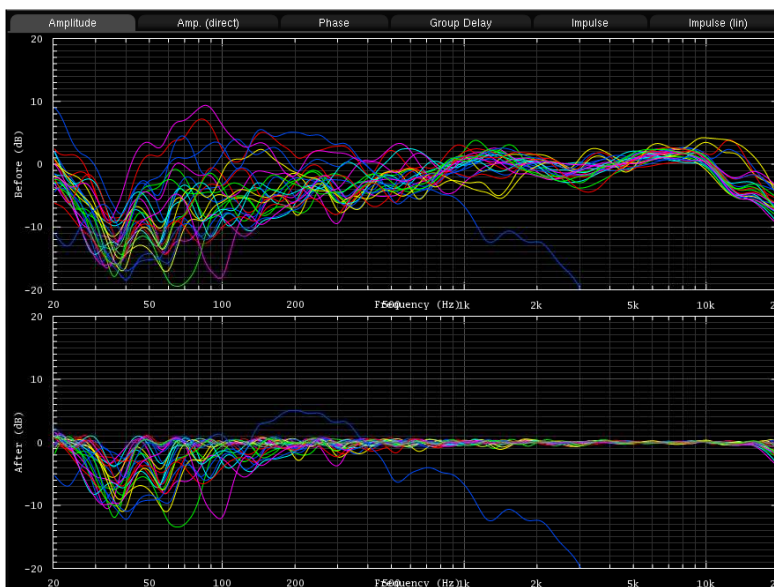

The Display area is organized in:

- Tabs & Sub-tabs
- Graphs
- Frames



The Configuration area is organized in:

- A Display tab
- A Settings tab

Zoom options allows modifying amplitude, frequency and time scales according to the type of representation.

7.6.3 CHOOSE DISPLAY OPTIONS ACCORDING TO YOUR REQUIREMENTS

This feature allows you to visualize on a same screen various type of data, which you can organize as you wish by a few parameters:

- The **Graphs Overlay**: type of data you want to overlay on a same graph (or **Frame**)
- The **Frames**: type of data displayed vertically on a same tab
- The type of data you want to visualize on each **tab** and **sub-tab**.



Figure 56: Comprehensive acoustical graphs

For each level, you can order the data through various criteria:

- The **speaker** (L, R, C, Sub, ...)
- The **point of measurement**: in the case of a multipoint configuration, you can visualize the response measured on each position, and the effect the optimization has on it
- The **type of response**: speaker response before optimization, speaker response after optimization, or filter response
- The **type of visualization**: amplitude, amplitude of the direct front and early reflections only, phase, group delay, or impulse response.

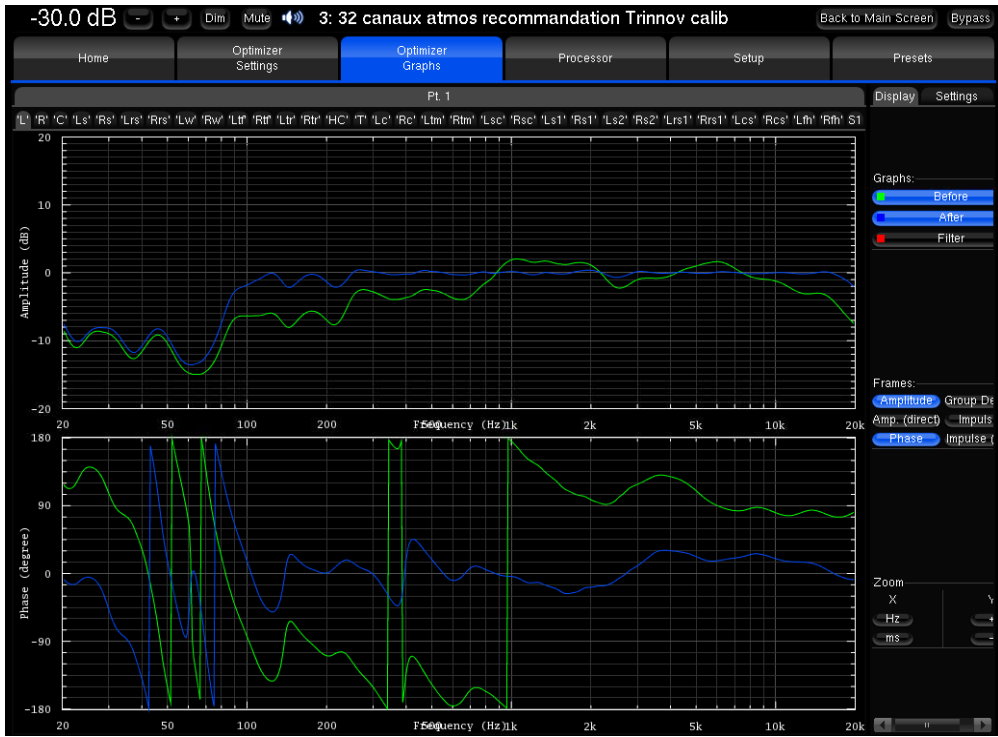

Figure 57: Focusing on specific graphs

8 SPECIFY THE SPEAKER LAYOUT

In this chapter we assume that a specific set of speakers have already been defined and installed in a room. In order to support multiple surround and 3D formats, we recommend relying on the expertise of a *Certified JBL Synthesis Installer*. They can design a speaker configuration that meets your requirements, and can also recommend optimal speaker placements according to your room's dimensions and acoustics.

For additional information about the Dolby, DTS and Auro-3D recommendations, please see the **Appendix** of this document and the related documents from Dolby, DTS and Auro.

8.1 OVERVIEW OF THE SPEAKERS SETUP PROCEDURE

The overall procedure to configure a speaker system is as follows:

- Select an **initial speaker layout** from one of the available templates;
- If necessary, **Add** or **Remove** speakers until your specific layout is defined;
- Configure the settings of each speaker, the channel mapping to Dolby, DTS, Dolby Atmos, DTS:X and Auro-3D formats, and the output routing;
- Verify the routing of the speakers by playing pink noise on each speaker;
- Set an array of speakers (please see next chapter)
- Save the preset.

Each of these steps is described in detail in the following pages.

8.2 INTRODUCING THE SPEAKER/ROOM SETUP TOOL

The SDP-75 provides a powerful tool to help you configure the speaker set of your home theatre system. The Speaker/Room setup tool provides the following features:

- a 3D model of your room that you can rotate and zoom in/out;
- a display of the 3D speaker positions in the room;
- a comprehensive set of surround and 3D speaker layouts so you do not need to start your speaker configuration from scratch;
- add or remove speakers (satellites and subwoofers);
- detailed configuration of each speaker, the channel mapping to Dolby, DTS, Dolby Atmos, DTS:X and Auro-3D formats, and the output routing;
- An easy way to set up speakers arrays;
- a pink noise button to easily verify the routing of the speakers.



IMPORTANT NOTE: it is important to understand that, because the SDP-75's automated process measures **all the speakers** (including the subwoofers) during each measurement. You must create in the SDP-75's user interface a speaker configuration that includes **all the speakers** of your installation (including the subwoofers).

The **Speaker Configuration** page can be accessed through the Top Menu of the SDP-75's graphic user interface, highlighted below.

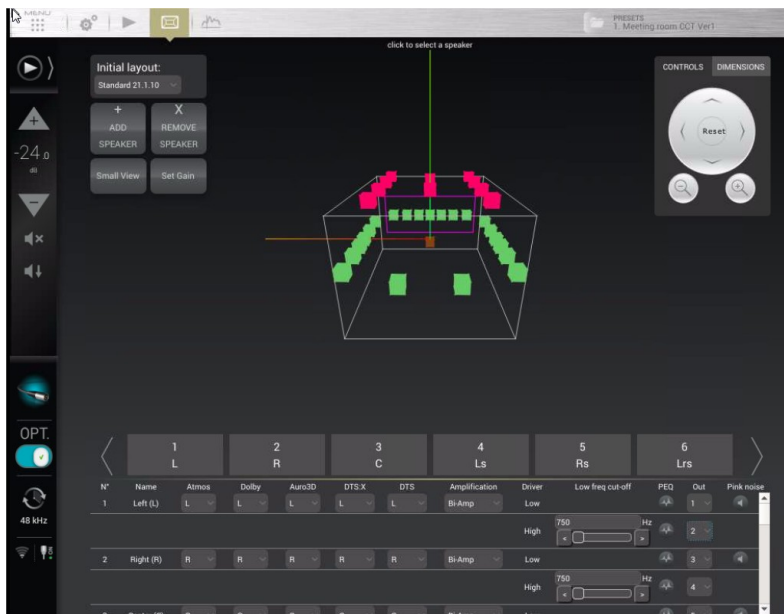
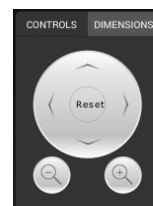

Figure 58: The Speaker/Room setup tool



The **Controls** box located in the top right corner of the window allows you to navigate through the 3D view. You can rotate the view, zoom in and zoom out.



The **Dimensions** tab allows you to set your room dimensions and screen size.



NOTE: The room visualization is simply a representation showing the theoretical speaker placement of the selected layout. It is not taken into account for the acoustic optimization and does not affect the sonic performance of the system. The position of a speaker is not critical but its label will determine which decoded channel it will reproduce.

8.3 AN EXAMPLE OF A SPECIFIC SPEAKER LAYOUT

The SDP-75 is designed to support any speaker layout. This includes standard speaker layouts such as those specified by Dolby, DTS and Auro-3D, but also hybrid speaker layouts based on two or more speaker placement recommendations. This allows your installation to support the different surround and 3D formats currently available in DVD, Blu-ray, UHD Discs, streaming media, and file-based media.

Below is an example of a specific speaker layout designed to support multiple formats:

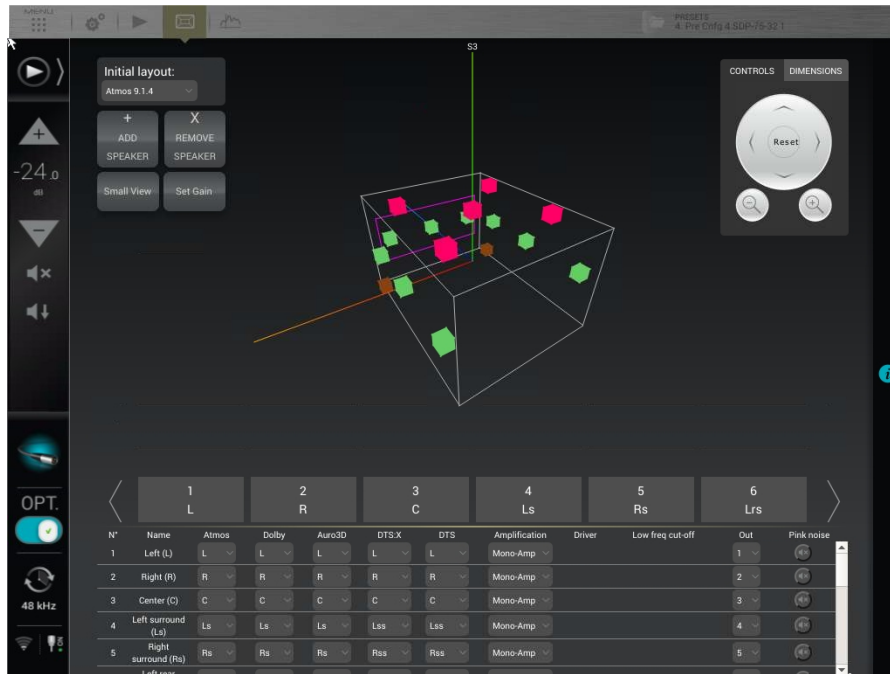

Figure 59: Example of a specific configuration with 16 speakers

This configuration of 16 speakers includes:

- initial layout (7 full-range speakers + 1 subwoofer)
- 6 additional speakers based on the Dolby Atmos format:
- 2 additional Lw & Rw speakers (Left wide & Right wide)
- 4 additional height speakers: Ltf & Rtf (Left & Right top front) and Ltr & Rtr (Left & Right top rear)
- additional ceiling speaker for the Auro-3D Top channel ("Voice of God").
- 1 extra subwoofer.

The following pages describe how to setup such a configuration.

8.4 AVAILABLE INITIAL LAYOUTS

The following layout templates are available to start your setup process with an initial layout as similar as possible to your specific configuration.

 NOTE: For detailed information about speaker recommendations, please refer to the appendix of this document and to the related Dolby, DTS and Auro-3D recommendations.	
STEREO AND SURROUND LAYOUTS	DOLBY ATMOS LAYOUTS
<ul style="list-style-type: none"> • Stereo 2.0 (L/R) • 5.1 (L/R/C/LFE/Ls/Rs) • 7.1 (L/R/C/LFE/Ls/Rs/Lrs/Rrs) 	<ul style="list-style-type: none"> • Dolby Atmos - 5.1.2 (5.1 + Ltm/Rtm) • Dolby Atmos - 5.1.4 (5.1 + Ltf/Rtf + Ltr/Rtr) • Dolby Atmos - 7.1.2 (7.1 + Ltm/Rtm) • Dolby Atmos - 7.1.4 (7.1 + Ltf/Rtf + Ltr/Rtr) • Dolby Atmos - 9.1.2 (7.1 + Lw/Rw + Ltm/Trm) • Dolby Atmos - 9.1.4 (7.1 + Lw/Rw + Ltf/Rtf + Ltr/Rtr)
AURO-3D LAYOUTS	DTS:X LAYOUTS
<ul style="list-style-type: none"> • Auro-3D - 9.1 (5.1 + HL/HR + HLs/HRs) • Auro-3D - 10.1 (5.1 + HL/HR + HLs/HRs + T) • Auro-3D - 11.1 (5.1 + HL/HR + HC + HLs/HRs + T) • Auro-3D - 11.1 (7+4) (7.1 + HL/HR + HLs/HRs) • Auro-3D - 13.1 (7.1 + HL/HR + HC + HLs/HRs + T) 	<ul style="list-style-type: none"> • DTS:X - 5.1.2 (5.1 + Lh/Rh) • DTS:X - 5.1.4 (5.1 + Lh/Rh + Lhr/Rhr) • DTS:X - 7.1.2 (7.1 + Lh/Rh) • DTS:X - 7.1.4 Heights (7.1 + Lh/Rh + Lhr/Rhr) • DTS:X - 7.1.4 Tops (7.1 + Ltf/Rtf + Ltr/Rtr)
STANDARD LAYOUT	
<p>In addition to the Dolby, DTS and Auro3D templates, the SDP-75 includes a set of standard layouts. These layouts are based on a 7.1 surround layout with additional speakers to support multiple surround and 3D formats such as Dolby Atmos, DTS:X and Auro-3D.</p> <p>Note that this layout can be modified to support the largest Dolby Atmos configuration.</p> <ul style="list-style-type: none"> • The 16 speaker layout : Standard 9.1.6 (7.1 + Lw/Rw + Ltf/Rtf + Ltr/Rtr + Hc + T) <ul style="list-style-type: none"> • 8 speakers (7 full-range speakers + 1 subwoofer) for the 7.1 surround layout • 6 speakers based on the Dolby Atmos format: <ul style="list-style-type: none"> • 2 additional surround speakers: Lw & Rw (Left wide & Right wide) • 4 additional height speakers: Ltf & Rtf (Left & Right top front) and Ltr & Rtr (Left & Right top rear) • 1 additional center height speaker for the Center Top Front channel: HC (Auro-3D) or Ch (DTS:X) • 1 additional ceiling speaker for the Top channel: T (Auro-3D) or Oh (DTS:X). • The 20 speakers layout : Standard 11.1.8 (7.1 + Lw/Rw + Ltf/Rtf + Ltr/Rtr + Hc + T + Ltm/Rtm + Lc/Rc) <ul style="list-style-type: none"> • based on the 9.1.6 layout • 2 additional Top Middle channels : Ltm/Rtm used by Dolby Atmos and DTS:X formats • 2 additional speakers behind the screen: Lc/Rc used by Dolby Atmos and DTS:X formats. • The 32 speakers layout : Standard 21.1.10 (7.1 + Lw/Rw + Ltf/Rtf + Ltr/Rtr + Hc + T + Ltm/Rtm + Lc/Rc + Lsc/Rsc + Ls1/Rs1 + Ls2/Rs2 + Lrs1/Rrs1 + Lcs/Rcs) <ul style="list-style-type: none"> • based on the 11.1.8 layout • 2 additional speakers behind the screen : Lsc/Rsc used by the Dolby Atmos format • 4 additional surround speakers : Ls1/Rs1 and Ls2/Rs2 used by Dolby Atmos and DTS:X formats • 2 addition rear surround speakers Lrs1/Rrs1 used by the Dolby Atmos format • 2 additional center surround speakers: Lcs/Rcs used by the Dolby Atmos format. 	

8.5 SELECT AN INITIAL SPEAKER LAYOUT

We recommend you to start by selecting the initial layout which is most similar to your specific speaker layout, and then add/remove speakers. Alternatively, you could also create a speaker configuration from scratch.

To select an initial speaker layout:

- Go to the **Speaker/Room setup** tool and click on the **Initial Layout** drop-down list
- Select the layout template which is most similar to your speaker system.

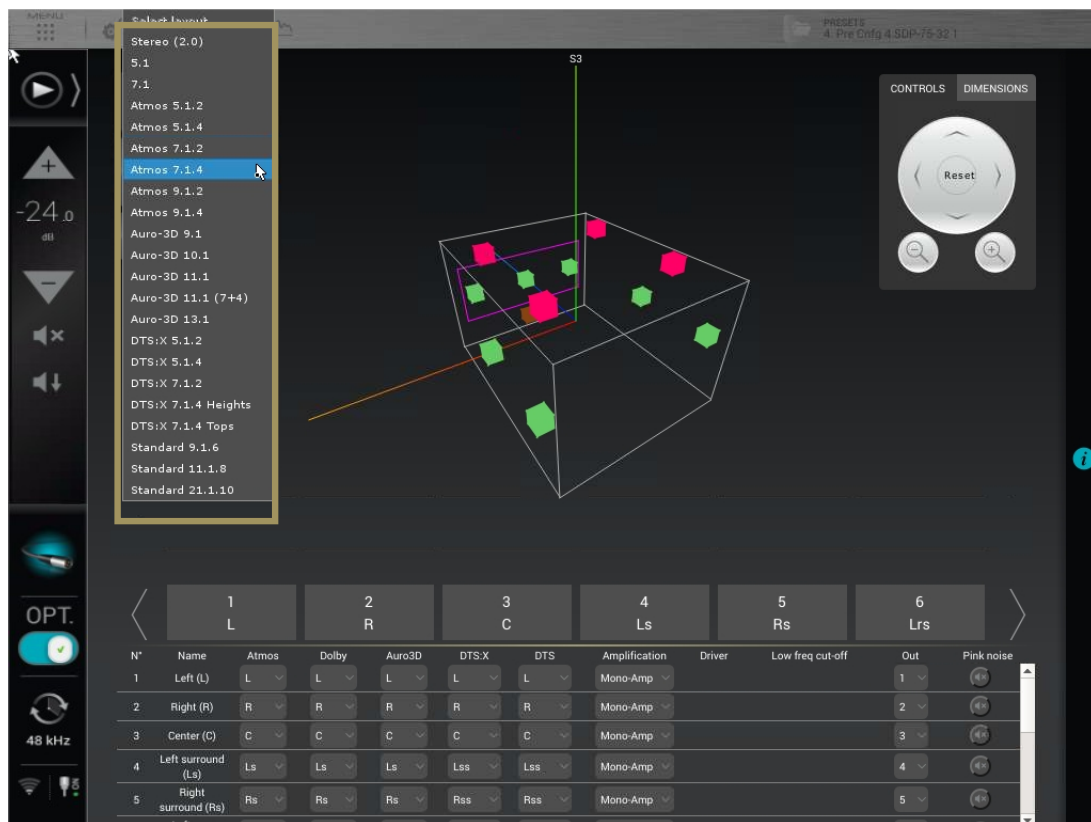

Figure 60: Selecting an initial speaker layout

If your system is not in the list, you can either select a smaller system and add the missing speakers, or select a bigger system and remove the extra ones.



IMPORTANT NOTE: it is critical to distinguish *speakers* from *channels* because one speaker may be used to reproduce multiple channels, depending on the audio format which is being played. Therefore, your final speaker configuration on the SDP-75 must include *the same number of amplification channels as in your audio system*.



NOTES:

The **Speaker/Room setup** tool cannot display more speakers than the total number of available outputs in your SDP-75 configuration. There are 16-channel, 24-channel and 32-channel SDP-75 models. For example, if you have a 24-channel SDP-75 model, the **Speaker/Room setup** tool will display up to 24 speakers.

Channel assignment for each format is one of the next steps.

8.6 ADDING SPEAKERS

8.6.1 ADDING REGULAR SPEAKERS

If required, the next step is to add speakers to achieve a configuration that fits your system.

To add one or more speakers:

- click on the **Add Speaker** button
- in the **From Layout** drop-down list, select the speaker template from which you want to add one or more speakers: all the speakers available in the selected speaker layout are displayed in *grey* color;
- click on the speaker you want to add: it will be displayed in *yellow* color;
- click on the **Add button** next to the **Speaker position** drop-down list;

Repeat this process for each additional speaker you want to add.

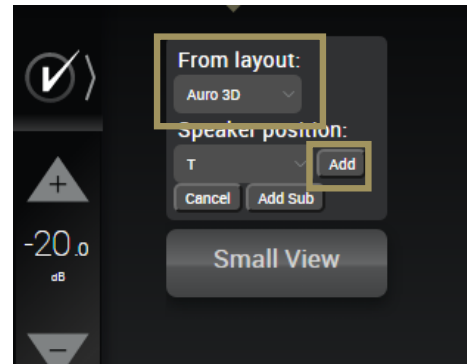

Figure 61: Adding a speaker



IMPORTANT NOTE: Some configurations are not allowed by the decoder specifications. In such case, a red warning will be displayed on the side panel and the relevant speakers will be highlighted in red.



The side panel gives you some information on the prerequisite conditions for some speakers.



NOTE: If you choose to add a speaker, the SDP-75 will automatically suggest to add the mandatory associated speaker(s). This will help you to keep the integrity of the recommendations of each decoder.

Add associated speaker?

To use 'Ltf' in atmos configuration the following speaker is mandatory:
RtF
Do you want to add the associated speaker?

YES NO

To add a subwoofer:

1. Click on the **Add Speaker** button;
2. Click on the **Add Sub** button below the **Speaker position** drop-down list.

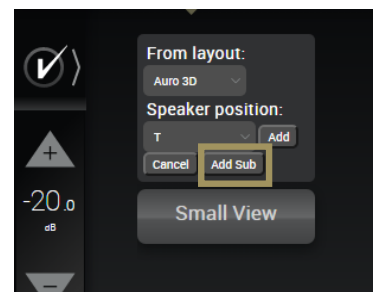

NOTE: The **Add Sub** button adds subwoofers regardless of formats. The subwoofer positions displayed are not significant and will not affect the sound.

8.6.2 ADDING DOLBY ENABLED UPFIRING SPEAKERS

If your configuration has some Dolby-Enabled up-firing speakers, they appear on the 3D view as ceiling speakers as they are used to reproduce elevation channels. In the drop-down list, those speakers end in an "e" which stands for "enabled".

Here are the available Dolby-Enabled speakers:

- **Le**: Left up-firing Dolby-Enabled speaker;
- **Re**: Right up-firing Dolby-Enabled speaker;
- **Lse**: Left Surround up-firing Dolby-Enabled speaker;
- **Rse**: Right Surround up-firing Dolby-Enabled speaker;
- **Lrse**: Left Rear Surround up-firing Dolby-Enabled speaker;
- **Rrse**: Right Rear Surround up-firing Dolby-Enabled speaker;

To add a Dolby-enabled speaker from the drop-down list, please use the normal procedure explained above in the *Adding Regular Speakers* sub-chapters.

To add a Dolby-enabled speaker from the 3D view, click on one of the Dolby Top Speakers. As explained above, the Dolby-enabled speakers are using the signal from Top speakers to recreate the immersion effect. The speakers concerned are

- Left and Right Top Front (Ltf/Rtf);
- Left and Right Top Middle (Ltm/Rtm);
- Left and Right Top Rear (Ltr/Rtr).

Use the procedure explained in the previous chapter to add a speaker from the 3D view. Select one of the speakers listed above. When clicking on **Add**, a dialog box will appear asking you to choose between the regular in-ceiling speaker or the associated Dolby-enabled up-firing speaker. Select the desired one.

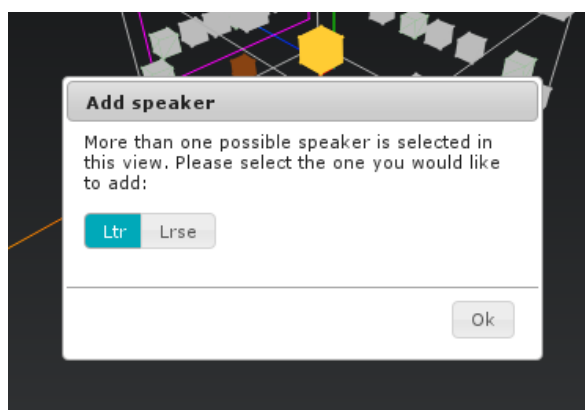

IMPORTANT NOTE: The last speakers on the list are up-firing Dolby-Enabled speakers. Dolby-Enabled speakers have an included filter designed to enhance the immersion effect.



NOTE: Dolby-Enabled up-firing speakers use elevation speaker channels. In cases in which both Dolby-Enabled and ceiling speakers are used, some conflicts can occur. It will appear on the side panel.



8.7 REMOVING SPEAKERS

To remove one or more speakers (including subwoofers):

- Click on the speaker you want to remove, either in the 3D representation or in the list: it will be displayed in *yellow*.
- Click on the **Remove speaker** button.

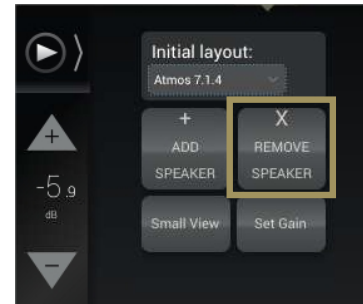

8.8 CONFIGURE THE SETTINGS OF EACH SPEAKER

Once the complete set of speakers in your system is defined, you can configure the settings of each speaker.

The **speaker configuration table** located in the lower part of the Speaker/Room setup tool allows you to:

- Manually map the channels of the Dolby, Dolby Atmos, DTS, DTS:X or Auro-3D formats to each speaker;
- Configure the arrays of speakers for Dolby and DTS legacy format (optional) (See **Speakers Arrays** chapter below);
- Configure the active crossover settings (optional);
- Specify the physical output for each speaker/driver;
- Send pink noise to the assigned physical output in order to verify that the routing of each channel to each loudspeaker/driver is correct.

The **Small View** button reduces the 3D view and enlarges the speaker configuration table.

Every speaker can be further configured as follows:



Figure 62: The speaker configuration table

Speakers name

Channel mapping

Multi amplification

Output channel

You can select speakers:

- by clicking on the speaker in the 3D view,
- by clicking on the corresponding channel number/name in the table's header
- by clicking on one of the lines of the table

The currently selected speaker is displayed in yellow in the 3D view.

The available settings for each speaker are the following:

- Dolby, Dolby Atmos, Auro3D, DTS and DTS:X **channel mapping**: see below.
- Amplification: see below.
- **Output Channel**: specifies the physical output to be used for the speaker/driver.
- **Pink noise**: plays a -20dBFS pink noise on the specified output.

8.9 CONFIGURE THE CROSSOVER SETTINGS (OPTIONAL)

If you want to use the active crossovers of the SDP-75, you must use the speaker configuration table to:

- Specify the type of amplification: bi-amp, tri-amp or quad-amp;
- Specify the crossover frequency

The parameters related to crossover settings are the following:

- **Amplification:** sets the number of channels of the speaker in case of multi-amplification
- **Low freq cut-off:** sets the crossover frequencies
- for bi-amp, it is set at 2kHz by default;
- for tri-amp, they are set at 200Hz and 2kHz by default;
- for quad-amp, they are set at 200Hz, 2kHz and 20kHz by default.



NOTES:

- The SDP-75 handles up to 4-way active crossovers.
- The default crossover filters are Linkwitz Riley 4th-order (24dB/Oct).
- Advanced crossover settings are available in the **Setup/ActiveXovers** page of the Advanced Settings user interface. Further information about the active-crossovers can be found in the **Calibrate the Active Crossovers** chapter.

8.10 MAPPING THE CHANNELS OF DIFFERENT FORMATS

The new Immersive Audio Formats (Auro-3D, Dolby Atmos and DTS:X) come with different channel labels and different speaker placement recommendations. This causes incompatibility issues that could make it difficult to play the required content correctly.

In the SDP-75, each speaker can be assigned to a specific channel for each format in such a way that it will play the required content regardless of the format being decoded.

In the example below, one speaker was set as the "Top" speaker recommendation of Auro Technologies to reproduce the content of the **Auro-3D Top channel** ("voice of god"). This channel also exists in **DTS:X as the "Oh" channel** but does not exist in the Dolby Atmos format. Therefore, this speaker will not be used during playback of native Dolby Atmos formats.

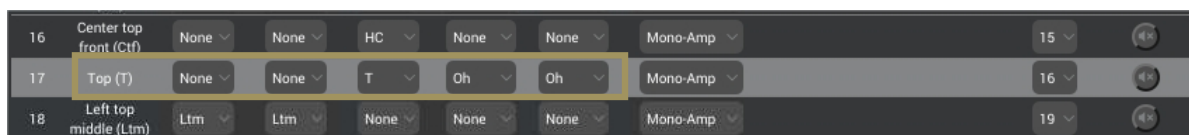

Figure 63:

Channel mapping example for the Top channel

In the example below, the SDP-75 has automatically assigned the **Left top front (Ltf)** channel, initially specified as an Atmos speaker, to play the **Height Left (HL)** channel of Auro3D content.

11	Right front height (Rfh)	Rfh	Rfh	None	None	None	Mono-Amp	32	
12	Left top front (Ltf)	Ltf	Ltf	HL	Ltf	Ltf	Mono-Amp	11	
13	Right top front (Rtf)	Rtf	Rtf	HR	Rtf	Rtf	Mono-Amp	12	

Figure 64: Channel mapping for the Left top front (Ltf) channel



NOTE: The channel labels and speaker positions of each format are available in the appendix of this document.



NOTE: To configure an array of speakers, please refer to the next chapter : Speaker Arrays

8.11 SENDING PINK NOISE TO VERIFY THE ROUTING OF THE SPEAKERS

As soon as the detailed configuration for each speaker is completed, it is critically important to verify that the routing of the channels to the speakers is correct, and to correct any errors. Otherwise the consistency of the sound reproduction will be compromised.



IMPORTANT NOTE: This procedure only helps to verify that the routing is correct *from the SDP-75 to the speakers*. In addition to this procedure, when a new source is connected to the SDP-75, you should also verify that the routing is correct *from the source to the SDP-75*.

To verify the routing of each speaker:

- Select the speaker by clicking in the 3D view or by selecting the corresponding line in the speaker table;
- Click on the Pink Noise icon;
- Locate the speaker through which the pink noise is being played;
- Verify that the playing speaker matches the selected channel in the SDP-75's Speaker/Room setup tool;
- If there is no match, fix the routing of the speaker by modifying the assigned Output.



Figure 65: sending pink noise to the speakers

 **IMPORTANT NOTE:** The SDP-75 needs to be synchronized on an audio clock, either external (Secondary mode) or internal (primary mode) in order to produce the pink noise. If a Digital source is no synchronization signal, the pink noise won't be produced. In such case, we simply recommend selecting an analog source.

8.12 SAVE THE PRESET

Last but not least, don't forget to **save** the preset to make sure the settings of your speaker layout will not be lost.

9 SPECIFY AN ARRAY OF SPEAKERS

With the release of new 3D audio formats, the number of possible speaker positions increases considerably. Nevertheless, your video library is surely full of "surround" content (5.1 or 7.1). Furthermore, 3D formats do not all have the same limitation in terms of simultaneous active speakers.

So it becomes essential to be able to create an array of speakers: use several speakers to play the same channel. It is also possible to adjust the gain of each speaker of the array to perfectly match the needs of the Home-Theater; Thereby, the immersion effect is much more impressive!

Similar configurations have been used in commercial cinemas for years.

9.1 SETTING UP AN ARRAY OF SPEAKERS

Once your speaker's layout has been declared, configured and fully tested, you can now set up your arrays of speakers. The SDP-75 is able to duplicate the incoming channel from the decoders on several speakers.

The setup of an array has to be done within the **Speaker/Room setup** tool, using the mapping column of each decoder. As explained in the previous chapter **Specify a speaker layout, Mapping the channels of different formats** section, each format has its own speaker assignments. You can easily control the number of speakers used by each decoder. Each column defines the channel used by the associated speaker. In this way, you are able to select the same channel on several speakers.

N°	Name	Atmos	Dolby	Auro3D	DTS:X	DTS	Amplification	Driver	Low freq cut-off
1	Left (L)	L	L	L	L	L	Mono-Amp		
2	Right (R)	R	R	R	R	R	Mono-Amp		

In the **Speaker/Room setup** tool, you can observe five columns giving the details of each decoder's layout:

- **Atmos:** Layout used for native Dolby Atmos content and Dolby Surround Up-mixer;
- **Dolby:** Layout used for Legacy Dolby content;
- **Auro-3D:** Layout used for Native Auro-3D content and Auro-3D Up-mixer;
- **DTS:X:** Layout used for native DTS:X content and Neural:X Up-mixer;
- **DTS:** Layout used for Legacy DTS content.

To specify a speaker layout, please select, in the drop down menu of each speaker, the desired channel that it has to play for each decoder.



IMPORTANT NOTE: DTS:X is limited to 11 different channels. Nevertheless, you can use the arrays to duplicate these 11 channels and use more than 11 speakers.

9.2 EXAMPLE OF AN ARRAY OF SPEAKERS

Below is an example of a specific speaker layout designed to array some channels:



N°	Name	Atmos	Dolby	Auro3D	DTS:X	DTS	Amplification	Driver	Low freq cut-off	PEQ	Out	Pink noise
1	Left (L)	L	L	L	L	L	Mono-Amp				1	
2	Right (R)	R	R	R	R	R	Mono-Amp				3	
3	Center (C)	C	C	C	C	C	Mono-Amp				5	
4	Left surround (Ls)	Ls	Ls	Ls	Lss	Lss	Mono-Amp				7	
5	Right surround (Rs)	Rs	Rs	Rs	Rss	Rss	Mono-Amp				8	
6	Left rear surround (Lrs)	Lrs	Lrs	Lb	Lsr	Lsr	Mono-Amp				9	
7	Right rear surround (Rrs)	Rrs	Rrs	Rb	Rsr	Rsr	Mono-Amp				10	
8	Left wide (Lw)	Lw	Lw	None	None	None	Mono-Amp				11	
9	Right wide (Rw)	Rw	Rw	None	None	None	Mono-Amp				12	
10	Left top front (Ltf)	Ltf	Ltf	HL	Ltf	Ltf	Mono-Amp				13	
11	Right top front (Rtf)	Rtf	Rtf	HR	Rtf	Rtf	Mono-Amp				14	
12	Left top rear (Ltr)	Ltr	Ltr	HLs	Ltr	Ltr	Mono-Amp				15	
13	Right top rear (Rtr)	Rtr	Rtr	HRs	Rtr	Rtr	Mono-Amp				16	
14	Center top front (Ctf)	None	None	HC	None	None	Mono-Amp				17	

In the example above, please pay attention to Left Wide and Right Wide speakers:

- For Dolby Atmos content, Left and Right Wide speakers will play natively as they natively existing in the CODEC;
- For Dolby Legacy content, Left and Right Wide speakers will play Ls and Rs channel, simultaneously with Left and Right surround speakers;
- For Auro 3D content, Lw and Rw does not exist natively. In this configuration Left and Right Wide speakers will play Ls and Rs channels simultaneously with Left and Right Surround speakers;
- For DTS:X content, Left and Right Wide speakers will play Lss and Rss channel simultaneously with Left and Right surround speakers;
- For DTS Legacy content, they will play Lss and Rss channel simultaneously with Left and Right surround speakers;

9.3 ADJUST THE GAIN

When you decide to make an array, you may need to adjust the gain of each speakers accordingly to each decoder. It is possible to do it speaker by speaker, or to select a group of speakers to apply the same gain adjustment.

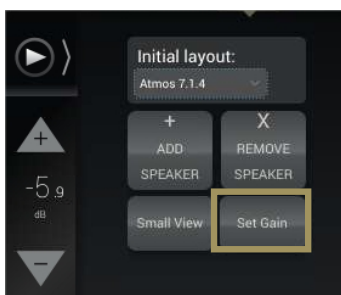

To access the speaker's gain control panel, click on the Set Gain button in the **Speaker/Room setup** tool. Instead of the channel assignment, the gain control will be displayed.

The screen below displays the **Set Gain** control panel. Each channel assigned from each speakers has a value (default: 0) surrounded by - and + buttons. Use those buttons to adjust the gain in 1dB increments.

By clicking on a value, you also can manually enter a gain. In this case, a virtual numerical keyboard is displayed.



Figure 66: Set gain control panel

The Selected Selected speakers can all be modified simultaneously using the control panel in the top left corner.

You can add or decrease gain using **-1dB** or **+1dB** buttons, or by using the **Direct input** and its numerical keyboard.

The **Reset** button clears any modification and sets the default value of 0dB.

The **Clear selection** unselects every speaker, keeping the modified values.

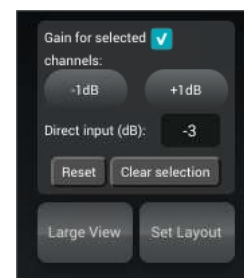

IMPORTANT NOTE: High gain values can damage a speaker.

9.4 SAVE THE PRESET

Last but not least, don't forget to **save** the preset to make sure the settings of your arrays of speakers won't be lost.

10 DECODER / UP-MIXER SETTINGS

The SDP-75 allows you to enjoy various kinds of surround and stereo playback modes using the decoders mentioned below. With the 3D codecs option, you also are able to extend your stereo or basic multichannel content (5.1/7.1) to a full 3D sound, and so use most of the speakers specified in the setup procedure. These are the Up-mixers:

10.1 SUPPORTED DECODERS/UP-MIXERS

A number of surround and 3D decoders are implemented in the SDP-75:

Dolby decoders:	DTS decoders:	3D decoders:
Dolby Digital Dolby Digital Plus Dolby TrueHD	DTS Digital Surround DTS-HD High Resolution Audio DTS-HD Master Audio	Dolby Atmos DTS:X Auro-3D
  	  	  

With the 3D option, the SDP-75 also supports the following surround Up-mixers:

Dolby Surround[®]
DTS Neural:X[®]
Auro-Matic[®]



NOTE: Some speakers are not utilized by every decoder. In this case, they will remain silent while this decoder is active. For example, the "Top" speaker is not used by Dolby Atmos, so this speaker will only be used while playing DTS:X and Auro-3D content, and also if you use their respective up-mixer.

10.2 LISTENING FORMATS

The Listening Format dropdown menu provides you several options. Some of them may sound familiar to you, while the others could be unknown. The list gives you:

- **Auto:** The incoming encoded content will be played with the corresponding up-mixer.
- **Dolby Surround:** The incoming content will be played using the Dolby Surround up-mixer.
- **Neural:X:** The incoming content will be played using the DTS Neural:X up-mixer.
- **Auro-3D:** The incoming content will be played using the Auro-3D up-mixer.
- **Native:** The incoming content won't be modified and will be played as it is.
- **Up-mix on Native:** The incoming content will be played using the corresponding up-mixer, but with the Legacy speaker layout (Dolby or DTS column).
- **Legacy:** This listening format will only play the "bed" layout of the content (5.1 or 7.1) and will ignore the 3D layout.
- **Custom:** You are not able to select this mode manually, but it is automatically selected as soon as you change any of the decoder's settings.

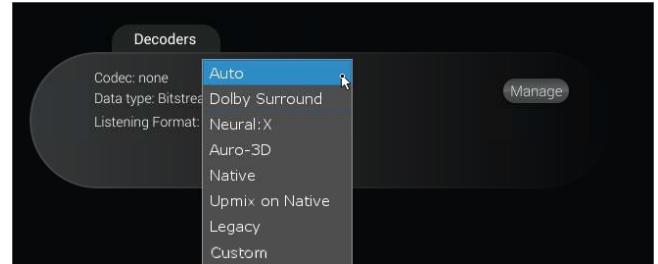

NOTE: Depending of the incoming format decoded by the SDP-75, the listening format listed above will exhibit different behaviors. Please read the chart below carefully, which indicates the behavior of each listening format relative to the source format.

Source format Up-mix mode	PCM	Dolby (DD, DD+, TrueHD)	Native Dolby Atmos	DTS (Legacy, HD Master Audio)	DTS:X	Native Auro-3D*
Auto	None (No Up-mix) Layout used : Selected in Decoder General settings	Dolby Surround Up- mixer Layout Used : Atmos	Native Dolby Atmos Layout Used : Atmos	Neural:X Up-mixer Layout Used : DTS:X	Native DTS:X Layout Used : DTS:X	Native Auro-3D (2) Layout Used: Auro-3D
Dolby Surround	Dolby Surround Up- mixer (1) Layout Used : Atmos	Dolby Surround Up- mixer Layout Used : Atmos	Native Dolby Atmos Layout Used : Atmos	Dolby Surround Up- mixer Layout Used : Atmos	Native DTS:X Layout Used : DTS:X	Dolby Surround Up- mixer Layout Used : Atmos
Neural:X	Neural:X Up-mixer Layout Used : DTS:X	Neural:X Up-mixer Layout Used : DTS:X	Native Dolby Atmos Layout Used : Atmos	Neural:X Up-mixer Layout Used : DTS:X	Native DTS:X Layout Used : DTS:X	Neural:X Up-mixer Layout Used : DTS:X
Auro-3D	Auro-3D Up-mixer (1) Layout Used : Auro-3D	Auro-3D Up-mixer Layout Used : Auro-3D	Native Dolby Atmos Layout Used : Atmos	Auro-3D Up-mixer Layout Used : Auro- 3D	Native DTS:X Layout Used : DTS:X	Native Auro-3D* Layout Used: Auro-3D
Native	None (No Up-mix) Layout used : selected in Decoder General settings	None (No Up-mix) Layout Used : Dolby	Native Dolby Atmos Layout Used : Atmos	None (No Up-mix) Layout Used : DTS)	Native DTS:X Layout Used : DTS:X	Native Auro-3D* Layout Used: Auro-3D
Up-mix on Native	Up-mix following the default PCM layout in the Decoder General settings	Dolby Surround Up- mixer Layout Used : Dolby	Native Dolby Atmos Layout Used : Atmos	Neural:X Up-mixer Layout Used : DTS	Native DTS:X Layout Used : DTS:X	Native Auro-3D* Layout Used: Auro-3D

Legacy	None (No Up-mix) Layout used : selected in Decoder General settings	None (No Up-mix) Layout Used: Dolby	Bed (Original 7.1) Layout Used : Dolby	None (No Up-mix) (2) Layout Used : DTS	Bed (Original 7.1) Layout Used : DTS	Bed (Original 7.1) Layout Used : Auro-3D
---------------	--------------------------------------------------------------------------------	------------------------------------------	---------------------------------------------	------------------------------------------------	-------------------------------------------	-----------------------------------------------

Figure 67 Chart of the behavior between source format and listening mode

KNOWN ISSUES

(1) Potential issue with stereo PCM sources (typically CD): the HDMI outputs of some Blu-Ray players declare 7.1 channels instead of 2. In such case, surround and rear channels will not be up-mixed. This issue comes from the player, not from the SDP-75. The only solution is to force the player to deliver 2 channels.

(2) Potential issue with Auro-3D content: Auro-3D may not be detected in Listening Format Auto. In such cases, the up-mixer of the Bed format will be used. If it is Auto-3D PCM material, the up-mixer used will depend of the PCM default layout selected in the Decoders General Settings. If this happen, selecting Auro-3D listening format will play Native Auro-3D content.

CPU LOAD: Do not forget that Up-mixers require a lot of CPU resources, especially in 96 kHz with high channel count.

Auro-Matic: The Auro-3D up-mixer does operate up to 96 kHz but not with higher sampling rates.

Neural:X: The Neural:X up-mixer does operate up to 48 kHz but not with higher sampling rates.

- * Please refer to the important note below.

For detailed information about the surround up-mixers, please contact the JBL Synthesis Support Team.



IMPORTANT NOTE: Sometimes, in Auto or Native listening format, Auro-3D content may not be correctly detected and decoded at the input. In this situation, only 5.1 or 7.1 content will be considered. If so, please set the **Listening Format** on Auro-3D to ensure the complete Auro-3D decoding. This behavior will be solved in a future software release.

10.3 USING THE FRONT PANEL

10.3.1 LISTENING FORMAT SELECTION

From the front panel of the SDP-75, press the **Menu** button. Using the **Select** knob, navigate to the “**Listening Format**” menu, confirm using the **Enter** button.



Then choose the desired listening format, still using the **Select** knob, and confirm using the **Enter** button. The current listening format is underlined.

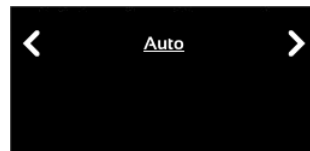

10.3.2 DECODERS CONFIGURATION

To configure the Decoders from the front panel, press the **Menu** button. Using the **Select** knob, go to the **Setup** menu. Confirm using the **Enter** button.



Then, using the **Select** knob, go down the list and select **Decoders**, and confirm with the **Enter** button.

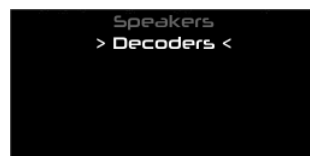

Finally, select the decoder you want to configure, and confirm with the **Enter** button.

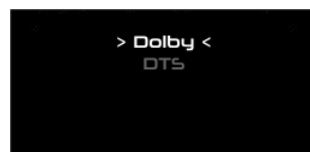

10.4 USING THE GRAPHICAL INTERFACE

10.4.1 LISTENING FORMAT SELECTION

To activate a surround up-mixer:

1. Click on the “IN sources” menu item of the lateral menu to go to the **Sources** page;
2. Select a Listening Format in the drop down list.

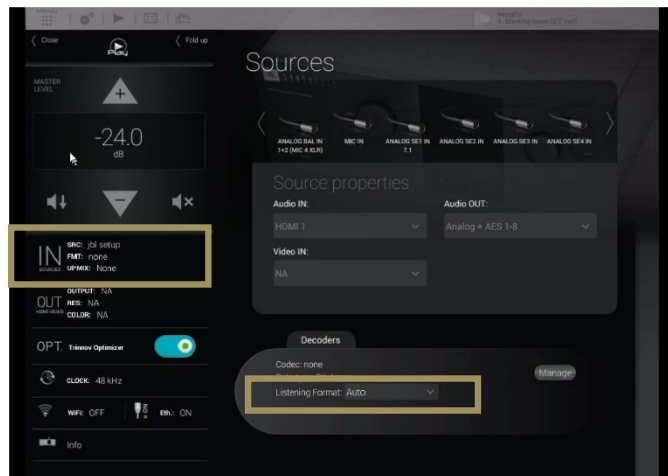

Figure 68: The surround up-mixer option

10.4.2 DECODER CONFIGURATION

To configure the decoder parameters for the Dolby, DTS and Auro-3D decoders:

1. Click on the “IN sources” menu item of the lateral menu to go to the **Sources** page;
2. In the **Sources** page, click on the **Manage** button in the **Decoders** section. This gives you access to the decoders settings described below.

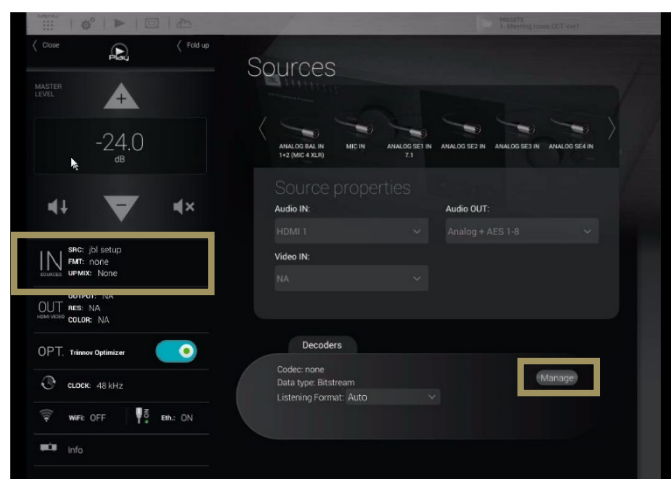
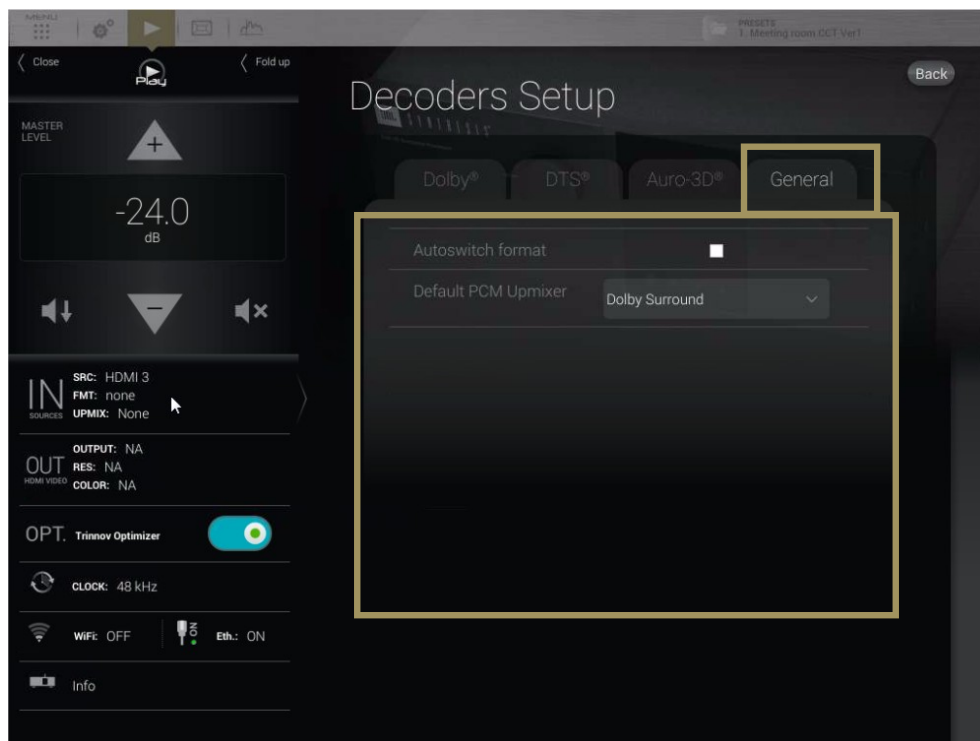

Figure 69: Accessing the decoders setup from the Sources page

10.5 DECODERS SETTINGS

The different decoders' settings given below are available through the graphic interface or through the front panel screen (see above).

10.5.1 GENERAL SETTINGS



The **General** tab provides you different settings to configure the decoding behavior of the SDP-75 that does not directly concern the decoders.

- **Autoswitch format** : When this option is activated, the SDP-75 will automatically switch to the input format of the decoder. The SDP-75 virtually replaces the speakers at their ideal position recommended by the current decoder and provides you the best immersive conditions. If this setting is not enabled, you must manually select a desired source format in the **Setup/Source** menu of the Advanced interface.
- **Default PCM Up-mixer** : The PCM format has no decoder, thus there is no assigned speaker layout. This setting allows the assignment of a default layout and up-mixer for incoming PCM content.

10.5.2 DOLBY DECODER SETTINGS

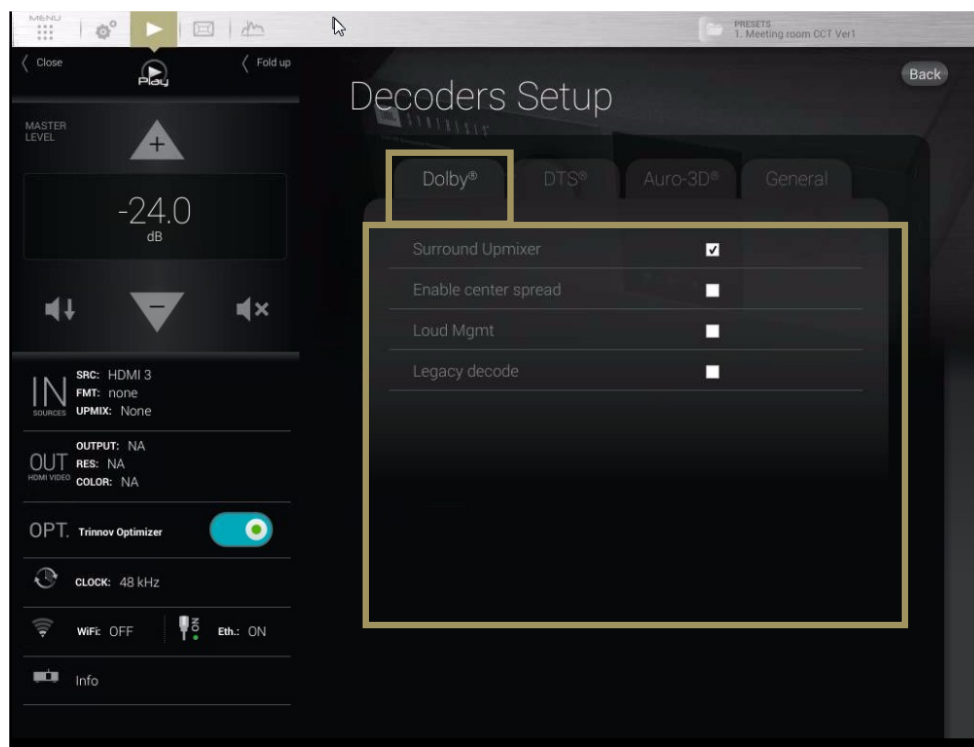

Figure 70: Dolby decoder settings

- **Surround Up-mixer:** switch on/off the Dolby surround up-mixer;
- **Enable center spread:** spread the Center channel across the Left and Right speakers. Creates a wider sound stage, recommended for playing musical content;
- **TrueHD Loudness Management :** use the loudness management information provided in the incoming signal's metadata;
 - **DRC Settings:**
 - **Auto:** Automatic DRC low level boost and high level cut;
 - **Enabled:** Enable the Dynamic Range Control management;
 - **Disabled:** Disable the Dynamic Range Control management;
 - **DRC Low-Level Boost:** Amount of low-level boost;
 - **DRC High-Level Cut:** Amount of high-level cut;
- **Legacy decode:** extract the legacy content (5.1 or 7.1) from the incoming Dolby Atmos content.

10.5.3 DTS DECODER SETTINGS

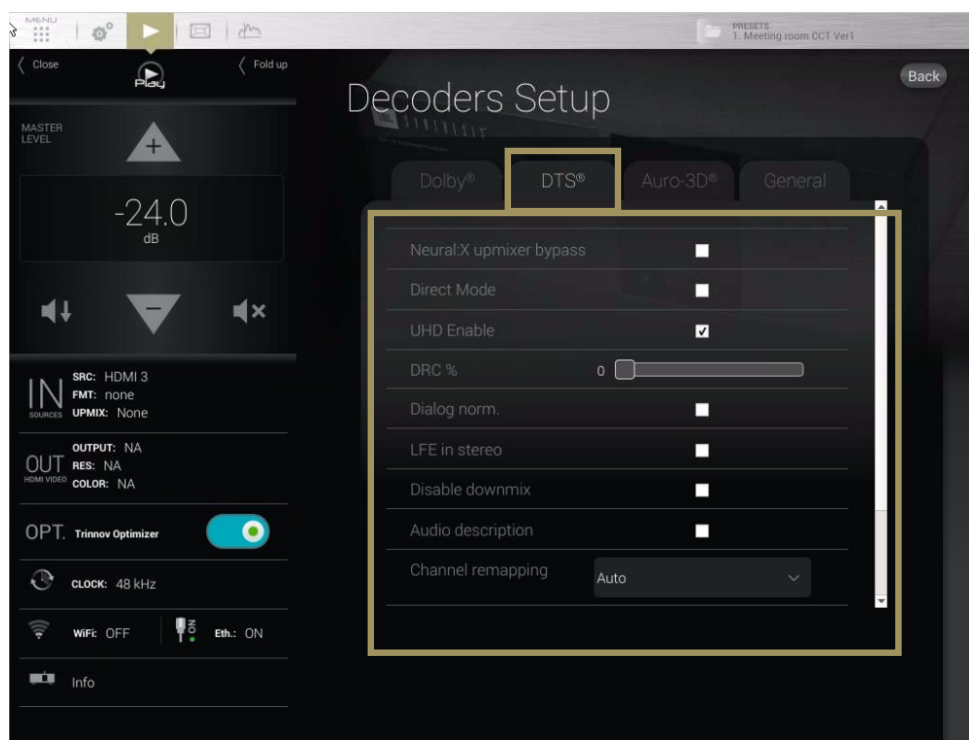

Figure 71 : DTS:X Decoder Settings

- **Neural:X Up-mixer Bypass:** Disables the Neural:X Up-mixer;
- **Direct Mode:** In "Direct Mode," the audio is extracted and reproduced as closely as possible to what the content creator intended. At a high-level, direct mode attempts to most closely preserve the original speaker layout with no additional processing to take advantage of additional speakers;
- **UHD Enable:** Allows rendering the 3D object. If this function is disabled, the decoder will play only on legacy (5.1/7.1) speakers;
- **DRC%:** sets a percentage of Dynamic Range Control ;
- **Dialog norm:** use the incoming metadata to adjust the level of the center channel;
- **LFE in stereo:** send the LFE to a pair of subwoofers ;
- **Disable down-mix:** Do not down-mix surround formats into stereo;
- **Audio description:** switch **on** the visual description track intended for the blind and visually impaired ;
- **Channel remapping:** This setting is only applicable for surround formats
 - **None :** No channel remapping is applied
 - **Auto:** apply automatic channel remapping that matches the incoming channels to the speaker system;
 - **Auto on DTS configs:** apply automatic channel remapping accordingly to some specific speakers configurations determined by DTS
 - **2.0 – 7.1 settings:** force playback on a specific speaker configuration such as 7.1 independently from the incoming channels;
- **Solo stream:** enable the Primary or Secondary solo stream.
- **Interactive Object:** If interactive objects are available on the content in use, a slider will provide a volume control on these interactive objects. The slider is disabled if no interactive objects are available. The interactive objects are usually dialog objects, therefore you are able to adjust the dialog level.

10.5.4 AURO-3D DECODER SETTINGS

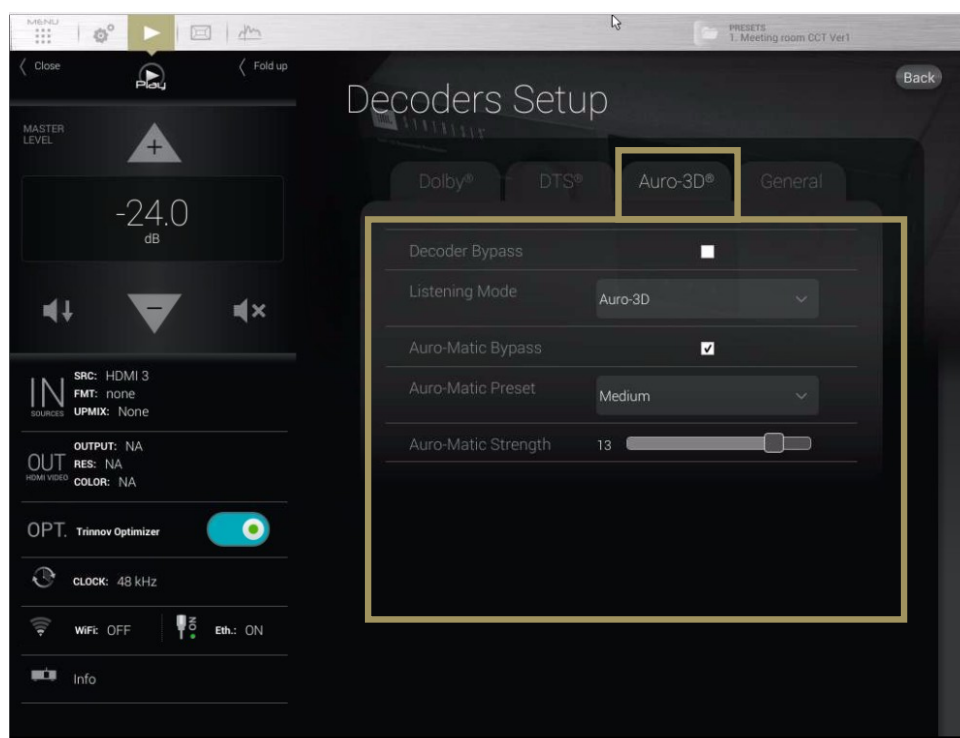

Figure 72: Auro-3D decoder settings

- **Decoder bypass:** bypass the Auro-3D decoder;
- **Listening mode:**
 - **Auro-3D:** enforce playback on the Auro-3D speaker layout. Incoming surround content is *up-mixed* to the Auro-3D format ;
 - **Surround:** enforce playback on the surround speaker layout, so that height speakers are disabled. Incoming stereo content is *up-mixed* to a surround format and incoming Auro-3D content is *down-mixed* to a surround format.
 - **Stereo:** enforce playback in stereo. Incoming surround content is *down-mixed* to the stereo format.
- **Auro-matic Bypass:** switch on/off the Auro-matic up-mixer;
- **Auro-matic Preset:** choose different settings for the Auro-matic up-mixer;
- **Auro-matic Strength:** sets the strength of the Auro-matic up-mixer.

11 PREPARING FOR CALIBRATION

This chapter explains very important tips to ensure a smooth and safe calibration process, as well as important recommendations for **microphone placement** in order to perform high quality measurements.

11.1 VERY IMPORTANT TIPS

Important Notes:

- Active Crossovers need to be calibrated prior to Optimizer, Level, or Delay Adjustments.
- Primary 48 kHz clock modes should be used for measurement. (Factory default for the microphone input.)



Avoiding feedback loops:

- Always **MUTE** the processor as the first step of the calibration procedure. Muting the outputs does not affect the calibration signal.
- Be careful with feedback issues when you change the routing you could make dangerous feedback loops between the microphone and the loudspeakers.

Avoiding warning messages during calibration:

- Disable the subwoofer's built-in filters: a narrow bandwidth can disturb the measurement.
- Adjust levels between amplifier/active speakers before calibration to avoid dangerous level jumps.

11.2 CHECKLIST BEFORE YOU START

Please go through the following checklist to make sure you are ready to start the calibration process:

- You've read carefully the whole chapter about the SDP-75's Essential Tools and Settings that you'll be using throughout the calibration process.
- The speaker layout (including multi-amplified speakers) has been specified in the SDP-75 Speaker/Room Setup Tool.
- The routing of the speakers/drivers has been verified by playing pink noise with the SDP-75 Speaker/Room Setup Tool.
- All the speakers (including the subwoofers) are installed in their final positions and orientations, and connected to their amplifiers in the proper polarity.
- The measurement microphone is switched OFF, placed securely on a mic stand or camera tripod, and connected to the SDP-75 MIC input.
- The **MIC** input is selected as a source for a 5 pin XLR microphone, or **ANALOG BAL IN 1+2 (MIC 4 XLR)** for a 4 XLR microphone
- You have access to the Advanced Settings user interface via a screen directly connected to the SDP-75, or through a VNC client.

11.3 IMPORTANT RECOMMENDATIONS FOR MICROPHONE PLACEMENT

11.3.1 REQUIREMENTS FOR THE MEASUREMENT ENVIRONMENT

At least a few basic rules should be respected to ensure a robust measurement:

- No obstacle between the speaker and the microphone.
- No highly reflecting surface (leather sofa, glass table...) close to the microphone.
- No background noise during the measurements (Air conditioning, open doors, windows etc...)
- No movement during the calibration (disturbs speaker localization)

11.3.2 REFERENCE MEASUREMENT POINT

The SDP-75 supports single-point and multi-point calibrations. In both scenarios, a **reference measurement position** should be chosen carefully since it will be used by the Optimizer for:

- Cross-over driver alignment
- Loudspeaker relative delay/level alignment
- Master delay/level calculation

11.3.3 POSITION AND ORIENTATION OF THE MICROPHONE FOR THE REFERENCE POINT

The calibration microphone should be placed at the listening position, using the listener's ears as a reference for its height. A **red led** shows the front of the microphone. The red led must be pointed to the **front** of the sound stage, towards the **center speaker**.

During the calibration process the microphone should be attached to a microphone stand or a camera tripod.

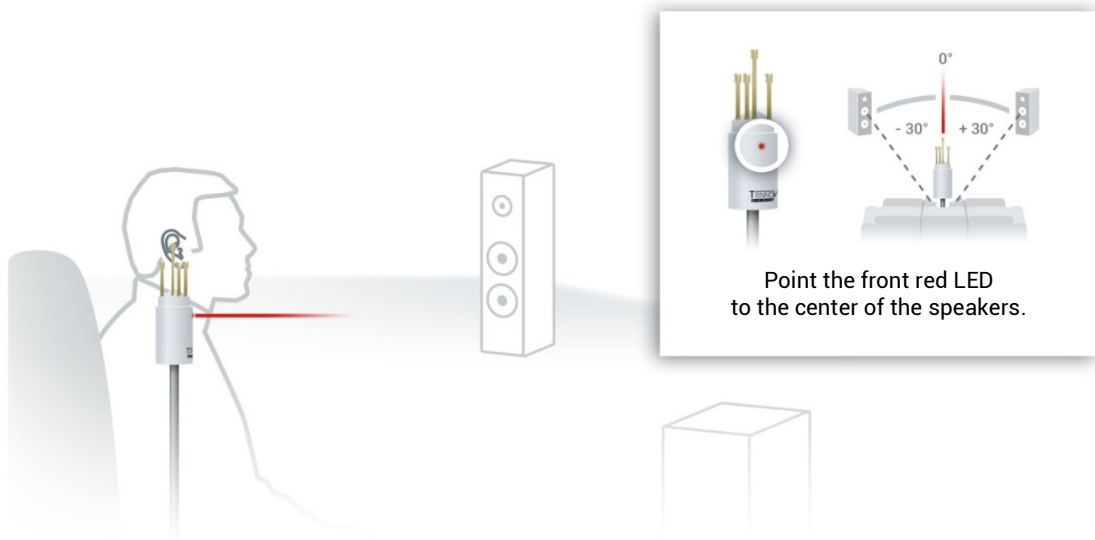

Figure 73: Microphone reference position

12 CALIBRATE THE ACTIVE CROSSOVERS (OPTIONAL)

This chapter explains how to calibrate the active crossovers included in the SDP-75. It assumes that you are familiar with active crossovers and multi-amplified speakers, and is not intended as a course. If you are not using the active crossover functionality of the SDP-75, please skip to the next chapter.



IMPORTANT NOTE: Carefully read carefully the entire chapter about the SDP-75 *Essential Tools and Settings* that you will be using throughout the calibration process.



NOTE: *Primary 44.1 kHz or 48 kHz* clock modes should be used for calibration (*Primary 48kHz* highly recommended).

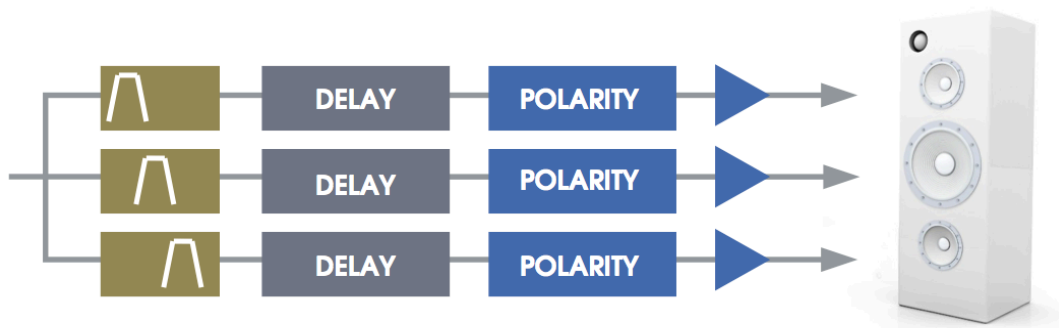

Figure 74: Overview of the active crossovers signal flow

12.1 OVERVIEW OF THE CROSSOVER SETUP PROCEDURE

The overall setup and calibration process of the SDP-75 active crossovers is performed through two different tools:

- Use the **Speaker/Room Setup** Tool to:
 - Configure the number of ways and the crossover frequencies;
 - Verify the routing of the SDP-75 outputs to the correct drivers.
- Use the **Setup/Active Xovers** page of the **Advanced Settings** interface to:
 - Configure the advanced crossover settings such as specific frequencies for each driver and the type of filters (optional);
- Use the **Processor/Meters** page to adjust the master output level;
- Perform the automated calibration of the active crossover: this will automatically determine the level, delay and polarity of each driver;
- Manually adjust levels, delays and polarities of each driver.

The first 2 steps of this process were explained in the previous chapter. This chapter explains the next steps.

12.2 CONFIGURE THE ADVANCED SETTINGS (OPTIONAL)

The SDP-75 includes the following advanced crossover settings:

- Types of filters: 2nd, 3rd, and 4th-order Bessel, 2nd and 4th-order Linkwitz-Riley, and 2nd, 3rd, and 4th-order Butterworth;
- Specific crossover frequency for each driver;
- Level, Polarity and Delay adjustment on each way (driver);



IMPORTANT NOTE: Setup of the crossover filters can be done simultaneously for multiple speakers thanks to their respective Link button. Linking has to be done *before* changing parameters.

Please refer to the speaker manufacturer's specifications to determine the type of filters and crossover frequency.

The **Setup/Active Xovers** page displays one tab for each loudspeaker. The number of loudspeakers displayed depends on the number of loudspeakers specified in the **Speaker/Room Setup** tool.



Figure 75: advanced crossover settings

The following settings are available for each loudspeaker:

- The **type** of high-pass or/and low-pass filters is chosen in the dropdown menu using ▼
- The **cut-off frequency** of each filter is set by using the ◀ arrows ▶ or by manually entering the frequency
- **Level** and **delay** can be adjusted on each way (driver),
- **Mute** and **Invert Polarity** buttons are also available.
- Two additional IIR filters are available under the name of **"Constant-directivity horn" EQ** and **Half "Constant-directivity horn" EQ**. The purpose of such filters is to boost the high frequencies for speakers that use constant-directivity horns. These speakers tend to have too little energy at the highest frequencies in the sweet spot. Depending on the horn you are using, you may want to boost the high frequencies by 3 or 6 dB/oct, from about 3kHz.

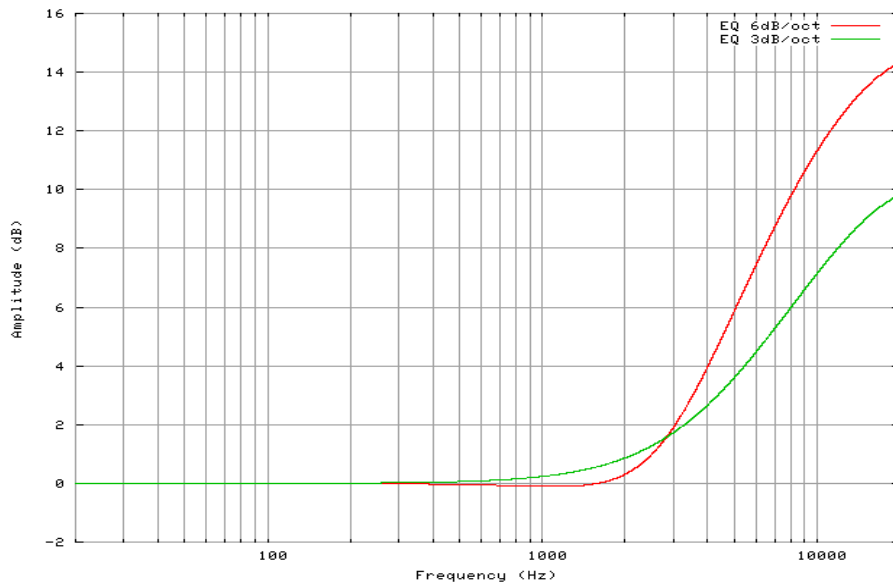

Figure 76: “Constant-directivity horn” EQs

- The **Apply** button is highlighted as soon as a parameter is modified and is used to compute and load the new settings into the processor. Once compute is finished, the gears icon disappears from the notification bar, and filters are applied to the outputs.
- If the changes are unwanted, press the **Cancel Changes** button to cancel your modifications.
- If change is accepted, press the **Save** button of the preset of your choice in the **Presets** page to *save the changes*; otherwise, changes will be lost.

The theoretical model of the specified filters is represented as follows:

- The green curve represents the theoretical low-pass filter response
- The red curve represents the theoretical high-pass filter response
- The blue curve represents the theoretical resulting response of the speakers

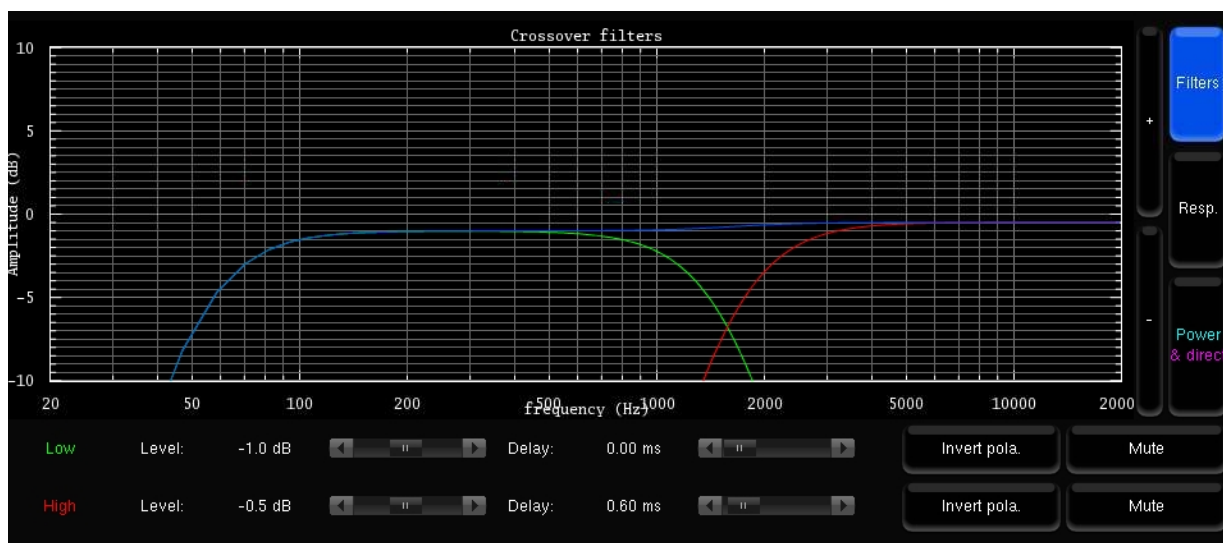

Figure 77: Theoretical model of the specified filters

12.3 ADJUST THE MASTER OUTPUT LEVEL

The SDP-75 requires a minimum Sound Pressure Level for proper calibration of the active crossovers. Until that minimum SPL is reached, the test signal will keep playing through the same driver.

First, be sure that you selected the proper microphone input: **Analog MIC**

- Set a safe output level:
 1. Decrease Master Level to **-40 dB**;
 2. Press the **Mute** button to cut the outputs (this step must ALWAYS be performed before pressing on the **Calibrate** button to avoid a feedback loop);
 3. Switch on the microphone preamp;
 4. Press the **Calibrate** button in the **Setup/ActiveXovers** page of the Advanced Settings interface.
- Adjust output level:
 1. Increase the master level until the test signal moves to the second driver;
 2. Use the SDP-75's metering tools, which are automatically displayed on screen to check the level of the microphone inputs;
 3. Use your ears to evaluate the perceived SPL of each driver and, if possible, increase the master output level to ensure that an optimal SPL is reached for all the drivers. This will also improve the quality of your measurements;
 4. Use the **Cancel** button to stop the calibration (optional).



Figure 78: Crossover calibration page

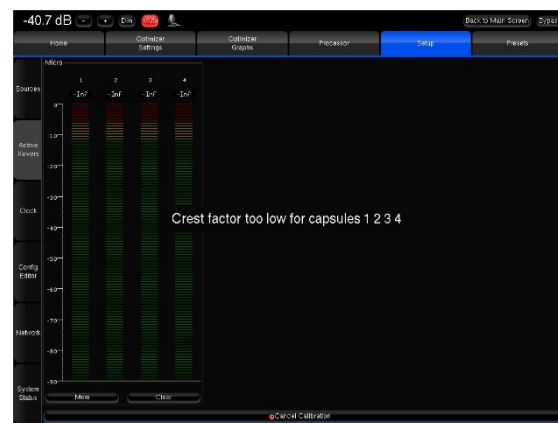

Figure 79: Metering page

Once the level is adjusted, you can move to the next step to perform the final calibration of the active crossover.

12.4 CALIBRATE THE ACTIVE CROSSOVERS

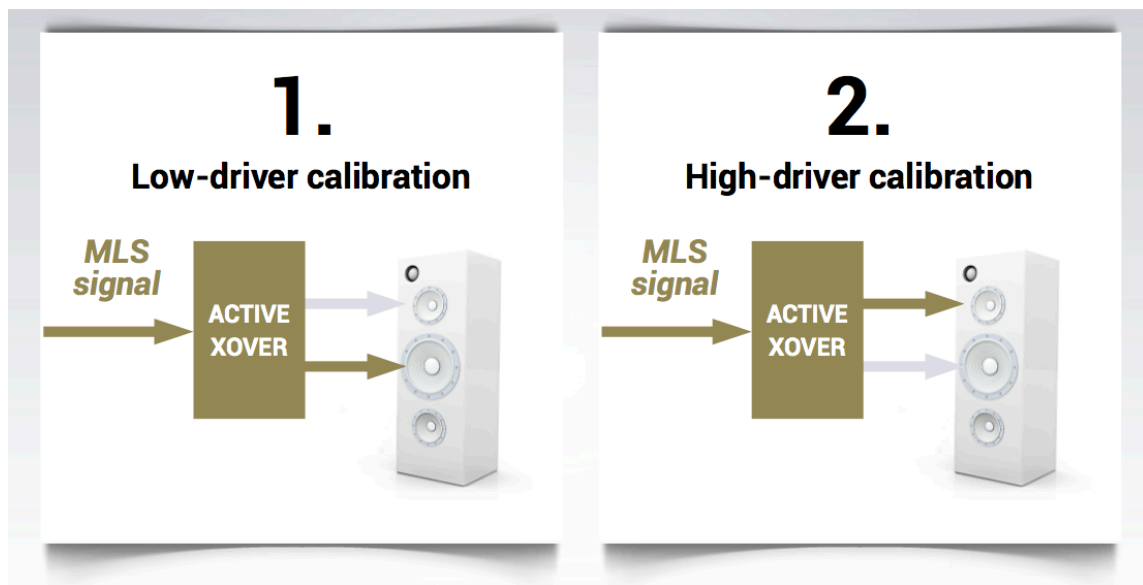

Figure 80: the steps of the calibration process

Once the master output level is set (see previous step), the SDP-75's crossover calibration tool will automatically set up the level, delay and polarity of each driver.

Before calibration, please note:

- The calibration procedure has to be done individually for each speaker;
- An MLS signal is sent to each driver of the selected speaker when the **Calibrate** button is selected;
- At the end of the calibration process, a warning message states that a new calibration of the entire system is required.



Figure 81: Performing the calibration of the active crossovers

Remain in the **Setup/ActiveXovers** page of the Advanced Settings interface to perform the calibration of the active crossovers:

- If two or more speakers are linked, please **unlink** them by turning off the **Link** button.
- Follow the microphone placement instructions (see previous chapter).
- Make sure the measurement environment is silent.
- Press the **Mute** button to cut the outputs (this step must ALWAYS be performed before pressing on the **Calibrate** button)
- Press the **Calibrate** button in the **Setup/ActiveXovers** page of the Advanced Settings interface
- Follow the on-screen instructions regarding the microphone.

12.5 VERIFY THE SOUND OF THE CALIBRATED CROSSOVERS

Once the calibration of the active crossovers is finished, it is *critically important* to verify the sound of the related speakers to identify any possible issues:

- Visualize the acoustic graphs of the speakers connected to the active crossover;
- Listen to the speakers connected to the active crossover.

12.5.1 VISUALIZE THE ACOUSTICAL GRAPHS FOR EACH SPEAKER

You can visualize the results in two forms:

- The measured impulse response of each channel: You can see whether the drivers are correctly synchronized.

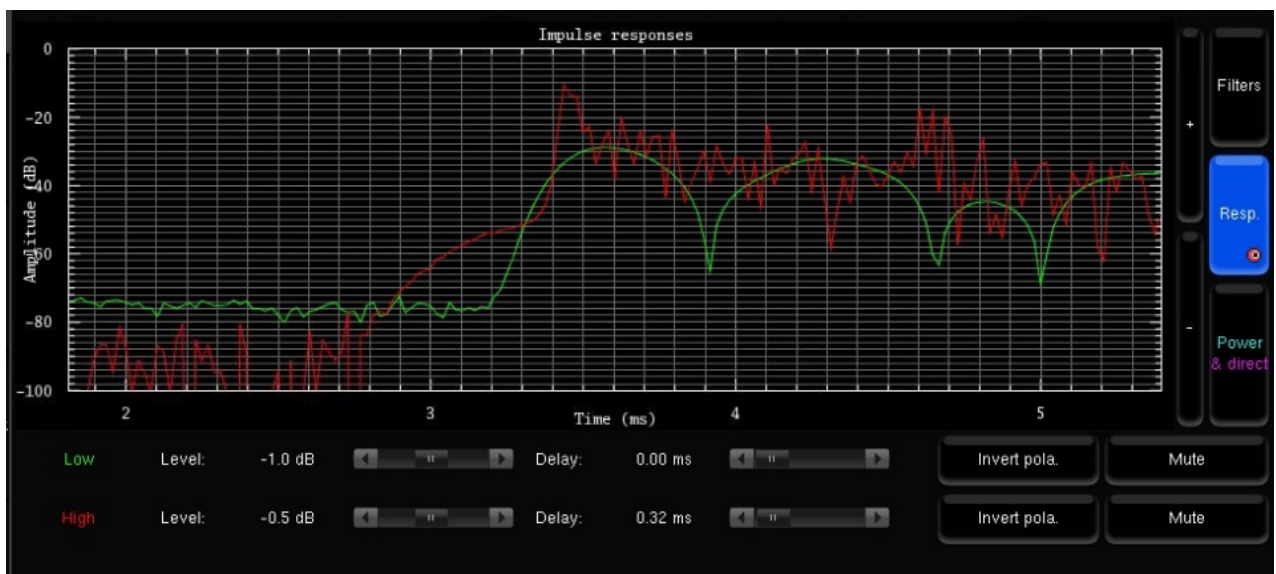

Figure 82: Measured impulse response of both drivers

- The recombined amplitude response of the speaker: You can see whether the combination of the drivers is constructive, and you can observe the effects of level/delay/polarity modification on the combined amplitude of the speaker. Two curves are displayed, one showing the total acoustic output of the speaker (including the room), and one showing the amplitude of the direct front and early reflections. Comparing both curves will indicate whether the crossover preserves the directivity of the speaker: The two curves will look more alike when the acoustic summation is optimized for the primary listening position.

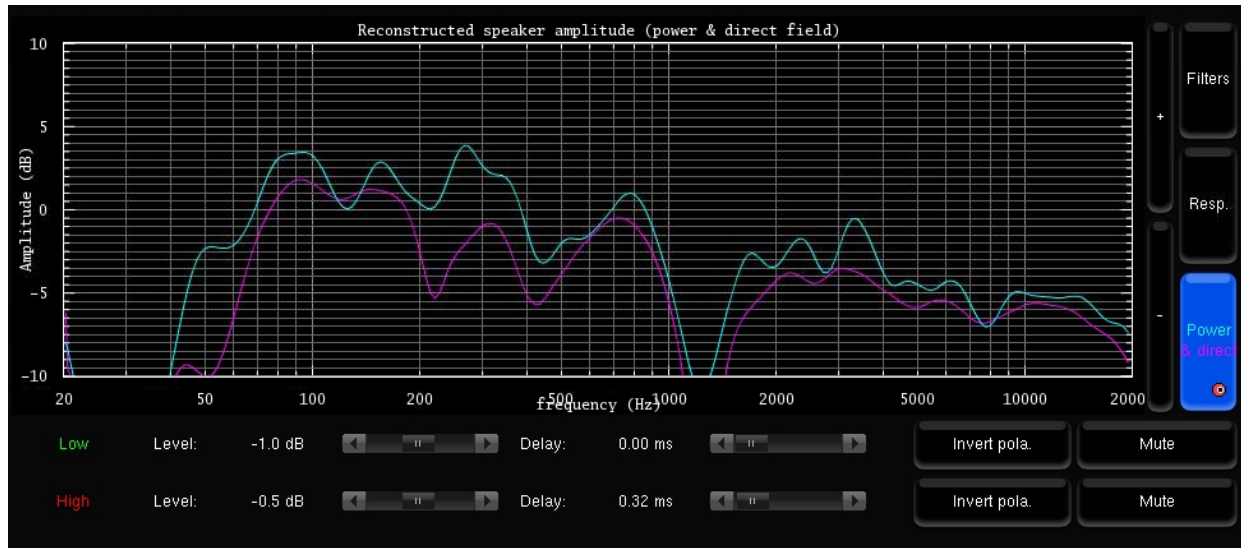

Figure 83: Recombined amplitude response of the speaker



NOTE:

- The levels, delays and polarities set previously are ignored during the calibration. In other words, adjusting these parameters before launching the calibration will have *no effect* on the result.
- Under some circumstances, the automatic crossover algorithm may suggest inverted polarities for a driver from one speaker to another. This can be explained by various factors:
 - The physical polarity of one speaker is, indeed, inverted (from a cabling issue, as an example). In this case, the correction suggested by the System should be applied to improve audio quality
 - Two adjacent drivers (for instance Mid and High) are phase-shifted by an amount of about 90°. In this case, the System provides more uncertain results, as it gets harder to see whether the drivers are in or out of phase. If you are not comfortable with the results provided by the System, you can correct them manually afterwards (via the button "Invert polarity").

12.5.2 LISTEN TO EACH SPEAKER CONNECTED TO THE CROSSOVER

Listen carefully to each speaker connected to the crossover. You can play pink noise from the SDP-75 and/or play your favorite music/cinema samples.

12.6 SAVE THE PRESET

Last but not least, don't forget to **save** the preset to avoid losing the crossover settings.

13 OPTIMIZER CALIBRATION



IMPORTANT NOTE: In order to perform a proper calibration it is important to carefully read the entire **chapters** including **Essential Tools and Settings** and **Getting Ready for Calibration** to learn about the SDP-75 audio clock settings, audio utilities (metering tools, pink noise and solo/mute buttons) and microphone placement recommendations.

13.1 OVERVIEW OF THE CALIBRATION PROCEDURE

If your speakers have been specified correctly, the calibration process is a relatively straightforward process:

1. Adjust the master output level to achieve high quality measurements;
2. Start the automated calibration: The SDP-75 will measure each loudspeaker in the room;
3. Compute the measurements;
4. Save the preset.

13.2 ADJUST THE MASTER OUTPUT LEVEL

To access the calibration page from the SDP-75 Main page:

- Click on the **Gears** button in the top menu to open the Advanced Settings user interface.
- Go to the Level and Delay Settings/Calibration page.



The system requires a minimum Sound Pressure Level for proper calibration. Until that minimum SPL is reached, the test signal will keep playing through the same speaker. For safety matters, we recommend to perform that first calibration as if it were a test.

- Set a safe output level:
 1. Decrease Master Level to -40 dB;
 2. Press the **Mute** button to cut the outputs (this step must ALWAYS be performed before pressing on the **Calibrate** button);
 3. Press the **Calibrate** button in the **Calibration** tab in the **Optimizer Settings** page of the Advanced Settings interface;
 4. Follow the on-screen instructions regarding the microphone.
- Adjust the output level:
 1. Increase the master level until the test signal moves on to the second speaker;
 2. Use the SDP-75's metering tools in the **Processor/Meters** page to check the level of the microphone inputs;
 3. Use your ears to evaluate the perceived SPL of each driver and, if possible, increase the master output level to ensure that an optimal SPL is reached for all the speakers. This will also improve the quality of your measurements;
 4. Use the **Cancel** button to stop the calibration (optional).

During this process you will need to *move back and forth* between the calibration page and the metering page:

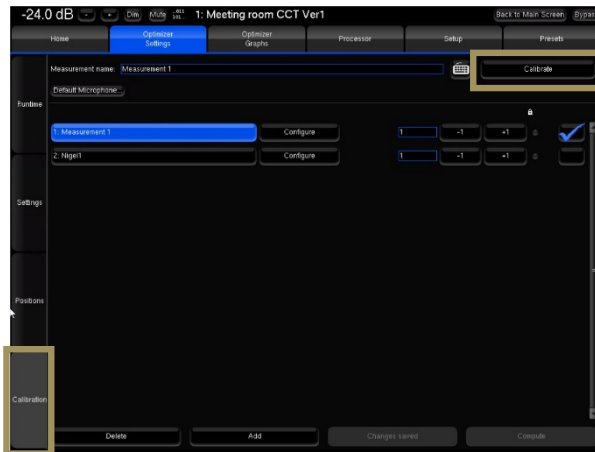

Figure 84: Calibration page

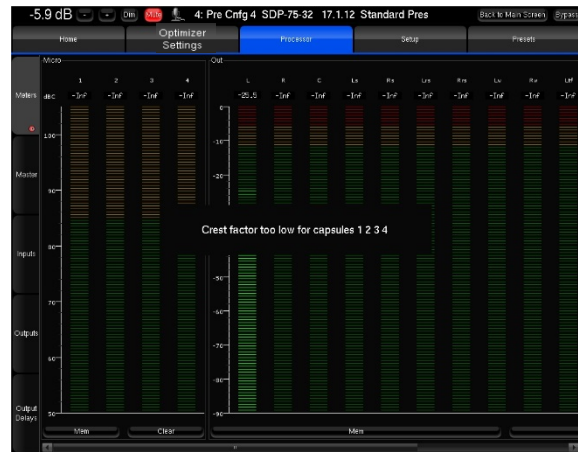

Figure 85: Metering page

13.3 NORMAL CALIBRATION SEQUENCE

Remain in the **Optimizer Settings/Calibration** page of the Advanced Settings interface to perform the final calibration:

- Follow the microphone placement instructions (see previous chapter);
- Make sure the measurement environment is silent;
- Press the **Mute** button to cut the outputs (this step must ALWAYS be performed before pressing the **Calibrate** button);
- Press the **Calibrate** button in the top right corner of the page;
- Follow the on-screen instructions regarding the microphone.



NOTES:

- The calibration tool plays three bursts for every speakers and subwoofer;
- The calibration page indicates which speaker is being calibrated.



Figure 86: The calibration page

13.4 COMMON PROBLEMS DURING CALIBRATION

If the calibration tool plays more than 3 MLS bursts for a speaker, it means that it's finding it difficult to perform a reliable measurement of that speaker.

The most common warning messages are explained below:

- "Crest factor too low for capsules":
 - Check the Input Meters in the **Processor/Meters** page.
 - If the Input level is null on at least one of the 4 channels, go back to the **Optimizer Settings/Calibration** page and stop the calibration.
 - Check that the selected analog physical input is selected in the **Home/Select** page.
 - Make sure the microphone routing is correct.
 - The microphone battery may be low. The red led at the front of the microphone indicates the battery level.
 - The microphone or cable could be damaged.
- "Unstable position for speaker":
 - Someone may have moved during the calibration.
 - Too many strong reflections around the microphone environment could be disturbing the impulse response measurement.
 - An obstacle between the microphone and any of the speakers can disturb the measurement.
 - The bandwidth of one of the speakers may be too narrow.
- "Unable to localize speaker" :
 - Dipole/bipole speakers provide more than one wave at the same time, which can cause issues.
 - Several speakers may be chained, providing more than one wave at the same time.

13.5 CALIBRATION STATUS

The calibration status has 3 possible values:

- **Yes** : If no problem occurred during the measurement. After calibration, the Top Bar indicates **NOT READY**, which means no sound can go through the processor until the optimization filters are computed.
- **Partial** : If the calibration was stopped in the middle of the measurement process.
- **No!** : When no measurement has not been performed.

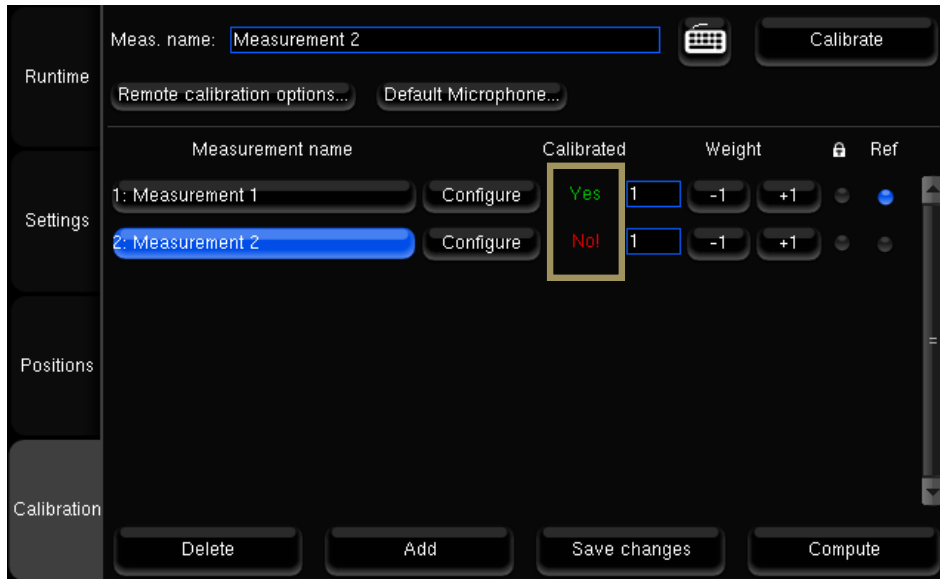

Figure 87: Calibration status

13.6 CHECKING THE SPEAKER SUMMARY AFTER CALIBRATION

The **Optimizer Settings/Positions** page displays the measured speaker locations in real-time during calibration. Three views are provided:

- **Top view:** The speakers are seen from above;
- **Elevation view:** The speakers are seen from the listening point. Relative degrees of elevation and azimuth are displayed;
- **Details view:** A table listing the measured distance, elevation, azimuth, level, delay etc.

By default, the Optimizer page always displays the reference speaker positions in green. These positions are specified in the template of the initial speaker layout (2.0, 5.1, 7.1, Atmos, Auro-3D, DTS).

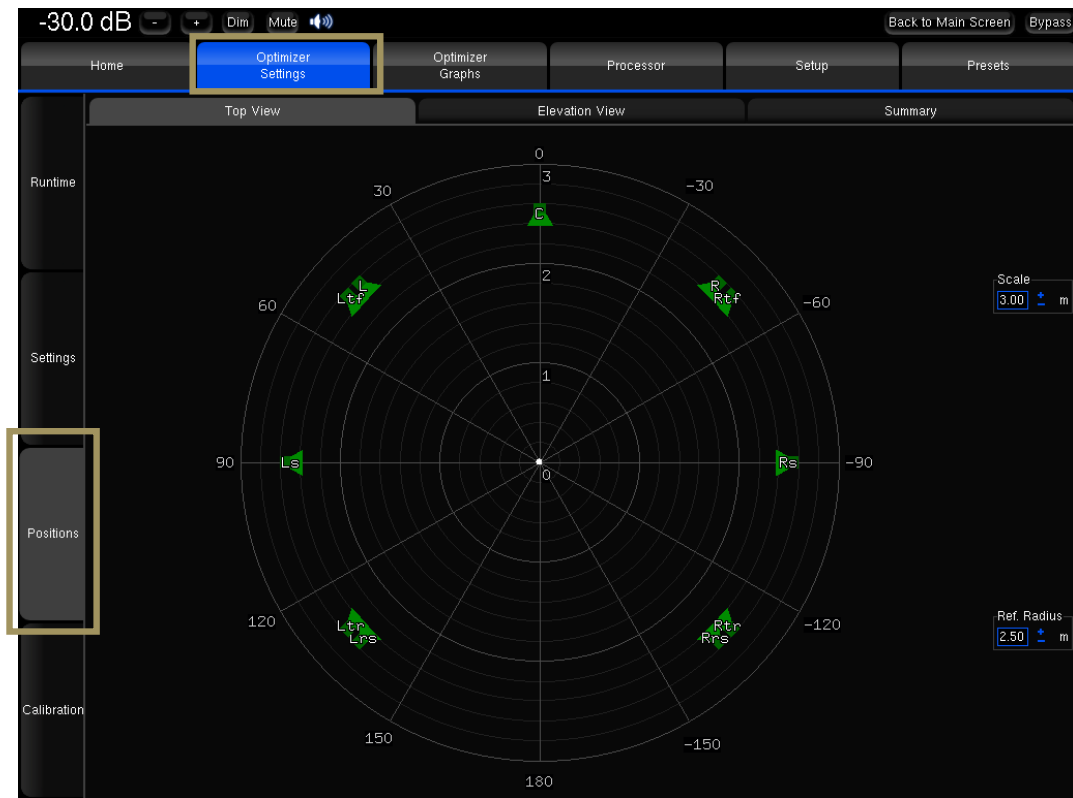

Figure 88: Top view of a 7.1.4 layout before calibration

As the calibration is performed, the real position of each speaker is displayed after the 3rd MLS burst.

The **Top View** helps to identify wrong speaker placements. It might be necessary to recalibrate if the microphone is not perfectly pointed towards the center of the front stage, but that would only impact the visual representation.

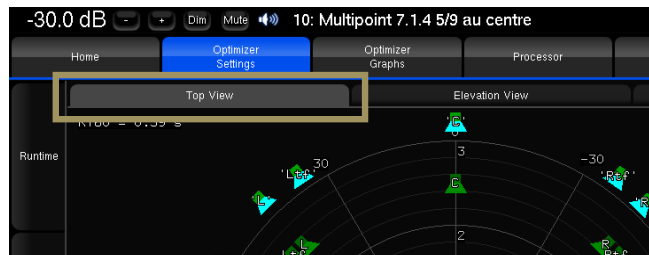

Figure 89: top view of a 7.1.4 after calibration

This view also provides the **RT60** on the top left corner of the page.

- Overlay both representations with the **Scale** and **Ref. Radius** options to verify the compliance with the recommended placements.
- The channel name displayed on each speaker is related to the channel order defined in the **Speakers/Room** setup tool.
- The color of the loudspeakers depends on the Remapping settings.
- The Elevation View uses the same color codes to display the real speaker positions. It indicates whether the microphone was or was not correctly leveled during the calibration:

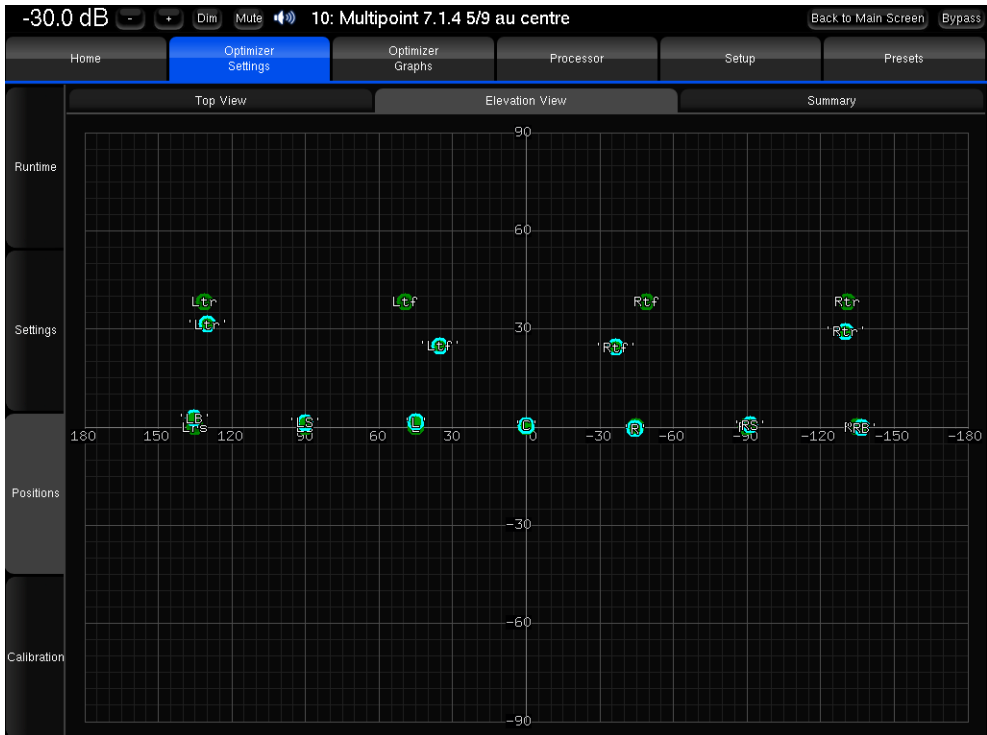

Figure 90: Elevation view of a 7.1.4 system after calibration

NOTE:

- If one speaker cannot be located during calibration, it will be displayed in the center of the circle.

The **Summary** page provides additional measurements for each speaker:

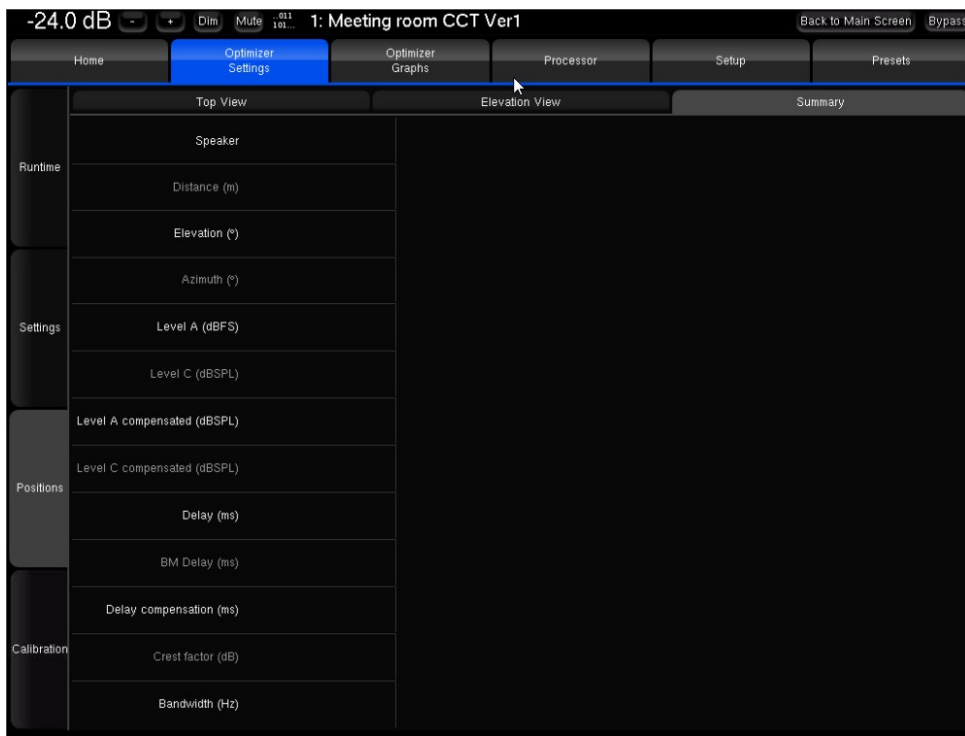

Figure 91: Speaker measurements summary

Measurement details:

- **Distance** is the distance of the speaker (in meters) to the measurement point;
- **Elevation** is the elevation of the speaker (in degrees) to the measurement point;
- **Azimuth** is the azimuth of the speaker (in degrees) to the measurement point;
- **Level A** corresponds to the A-weighted level of the speaker;
- **Level C** corresponds to the C-weighted level of the speaker;
- **Delay** corresponds to the distance of the speaker;
- **Bandwidth** corresponds to the measured bandwidth of the speaker;

Correction details:

- **Level A Compensated** corresponds to the A-weighted compensated level of the speaker;
- **Level C Compensated** corresponds to the C-weighted compensated level of the speaker;
- **Delay Compensation** is the delay that is added to every speaker to time align the system;
- **BM Delay** may be added to the subwoofer to improve the crossover with the satellites. More rarely, if the subwoofer is in advance, all the satellites are delayed;
- **Polarity** specifies whether the system will invert the polarity of the speaker. Please note this is not the "measured polarity" of the speaker;
- **Crest Factor** helps evaluating the quality of the measurement. It should be higher than 30dB. Low values could indicate background noise problems;

13.7 MULTI-POINT MEASUREMENTS (OPTIONAL)

For multipoint measurements, please see the chapter about performing multi-point measurements later in this manual.

13.8 COMPUTE THE OPTIMIZATION FILTERS

After the calibration is successfully completed, the Top Bar indicates **NOT READY**, which means no sound can go through the processor until the optimization filters are computed.



To compute the optimization filters for your speaker measurements:

- Go to the Optimizer Settings/Calibration page;
- Press the Compute button to start the calculation of the compensation filters. This will also create the Optimizer graphs.



Figure 92: Computing the optimization filters after calibration



NOTE:

- The top bar will display a **gear wheel** icon and a **graph icon** during computation.
- An onscreen message notifies the end of the computation.
- The **speaker** icon indicates that the Optimizer is ready.
- Computation time varies depending on the number of speakers in the system and on the Optimizer parameters.



IMPORTANT NOTE:

- Once the speaker system has been calibrated, all changes will be applied by recalculating the filters by pressing the **Compute button**.
- Performing new measurements is not required unless:
 - Speakers/Furniture/listening positions change in the room;
 - the active crossover filters are modified;
 - The number of speakers is modified;
 - The channel order is modified.

13.9 SAVE THE PRESET

Last but not least, be sure to save the preset to make sure all your preferred measurements and computed filters are not lost.

14 SETUP BASS MANAGEMENT

This chapter explains how to setup bass management in the SDP-75.

The SDP-75 provides very flexible options that help you to optimally configure the bass management of your system. You can specify how the lower frequencies of each channel will be reproduced by one or more subwoofers.

In other words, individual speakers can be bass-managed with any combination of subwoofers and specific crossover frequencies.



NOTE:

- The SDP-75 supports **any number of subwoofers** as long as enough physical outputs and processing channels are available, therefore allowing for a maximum flexibility in the speaker system design.
- Bass Management can be activated even if the system has not been calibrated. However, the automatic time-alignment of the subwoofers is only performed after a calibration of the whole set of speakers

IMPORTANT NOTE:

- For optimal results, the bass management should be setup *manually* based on the *acoustic measurements* of the speaker responses in the room.
- The Bass Management results do not impact the Optimizer graphs.

14.1 OVERVIEW OF THE BASS MANAGEMENT SETUP PROCEDURE

The recommended bass management setup procedure is as follows:

- Analyze the acoustical graphs of the speaker measurements in order to understand the low frequency response of each speaker in the room;
- Decide whether bass management is necessary or not. It is always necessary when using one or more subwoofers.
- To activate bass management:
 1. Identify the High Pass Frequency that seems appropriate for each channel. 80 Hz is usually the best choice.
 2. Configure the bass management options (Off, On, On + Lfe to lr);
 3. Configure each channel to be bass-managed by one or more subwoofers.
- Last but not least: Save the preset.

The Bass management is divided into 3 different sections represented as 3 tabs which will be detailed in the following chapter:

- **Quick Setup:** The Quick Setup is the default section of the Bass Management. It allows a global configuration by applying values on several speakers and subwoofers simultaneously (It is not enabled if Bass-Management is Off);
- **Individual Setup:** The Individual Setup provides the ability to adjust the settings on each speaker and sub individually (It is not enabled if Bass-Management is Off);
- **LFE & Misc:** This section allows adjustment of the LFE gain, polarity, Low-pass filter type, Low-pass frequency, slope, as well as enabling the standard +10dB LFE input and stacked sub correction.

The Bass Management page is accessible through the Top Menu of the SDP-75 User Interface:

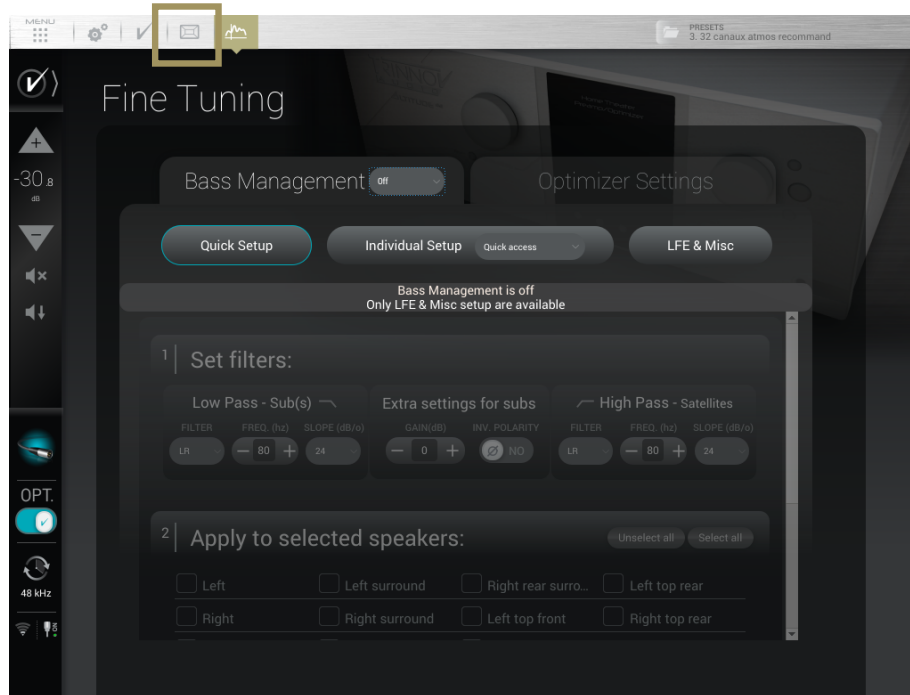

Figure 93: Access to the Bass Management options

•

14.2 FULLY CUSTOMIZABLE BASS MANAGEMENT

The SDP-75 allows you to specify how the lower frequencies of each channel will be reproduced by one or more subwoofers. For every speaker you can:

- Specify a High Pass Frequency;
- Activate one or more subwoofers that will reproduce the lower frequencies from that channel;
- Setup the gain for each subwoofer;
- Invert the polarity for each subwoofer.

This is different from the majority of the currently available AV surround preamplifiers which offer relatively simple bass management features. They usually allow you to choose from only two types of speakers: "large" or "small", and have predefined parameters for the bass management filters.

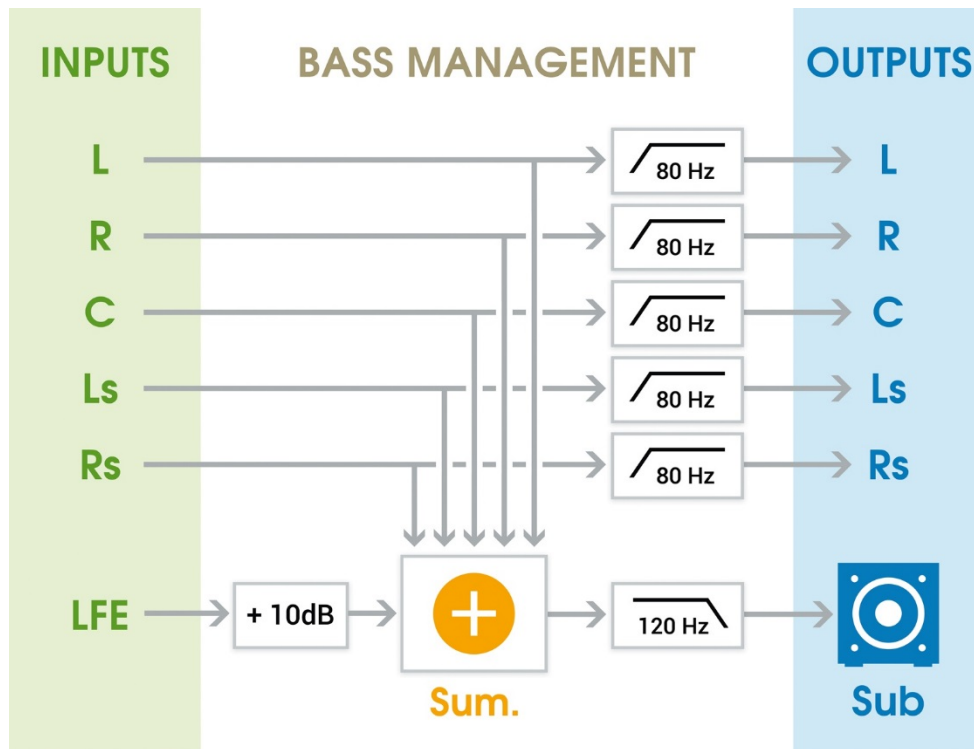

Figure 94: Typical bass management in a standard surround preamplifier

14.3 BASS MANAGEMENT MODE

The SDP-75 offers 3 different bass management modes:

- **Off:** No bass management (default)
- **On:** Standard bass management mode, which is recommended for all installations utilizing subwoofers.
- **On + LFE to LR:** Distributes the LFE signal to the Left and Right speakers. Can be used when there is no subwoofer in the system. **Note that in this mode, if a subwoofer is declared, the LFE will not be played by this subwoofer. This mode is rarely recommended.**

Those modes are accessible from dropdown menu as shown below:

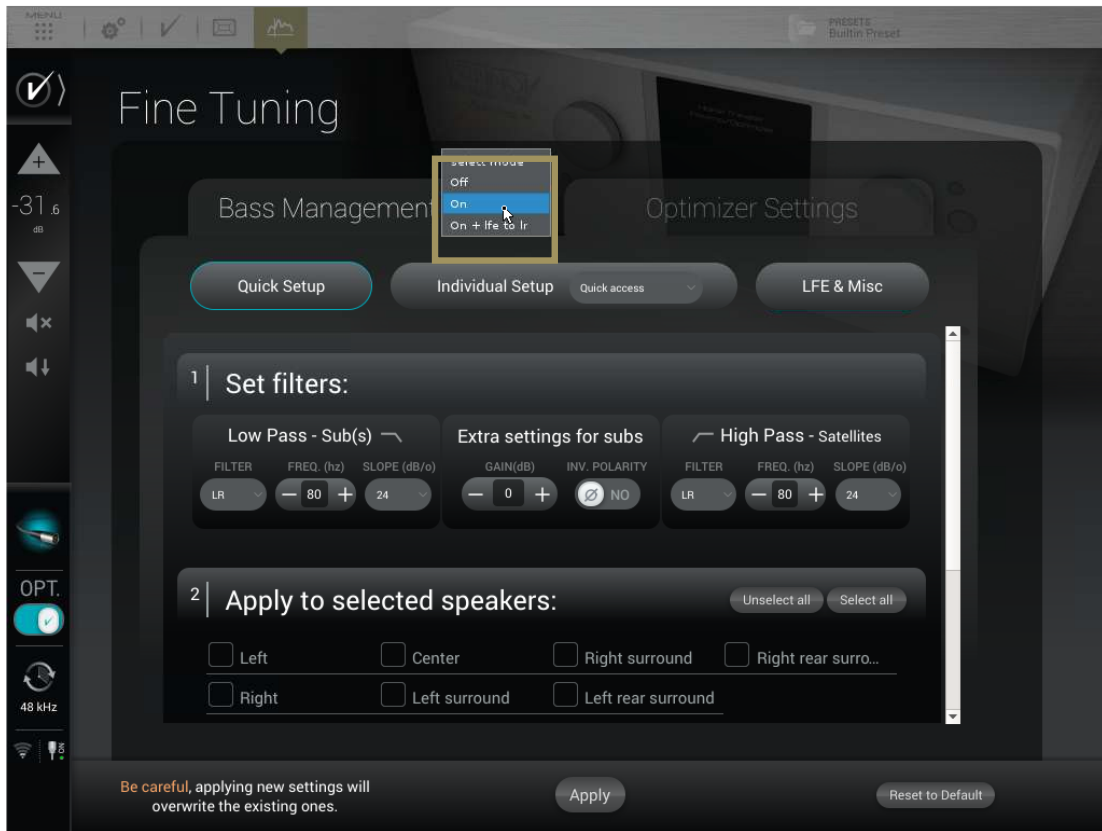

Figure 95: Access to the Bass-Management options

14.4 QUICK SETUP MENU

The Quick Setup menu is a powerful tool allowing to configure the bass management for several speakers all at once.

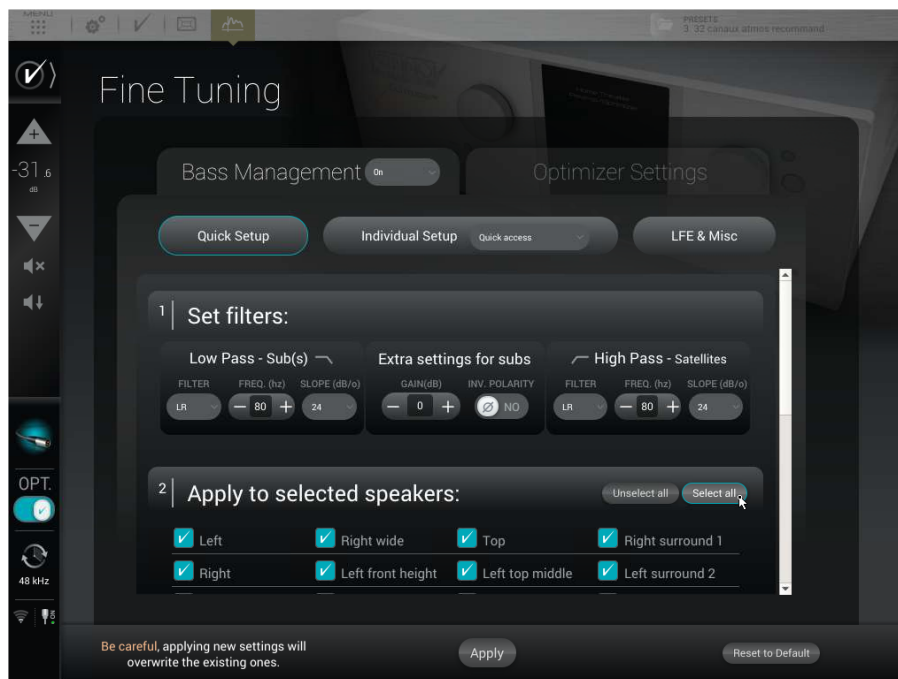

Figure 96: Bass Management Quick Setup

The Quick Setup menu is divided into 3 main section:

1. **Set Filters:** This section is to specify the filter type and frequency that will be applied;
2. **Apply to selected speakers:** Here, you can select the speakers on which you can apply the filters selected in the first section;
3. **And apply to associated sub(s):** Select the sub(s) associated to the group of speakers and filters.

The 3 sections are detailed in the sub-chapters below.

The configuration steps are the followings:

- Enter the desired settings in the **1| Set filters** table;
- Select the speakers on which you want to apply those settings on the **2| Apply to selected speakers** section;
- Select the associated sub(s) in the **And apply to associated sub(s)** section;
- Press on the **Apply** button to validate;
- Do the same for another group of speakers and sub if needed;
- Listen and adjust if needed;
- Save the preset.



NOTE: It is not possible to apply the settings if no subs are selected. This means that you cannot disable bass management on several speakers at the same time with the Quick Setup menu. To do so, please use the **Individual Setup** described in the next sub-chapter.

14.4.1 SET FILTERS

As shown below, this first section is divided in 3 different groups of settings:

- **Low Pass – Sub(s)** : These settings will define the cutoff frequency under which the signal from the channel will be redirected and played by the subwoofer(s). You can select the type of filter (Linkwitz-Riley, Bessel or Butterworth), the cutoff frequency and the slope used by this filter. These settings only apply to the signal redirected to the subwoofer(s).
- **Extra settings for sub(s)**: These additional settings give the possibility to invert the polarity and adjust the gain of the signal that is redirected to the subwoofer(s). These settings only apply to the signal redirected to the subwoofer(s).
- **High Pass – Satellites**: This section will define the low-end cutoff frequency of the signal send to the satellites. You can here select the type of filter (Linkwitz-Riley, Bessel or Butterworth), the cutoff frequency and the slope use by this filter. These settings are apply to the signal redirected to the Satellites. 80 Hz, with a 24 dB or greater slope is generally advised, unless some of the satellites could be damaged if extended to 80Hz. In such cases, **Individual Setup** should be used.

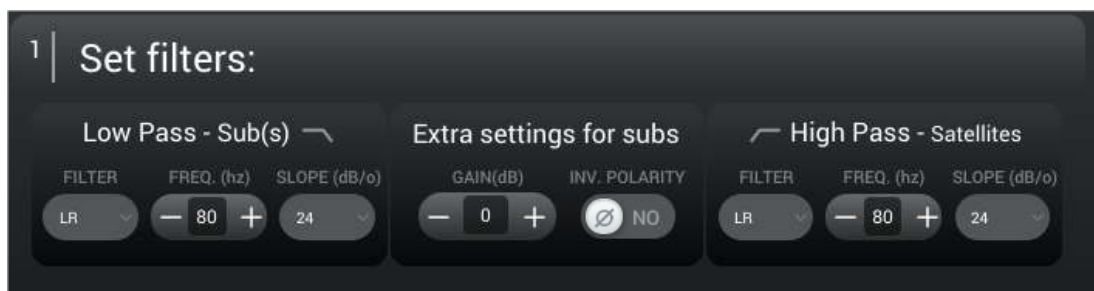

14.4.2 APPLY TO SELECTED SPEAKERS

The second section is here to define the group of speakers on which the filters will be applied. The speakers, or satellites, are only affected by the High Pass filter. The speaker selection is done by checking the box on the left side of each speaker's name.

Two buttons are in the Top right corner of this second section:

- **Unselect all**: Clicking on this button unselects every speaker;
- **Select all**: Clicking on this speaker selects every speaker.

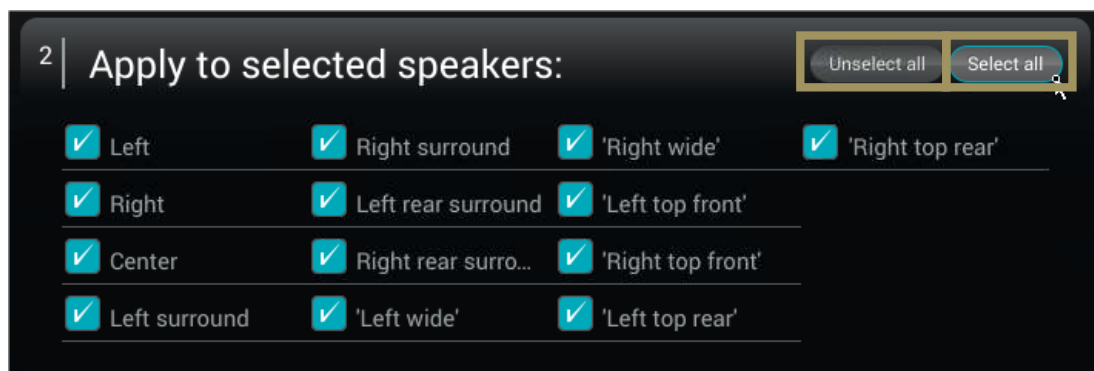

14.5 BASS MANAGEMENT SETTINGS FOR INDIVIDUAL SPEAKERS

The settings provided are similar to the **Quick Setup** menu but are adjustable on each speaker individually. Each speaker has the following parameters:

- The activation of each sub by checking the **Active** box (which recalculates the attenuation accordingly): The bass-managed signal will be redirected to the selected subwoofer(s);
- **Gain and Polarity** These additional settings provide the option to invert the polarity and adjust the gain of the signal redirected to the subwoofer(s). These settings are only applied to the signal redirected to the subwoofer(s), the signal going to the speaker remains unchanged;
- **Low Pass – Sub(s)** : These settings will define the cutoff frequency below which the signal from the channel will be redirected and played by the subwoofer(s). You can select the type of filter (Linkwitz-Riley, Bessel or Butterworth), the cutoff frequency and the slope used by this filter. These settings are only apply to the signal redirected to the subwoofer(s);
- **High Pass – Satellites**: This section will define the low-end cutoff frequency of the signal sent to the satellites. You can select the type of filter (Linkwitz-Riley, Bessel or Butterworth), the cutoff frequency and the slope use by this filter. These settings are only apply to the signal redirected to the Satellites.

 **NOTE:** Bass Management mode must be set to **On** in order for these settings to be taken into account.

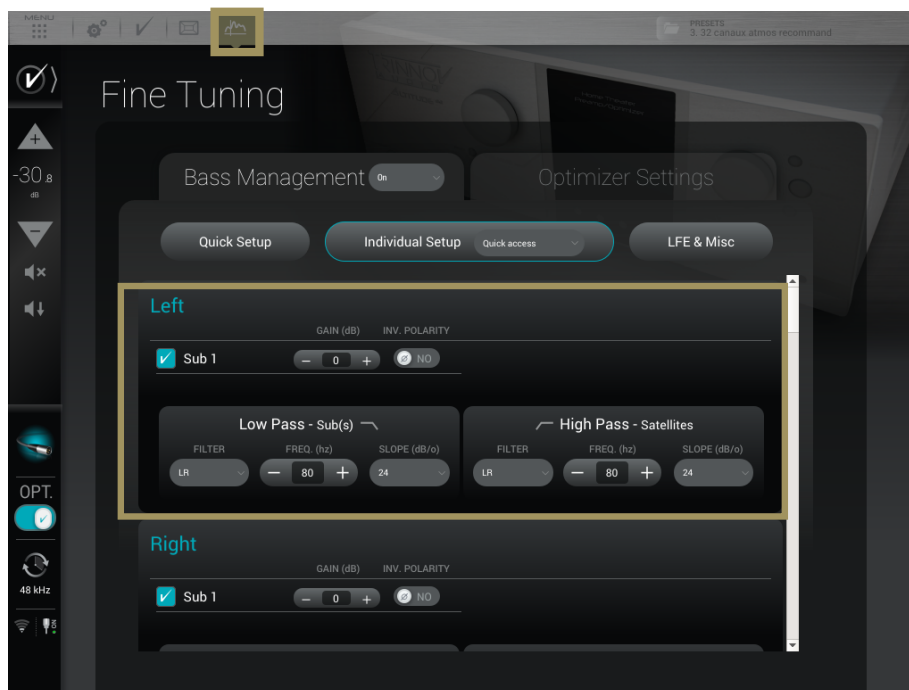



Figure 97: Configuring the bass management settings for every speaker

 **IMPORTANT NOTE:** If there is no active sub for one or more satellite, the high-pass frequency is still active. If a full-range speaker is needed, set the **High-Pass** filter type to **None** and it will disable the filter.

14.6 LFE & MISC

The **LFE & Misc Setup** page is active even if the Bass Management is Off. These parameters only impact the subwoofer(s).

LFE stands for “Low Frequency Effects,” and is an optional channel that may or may not be present in source material, and which is the “x.1” channel. LFE signals should always be reproduced by subwoofer(s).

The page is divided as followed:

- A table allowing the assignment of the LFE channel of the content, if present, to one or more subwoofer(s)
- A **Low Pass – LFE** section to set a filter on the LFE channel
- A **Misc.** section with various options

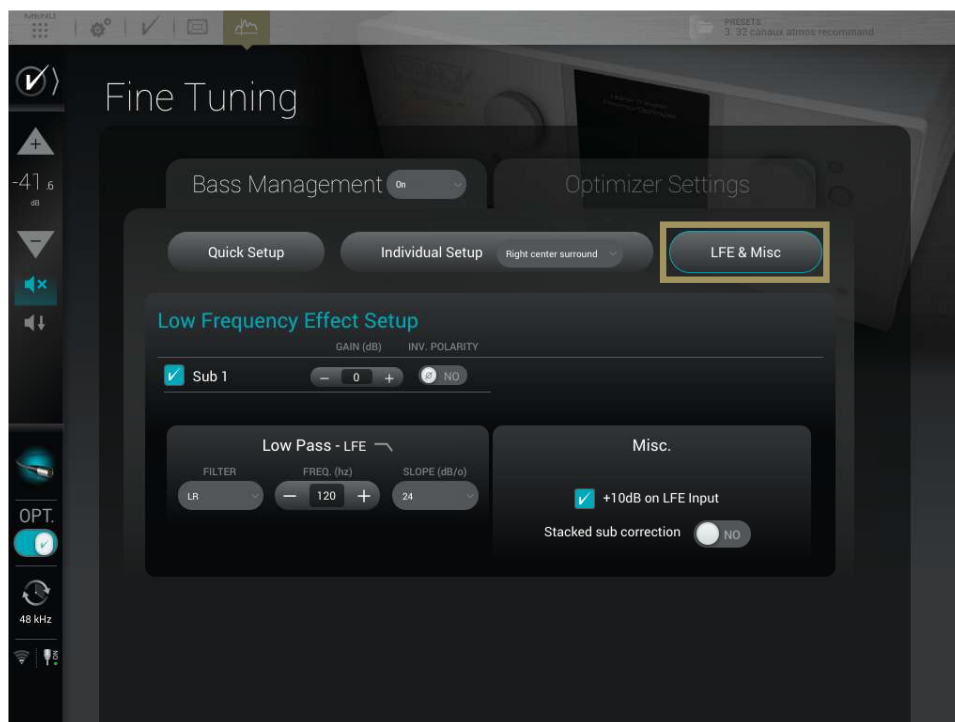

Figure 98: LFE & Misc page

14.6.1 LOW FREQUENCY EFFECT SETUP

This first section is here to choose which subwoofer is assigned to the LFE channel. A subwoofer assigned to the LFE will play the .1 of the content.

To assign the LFE channel to a subwoofer, please tick the box of the desired subwoofer.

The LFE signal can be filtered. A Low Pass filter is available and only apply on the LFE channel (not on the subwoofer(s) assigned).

Low Pass – LFE: This setting will define the cutoff frequency of the LFE channel. You can select the type of filter (Linkwitz-Riley, Bessel or Butterworth), the cutoff frequency and the slope used by this filter.

14.6.2 +10 DB ON LFE

Unless the encoded bitstream signal is decoded upstream by another device, the **+10dB on LFE input** option should be enabled (default). It applies a gain of 10dB on the incoming LFE signal. The default is almost always the correct setting.

14.6.3 STACKED SUB CORRECTION

The **Stacked subs** option is designed for stacked multiple-subwoofers configurations.

When multiple subwoofers are used to reproduce the same signal, the perceived level increases. The SDP-75 automatically decreases the signal sent to each subwoofer to maintain the same perceived level depending on the number of subwoofers used to reproduce the same signal. The attenuation varies, depending upon whether the subwoofers are located very close to each other, or are located well-away from each other, which is typically the case.

In such multiple subwoofers configurations, two typical cases are handled by the SDP-75:

- If subwoofers are considered as decorrelated (away from each other), their power add up.
- If subwoofers are considered as correlated (positioned next to each other or stacked), their amplitude add up.

Therefore, whether the stacked subs option is disabled (default) or enabled, an automatic attenuation of the signals will be calculated accordingly to maintain a consistent level.

Number of subwoofers in the system	Attenuation if "Stacked subs" disabled	Attenuation if "Stacked subs" enabled
2 subwoofers	-3 dB	-6 dB
3 subwoofers	-4.8 dB	-9.5 dB
4 subwoofers	-6 dB	-12 dB

Figure 99: Level of attenuation and the Stacked Subs option

15 SETUP TARGET CURVES

The SDP-75 implements Target Curves as a powerful tool for achieving the required frequency response from your system. For every speaker in the room, a target curve can be defined in terms of:

Amplitude only / Amplitude and Phase / Amplitude and Group Delay

One or more channels can be linked in order to share the same target curve for several speakers.

15.1 OVERVIEW OF THIS PROCEDURE

In the SDP-75, setting target curves is a very straightforward procedure:

- Decide if you want to apply the same target curve to all the speakers (except subwoofers), or if you want to apply a different target curve depending on the type of speaker.
- Link/unlink the speakers that will share the same target curve.
- Setup the target curve for each group of speakers.
- Press the **Apply Change** button.

15.2 SETTING UP ONE OR MORE TARGET CURVES

To edit the target curve for one or more speakers, go to the **Optimizer Settings/Target Curve** page in the Advanced Settings user interface:

The most usual case is to link all the speakers except the subwoofer(s). Therefore, by default, the Link button is activated for all the speakers except for the subwoofer(s). If this is not the case, you can press the **Link all but Sub** button.

Use the arrow keys of your keyboard or you mouse to edit the target curve:

- The **green dots** correspond to the required values for each frequency,
- The **yellow line** displays the expected result, taking into account the behavior of the filter.

Press the **Apply Changes** button. This button becomes orange as soon as you change some setting that requires a new computation of the optimization filters.

Save as a **new** preset. This will allow you to compare the sound with and without the target curve.

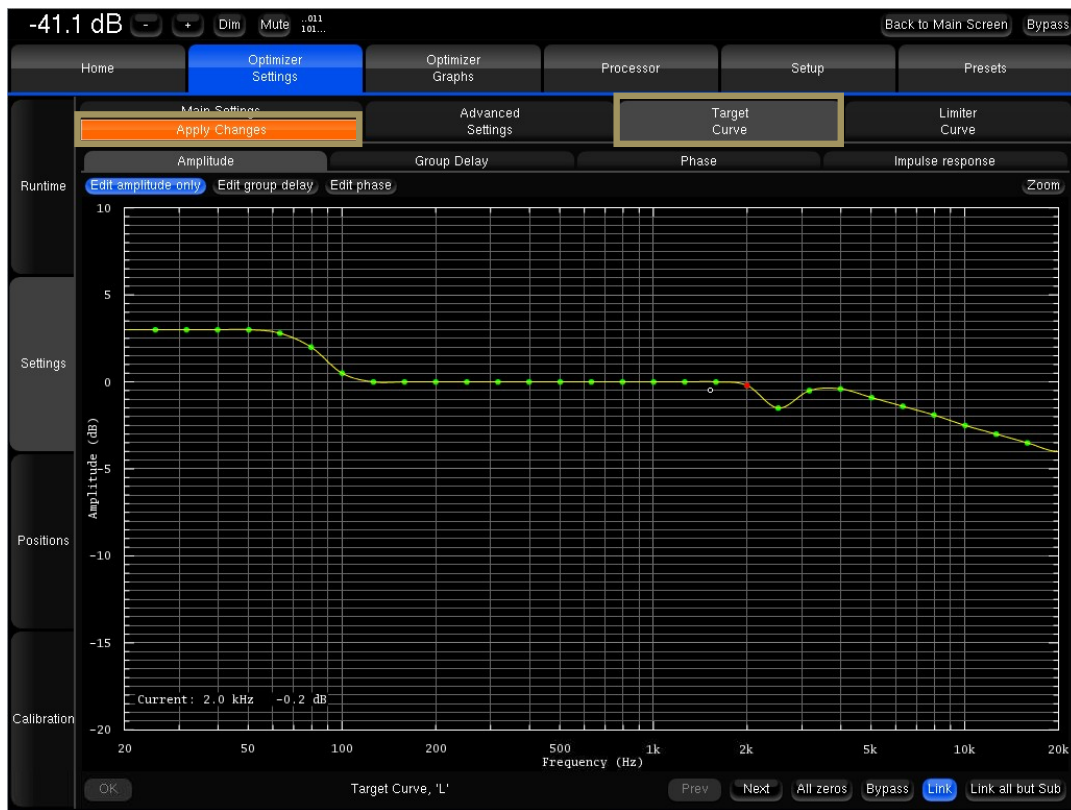

Figure 100: Example of a Target Curve in the Advanced Settings user interface



NOTE:

- By default, the Optimizer will use both IIR and FIR filters to achieve the target curve.
- In addition to target curves, several other parameters define the behavior of the automatic equalization.

16 VERIFY THE SOUND OF YOUR OPTIMIZED SPEAKER SYSTEM

Once you have completed all the steps of the system setup procedure, it is *critically important* to verify the sound of the entire system. This should help you to identify any possible issues:

- Look at the acoustical graphs of all the speakers;
- Listen to the system.

After all possible issues have been corrected, you will be confident that the system is ready to deliver the best home theatre experience available today.

16.1 VISUALIZE THE ACOUSTICAL GRAPHS FOR ALL SPEAKERS

Go to the **Optimizer Graphs** page and visualize the acoustical graphs of one or more speakers.

Depending on your observations, you may decide to change the target curves, the bass management settings, or some of the more advanced optimization settings. See the *next chapter* for a detailed explanation of the comprehensive fine tuning options offered by the SDP-75.



Figure 101: Visualizing the acoustical graphs for the whole system

16.2 LISTEN TO THE SYSTEM

Most importantly, listen carefully to your system by playing your favorite music and cinema samples. As an option, you could also play pink noise from the SDP-75 to perform additional acoustical measurements with your own acoustical measurements tools.

17 FINE TUNING OPTIMIZATION SETTINGS

In order to tune the optimization settings you need to know the basics about the SDP-75's audio tools and settings. You will be using those tools throughout the tuning process for:

- Playing pink noise on the speakers
- Solo/mute inputs or outputs
- Switching optimization on/off
- Viewing the acoustical graphs.

For a detailed explanation of all those tools, please refer to the *Essential Tools and Settings chapter*.

17.1 MAIN OPTIMIZATION SETTINGS

The Optimizers Main Settings are located in the **Optimizer Settings/Settings/Main Settings** page.



NOTE: Changes made in the Optimizer Settings do not require new acoustic measurements. The new compensation filters are recomputed on the fly using the **Apply changes** button.



Figure 102: Main optimization settings

- **Optimize** (Optimization Modes): The SDP-75 offers four different optimization modes with very specific behavior:
 - **Amplitude + Phase** (default): With this setting, the Optimizer will improve both the loudspeaker amplitude and the phase response of the loudspeaker. This greatly reduces the group delay of the speakers starting from about 150Hz.
 - **Amplitude only**: This mode tells the Optimizer to work only on the amplitude of the loudspeaker's response. The phase behavior is not modified;
 - **Low range only**: With this setting the automatic equalization will only use IIR filters up to the frequency defined in the advanced settings (Default: 150Hz). The automatic FIR filter is disabled, but manual FIR EQ can still be applied;
 - **According to L&R speakers**: This is a special mode that will optimize the other speakers in order to achieve the same response as the averaged Left+Right speakers. The different options available for this mode are explained in the Advanced **Optimization Settings subchapter**.

- **Maximum Boost/Attenuation**:
 - **Maximum boost**: defines, in dB, the maximum amount of boost that will be performed by the algorithms. This parameter is used to avoid distortion. Its default value is 6dB.

This parameter has an important impact on the behavior of the automatic equalization, and is applied to both the time-based and the amplitude-based approach.
 - **Maximum attenuation**: defines, in dB, the maximum amount of attenuation that will be performed by the algorithms. Its default value is -10dB.

This parameter also has an important impact on the behavior of the automatic equalization, and is applied to both the time-based and the amplitude-based approach.

See also the **Limiter Curve** functionality described below.

- Acoustic parameters "Quantity of Early Reflections" and "Resolution of Energy Response": The SDP-75 uses two different approaches for the Optimization of Loudspeaker/Room Acoustics:
 1. A time-based approach for the correction of Early Reflections (ER). The main parameter that defines the behavior of this algorithm is the width of the time-frequency window "Quantity of Early Reflections".
 - **Quantity of Early Reflections** (default is 3 cycles): A simple parameter that characterizes the quantity of early reflections that the Optimizer tries to compensate is the width of the time-frequency window. The size of this window is defined by a number of *cycles*, hence the naming " α/f ", where α (*alpha*) is the number of cycles and f the frequency ($1/f$ being one cycle).
 - The meaning of the time-frequency window is as follows: for each frequency a different duration (or *width* of the time window) is taken into account. At low frequencies the window typically starts at 150ms for 20Hz, and decreases constantly to be as low as 0.3ms at 10 kHz.
 2. An amplitude-based approach for the correction of Late Reverberation (LR), whose main parameter, Resolution of Energy Response is the smoothing applied to the energy response.
 - **Resolution of Energy Response** (default is 1/3 octave): It defines, in number of octaves, how the room's energy response is smoothed, and modifies the behavior of the equalization performed by the Optimizer on the *Late Reverberation*. Its default value is 1/3 octave.
 - The behavior of the energy optimization algorithm varies according to the *smoothing* applied to the room response. If the response is less smoothed, sharp peaks in the response will be more taken into account for the correction, while with more smoothing only the overall tonal balance of the room will be corrected.

17.2 TARGET CURVE

Please see the **Setup Target Curves** chapter.

17.3 LIMITER CURVE

Unlike the **Maximum Boost/Attenuation** parameters, the limiter curve allows to setup *frequency-dependent* maximum boosts and attenuations. This curve is not engaged by default.

To define a specific limiter curve, go to **Optimizer Settings/Settings/Limiter Curve**:

- Use the **Add point mode** and your mouse to create editing points around the required frequency range.
- Use the **Move point mode** and your mouse to edit the limiter curve for the required frequency range.
- Use the **Delete point mode** to delete editing points with your mouse.
-



IMPORTANT NOTE: Very steep curves should be avoided.



NOTE: Editing the maximum boost and maximum attenuation limiter curve disables the global Maximum Boost/Attenuation settings in the Optimizer Main Settings page.

In the example above, the limiter curve will avoid too much attenuation below 100 Hz.

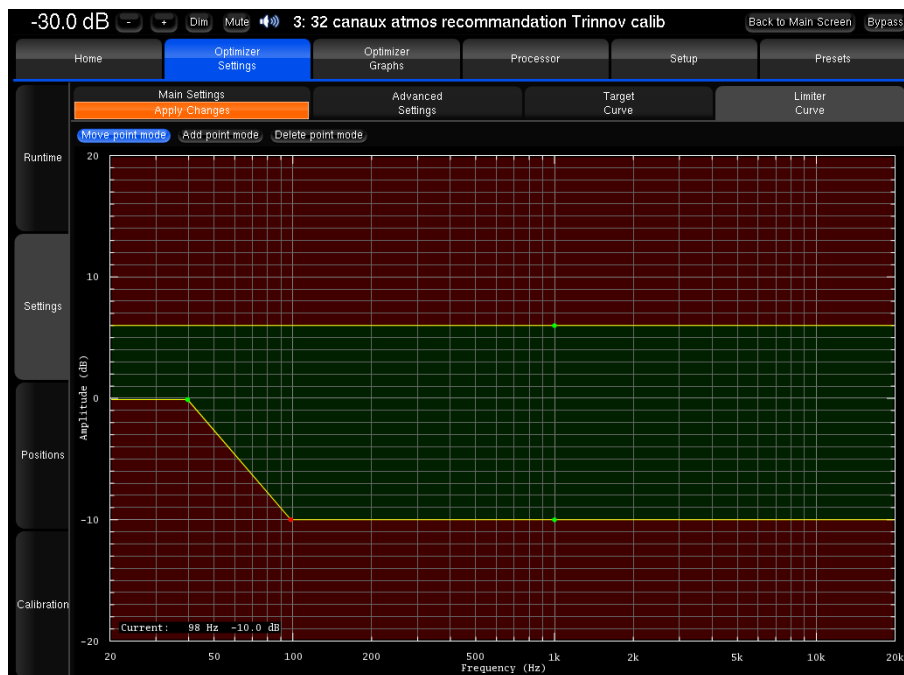

Figure 103: example of a limiter curve for maximum boost/attenuation

17.4 ADVANCED OPTIMIZATION SETTINGS



IMPORTANT NOTE: Change these settings from the recommended settings only if you know what you're doing. Random changes can lead to unexpected results.

The SDP-75 provides a large set of advanced settings in the **Optimizer Settings/Settings/Advanced Settings** page:

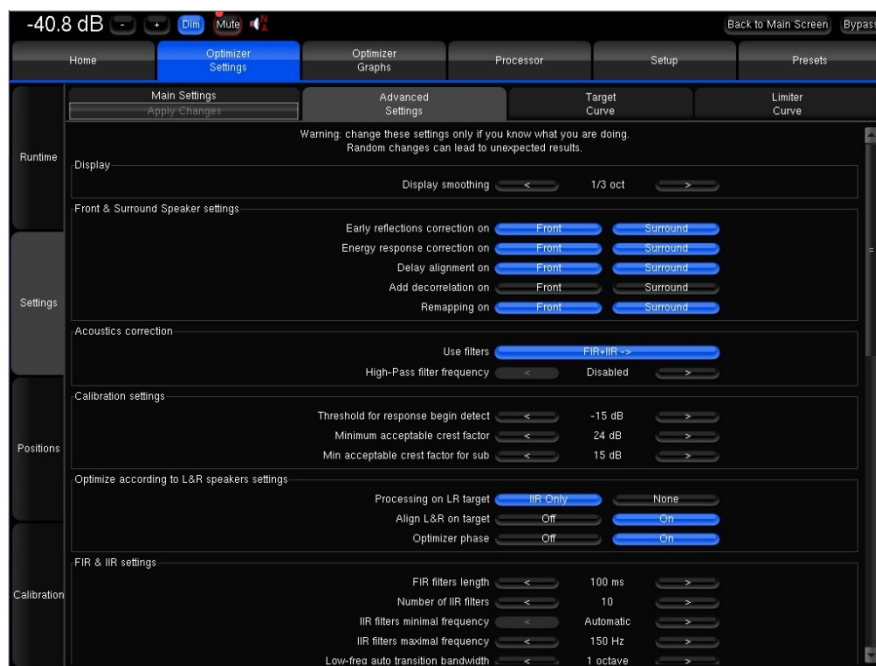

Figure 104: Advanced optimization settings

17.4.1 DISPLAY

The **Display smoothing** defines the smoothing value used to display the before and after Amplitude Response in the Optimizer Graphs as well as **in the pdf document** generated while saving preset. Its default value is (1/3 octave). A smaller value, such as 1/12 octave, can be used to display more details in the frequency response.

17.4.2 FRONT & SURROUND SPEAKER SETTINGS

The following features can be separately enabled/disabled for the front speakers and for the surround speakers:

- Early reflections correction;
- Energy response correction;
- Delay alignment, e.g. surround delay alignment may or may not be required depending on the application and recommendations;
- Add decorrelation: the Optimizer can apply a decorrelation algorithm to the surround channels in order to simulate the diffuse field created by a belt of surround speakers;



NOTE: Front speakers are defined as those whose azimuth is below 90 degrees. Conversely, Surround speakers are defined as those whose azimuth is above 90 degrees.

17.4.3 ACOUSTICS CORRECTION

The user can determine the type of filters for the automatic correction:

- **FIR + IIR:** This is the default setting used by the Optimizer: Both IIR and FIR filters are used to work on the speaker responses full range;
- **FIR only:** No IIR filters are used, which means that the Optimizer will only work on the mid and high range of the speaker responses. The low range will not be optimized;
- **IIR only:** With this setting, both the automatic FIR and the FIR EQ are disabled. The Optimizer will only use IIR filters to work on the low range. This setting could be used in specific cases where the user wants to be sure that no FIR filters at all are applied.
- **High-pass filter frequency:** Defines the cutoff frequency for the high-pass filter applied to all channels. Can be disabled.

17.4.4 CALIBRATION SETTINGS

- **Threshold for "resp" begin detect:** The threshold below the peak level of the impulse that is taken into consideration to determine the onset of the response. -15 dB is the default value and works in most cases. However, a lower threshold is recommended in a room with a huge amount of early reflections where the peak might not be detected correctly.

17.4.5 OPTIMIZE ACCORDING TO L&R SPEAKERS SETTINGS

The Optimizer mode "According to L&R speakers" can be configured with specific settings:

- **Processing on L&R target** (Default is IIR only): If the optimize mode is set to "Optimize according to L&R speakers" in the main settings tab, the Optimizer only uses IIR filters on the L&R speakers. This can be switched to "None" to make sure the L&R speakers are not optimized at all.
- **Align L&R on target** (Default is On): If this setting is on, the Optimizer applies filters on the Left & Right speakers using their average response as target. If this setting is off, only the center and surround channels are optimized.
- **Optimizer Phase** (Default is On): Determines whether the Optimizer should optimize the phase response of the speakers or not when the L&R speaker mode is on.

17.4.6 FIR AND IIR SETTINGS

FIR stands for Finite Impulse Response. FIR filters are used to optimize amplitude and/or phase.

IIR stands for Infinite Impulse Response. IIR filters are minimum phase filters used by the automatic compensation, in addition to FIR, for the low frequencies.

- **FIR filter length** (default is 100ms): Defines the length or number of taps of the FIR filter. The longer the FIR filter, the higher resolution the correction.
- **Number of IIR filters** (default is 10): The number of IIR filters that will be used on every channel.
- **IIR filters minimal/maximal frequency** (default is Automatic/150Hz): IIR filters will be positioned from the min frequency up to the max frequency. The Automatic parameter uses the minimum frequency of the speaker bandwidth and the Low-freq auto transition bandwidth parameter to calculate the IIR filter minimal frequency.
- **Low-freq auto transition bandwidth** (default is 1 octave): Determines the bandwidth of the auto transition. The auto transition is the frequency range that separates the Optimized frequency range from the unfiltered frequency range in the low end. The upper boundary of this auto transition bandwidth is the minimal frequency of the speakers bandwidth.
- **Room smoothing method** (default is Modulus): For advanced users only.
- **Norm used for level_hp (!= align)** (default is Room): For advanced users only.

17.4.7 LEVEL ALIGNMENT SETTINGS

- **Weighting used for levels** (default is dBA): Sets the type of weighting used by the optimizer for level alignment.
- **Width of level window** (default is 16/f): This time-frequency window is used to compute the perceptual level of every speaker. Its width can be modified to improve the automatic level alignment.
- **Maximum/minimum gain on speakers** (default is 10dB/-20dB): defines the maximum/minimum gain that will be applied for the automatic level alignment.
- **Minimal/maximal bandwidth frequency** (default is 10Hz/Unlimited): defines the high end/ low end of the bandwidth that is used as the starting point for level computations.
- **Bandwidth determination mode** (default is Normal): Defines the speakers automatic bandwidth determination mode from measurements.

17.4.8 SUBWOOFER LOW-PASS FILTER SETTINGS

The Optimizer includes a subwoofer low-pass filter with the following options:

- **Cutoff frequency** (Default is "disabled"): Defines the cutoff frequency for the low-pass filter that can be applied to the subwoofer.
- **Filter type** (Default is Butterworth): Defines the type of filter used at the cutoff frequency. The elliptic filter is sharper than the Butterworth but shows ripples in the whole bandwidth.
- **Filter order** (Default is 4): Defines the steepness of the filter. The slope gets stiffer as you increase the filter order. Please be aware that such changes may result in significant phase shifts
- **Rp value** (For elliptical filter) (default is 0.1 dB): Sets a maximum amplitude ripple above the cutoff frequency.
- **Rs value** (For elliptical filter) (Default is 80 dB): Defines the attenuation below the cutoff frequency.
-

17.4.9 DECIMATION SETTINGS & ADVANCED FIR SETTINGS



IMPORTANT NOTE: It is strongly recommended not to change these settings unless you have been requested to do so by JBL Customer Support.

17.4.10 ADVANCED FIR SETTINGS



IMPORTANT NOTE: It is strongly recommended not to change these settings unless you have been requested to do so by JBL Customer Support.

18 PERFORMING MEASUREMENTS

MULTI-POINT

One of the most advanced features of the SDP-75 is its unique multi-point measurement technology. Instead of using an averaged response out of multiple measurement points, the Trinnov Multi-point Algorithm is able to take every single measurement point into account.



The purpose of multi-point measurement is not only to optimize a wider listening area but also to get more information from measurements and increase reliability by taking into account important variations in the listening area.



NOTE: The multi-point approach ensures a more reliable calibration but choosing relevant microphone positions is highly critical.

18.1 RELEVANT MEASUREMENT POSITIONS

There are no fixed rules about choosing multi-point measurement positions. However, the microphone positions chosen has a profound impact on the quality of the results.



Figure 105: Relevant multi-point measurement positions

As an example, multi-point measurements can be performed for a single listening position:

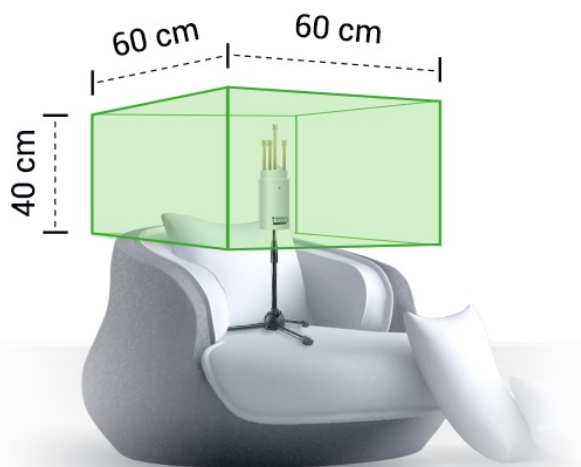

Figure 106: Relevant multi-point measurement area for a single listening position

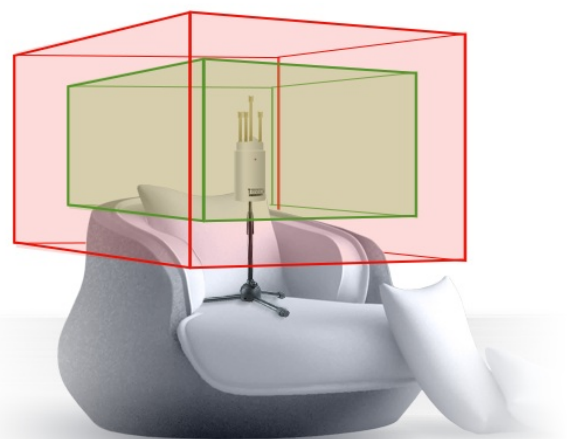

Figure 107: Relevant (green) / irrelevant (red) multi-point measurement area for a single listening position

18.2 MULTI-POINT CALIBRATION PROCEDURE

Multi-point measurements can be performed sequentially using the same microphone.

You can add a new measurement by pressing the **"Add"** button at the bottom of the page, or delete the selected measurement by pressing **"Delete"**. You can also rename a measurement by editing the text box "Measurement name".

For each measurement, the **"Calibrated"** column indicates "Yes" if the measurement has been correctly performed, "No" if it has not, and "Partial" if the calibration was interrupted before completion.

Each measurement contains the responses recorded during the calibration sound sequence.

Select the required measurement and press the **"Calibrate"** button to launch the calibration sequence.

Once every measurement has been calibrated, you can compute the acoustic correction filter that will best fit every point, accordingly to their weight.

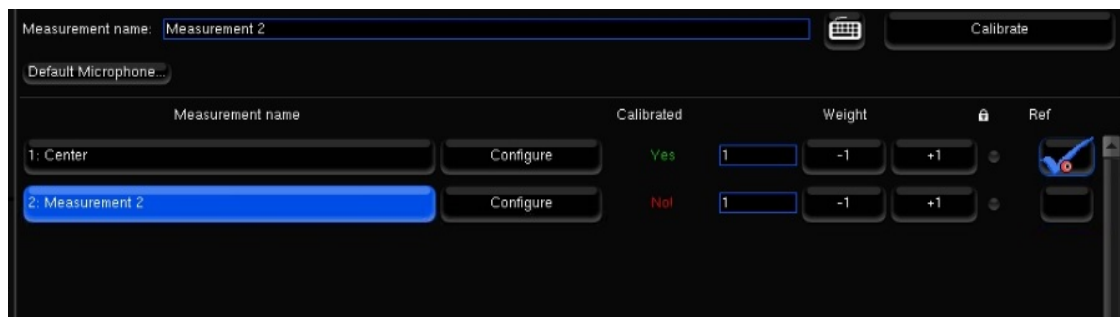

Figure 108: List of measurements

18.3 WEIGHTING MULTIPLE MEASUREMENTS

The **"Weight"** column allows you to set a weight to each measurement, from 0 to 100, to emphasize, for example, some central points. You can bypass some points by setting their weight to 0, which can be useful in case one of the points have failed the calibration but you don't want to perform a calibration again.

The weight can be adjusted after a calibration; you don't have to run a complete calibration to take weight changes into account, just to press once the **"Compute"** button.

You can adjust the weight of the measurements with your mouse clicking on +1 or -1, or with your keyboard, with the up (+1) and down (-1) arrows, or the page up (+10) and page down (-10) keys.

- All the measurements with non-null weight should be fully calibrated before computing the acoustic correction filters by pressing the **"Compute"** button. If some are partially or not calibrated at all, you will have to remove the bad points or their entire measurements, for example by setting their weight to 0, before being able to compute the acoustic filters.
- The **lock** disables measurement settings edition.
- The **"ref"** column indicates which measurement is the reference point. The reference point is unique, it can be modified after the calibration. Taking a new measurement into account as reference point requires to recompute the compensation filters.
- Before saving your preset in the "Presets" page, you have to save the multipoint parameters by pressing the **"Save changes"** button. These parameters are automatically saved (and the button disabled) when you leave the point list, and when you run a calibration or a computation.

19 APPENDIX

19.1 INSERT AN EXTERNAL STEREO DAC

As the SDP-75 has a flexible and complete range of output types, allowing the use of other DACs when desired.

The analog outputs 1-8 are duplicated on the AES outputs 1-8.

The analog outputs 1-2 are duplicated on the stereo analog SE outputs, AES outputs 1-2, as well as the SPDIF RCA and optical stereo outputs.

Make sure that the routing is correct.

It's up to you to choose the best way to feed you external DAC.

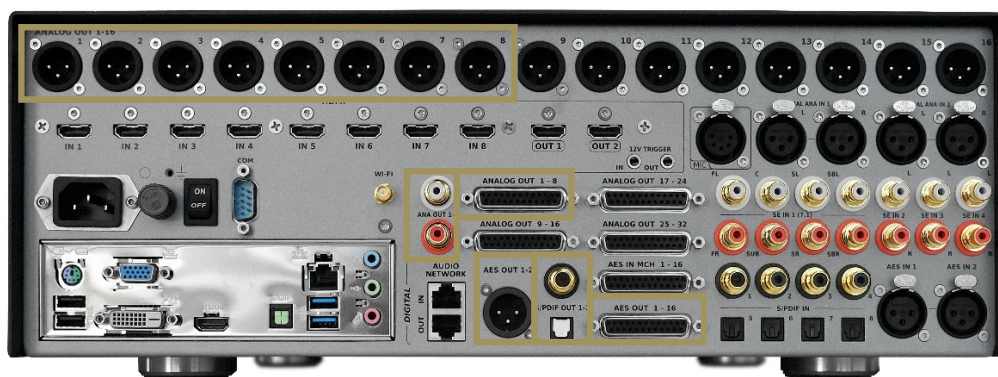

Figure 109: Duplicated Outputs

19.2 REMOTE START AND STOP

The SDP-75 can be remotely switched on via a **Wake-on-LAN** network message. Please ask a certified installer or an experienced IT technician for technical support.

It can also be switched off remotely over the network using the command provided within our **automation protocol** for that purpose, available for download on <http://www.jblsynthesis.com>.

The trigger input can also be used to switch the SDP-75 on and off from another device.

More information can be provided upon request.

19.3 AUTOMATION

The SDP-75 can be remotely controlled from an automation system through RS232 or Ethernet. As an example, it is possible to create a Crestron® module to remotely control the SDP-75 via RS232.

The specifications of the protocol are publicly available and can be downloaded from the **Products / Electronics / Surround Sound Preamplifiers / SDP-75 / Downloads / Software** section of the JBL Synthesis website: <http://www.jblsynthesis.com>

19.4 SIGNAL FLOW OF THE SDP-75



Not shown:

- Input & output routing / Physical inputs & outputs
- Manual input & output Eqs

19.4.1 SETUP PROCESS AND FILTERS CALCULATION

Active-Crossovers are set up first following a semi-automatic calibration procedure.

The Optimizer's filters calculation is made from the speaker measurement.

Bass management crossover filters are applied after and regardless of the loudspeaker calibration. The crossover frequencies and bass management mode can therefore be modified after calibration.

19.5 3D SPEAKER PLACEMENT RECOMMENDATIONS

For detailed information about speaker placement recommendations, please refer to the following documents:

- Auro-3D Home Theatre Setup Installation Guidelines, available from Auro Technologies.
- http://www.auro-3d.com/wp-content/uploads/documents/Auro-3D-Home-Theater-Setup-Guidelines_lores.pdf
- Dolby Atmos Home Theatre Installation Guidelines, available from Dolby:
- <http://www.dolby.com/us/en/technologies/dolby-atmos/dolby-atmos-home-theater-installation-guidelines.pdf>



NOTE: As of July 2016, the DTS X Home Theatre Installation Guidelines are not yet available.

19.6 DB25 CONNECTOR: ANALOG PINOUT

The SDP-75 uses DB25 connectors for Analog output connections. We use the widely-used **Tascam** DB25 scheme described below.

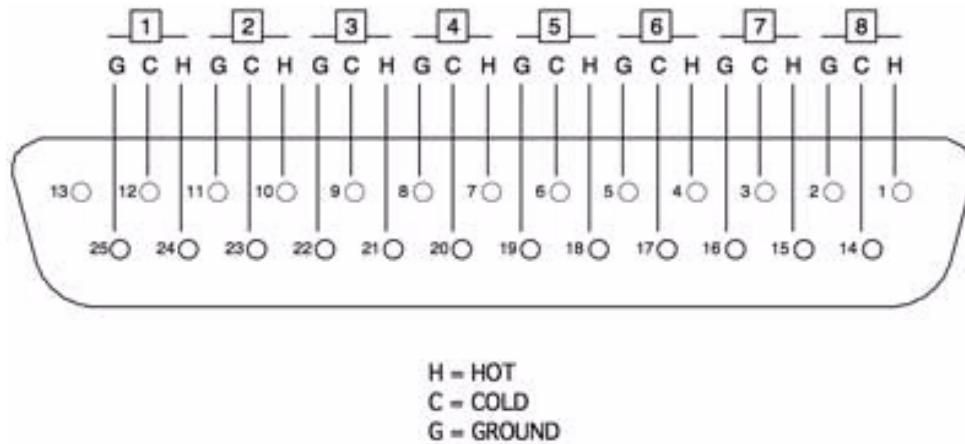

Figure 110: Tascam pinout for the AES DB25 output connector



NOTE: Another quite popular pinout is the one from Yamaha. You should check which pinout your equipment is using before connecting it to the SDP-75. Unbalanced connections must connect signal to SubD-Hot and shield to SubD-Cold.

19.7 DB25 CONNECTOR : AES PINOUT

The SDP-75 uses DB25 connectors for AES connections, input as well as output. We use the widely-used **Tascam** DB25 scheme described below.

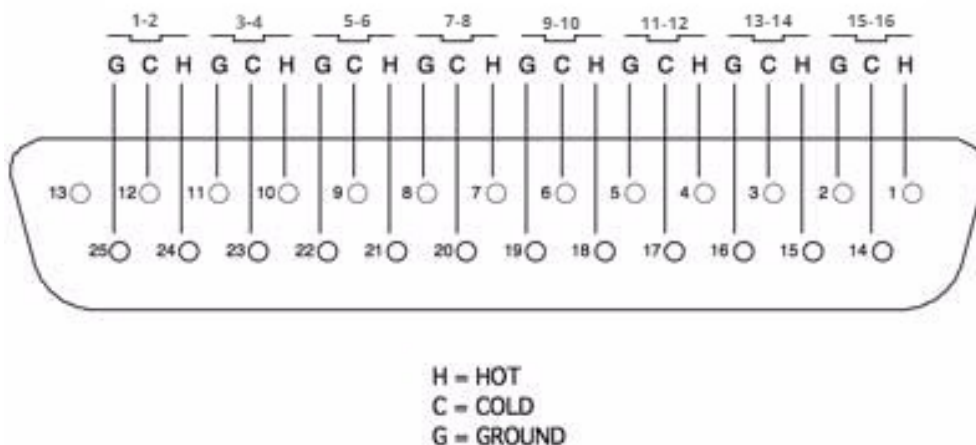

Figure 111: Tascam pinout for the AES DB25 output connector



NOTE: Another quite popular pinout is the one from Yamaha. You should check which pinout your equipment is using before connecting it to the SDP-75. Unbalanced connections must connect signal to SubD-Hot and shield to SubD-Cold.

19.8 3D MEASUREMENT MICROPHONE

The purpose of the calibration microphone is to measure the characteristics of the loudspeaker and their layout in the room.

For each loudspeaker, the Optimizer gathers the following information:

- full 3D position
- amplitude response
- phase response



19.8.1 MICROPHONE SPECIFICATIONS

- 4 capsules in tetrahedron configuration.
- Individual compensation filters
- Frequency response within +/- 0.1dB across the 20Hz-24kHz frequency range
- Spatial resolution below +/-2°
- Built-in preamp
- A 9V PP3 LR61 battery powers capsules and electronics
- Camera / Microphone thread.

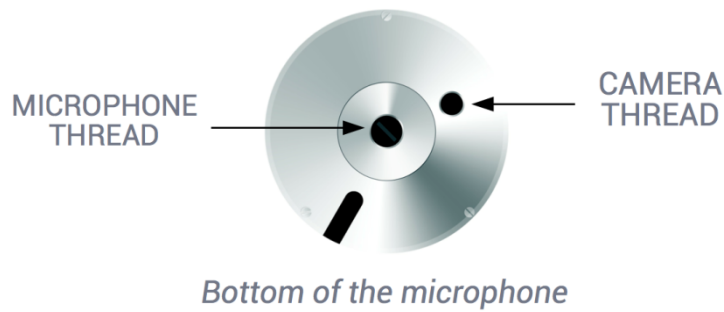

19.8.2 POWER SUPPLY

The power supply located in the base of the microphone uses a standard 9V PP3 LR61 battery. The red led indicates the battery Level. Replacing the battery requires removing the 3 screws at the bottom of the microphone.

19.8.3 INDIVIDUAL COMPENSATION FILE

The individual compensation file of the microphone used by the SDP-75 can be modified in the **Optimizer Settings/Calibration** page.



Calibration page

Always make sure the microphone serial number indicated in the **Configure** page matches the label at the bottom of your microphone. If not, use the **Configure** button of the required Measurement to select the correct compensation file.

For future measurements, use the **Default Microphone** button to make the required compensation file automatically selected in the preset.

The 3D localization of the speakers can only be performed if the connection order of the capsules is respected.

19.8.4 CONNECTION ORDER

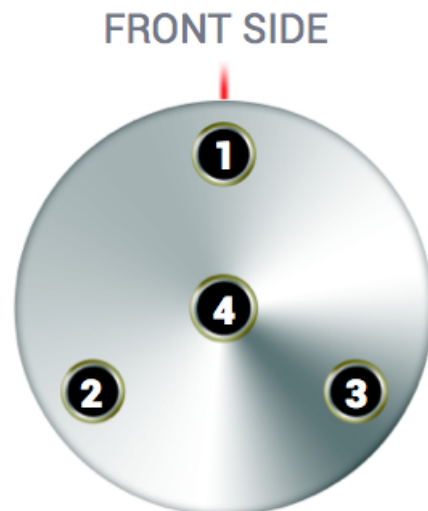
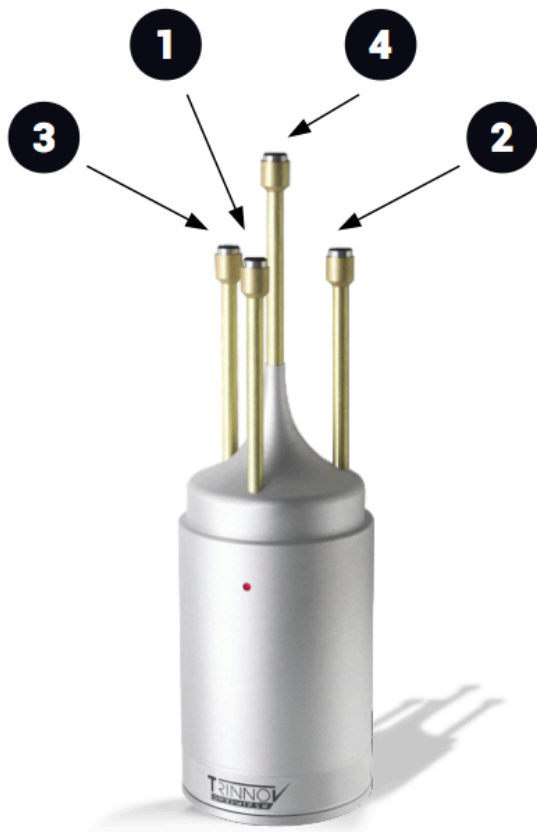
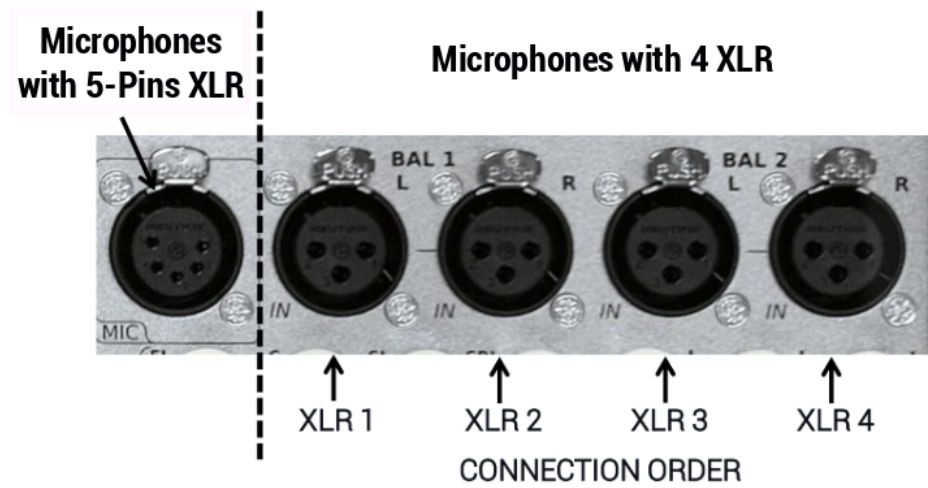

Thank you for your attention
Please enjoy your Sound.

