

# Quick Installation Guide

**CoolMaster Product Line:**

CoolMaster, CoolMasterPro, CoolMasterNet

**HVAC Bridge**



**COOLAUTOMATION**

THE INTERNET OF CLIMATE

# Warning

Read these **Safety Precautions** carefully to ensure correct installation.

This manual classifies precautions into **WARNING** and **CAUTION**.



**Failure to follow WARNING is very likely to result in such grave consequences as death or serious injury**

## **WARNING**

- Only qualified personnel must carry out the installation work.
- Ask your dealer or technical representative to install the unit.
- Any deficiency caused by your own installation may result in an electric shock or fire.
- All electrical work must be performed by a licensed technician, according to local regulations and in accordance with the instructions in the installation manual.
- Any lack of electric circuit or any deficiency caused by installation may result in an electric shock or fire.
- Do not relocate or reinstall the **CoolMaster device** by yourself.
- Any deficiency caused by your own re-installation may result in an electric shock or fire.
- Make sure that all wiring is secured, that specified wires are used and that no external forces act on terminal connections or wires. Improper wiring connections or installation may produce heat and result in fire.
- Before touching electrical parts, turn off the unit.
- To dispose of this product, consult your dealer.

# Caution



Failure to follow CAUTION may result in serious injury or property damage, and in certain circumstances, may result in a grave onsequence.

## CAUTION

- Do not allow children to play with the **CoolMaster device** and supervise them not to get access to the appliance.
- **CoolMaster device** is not to be used by persons with reduced physical, sensory or mental capabilities, or lack of experience and knowledge.
- Do not disassemble, modify or repair the **CoolMaster device**.
- Any deficiency caused by your modification or repair may result in an electric shock or fire.
- Never let the **CoolMaster device** to get wet.
- Water can cause damage to the **CoolMaster device**, and may cause an electric shock or fire.
- Do not use flammable materials (e.g. hairspray or insecticide) near the **CoolMaster device**.
- Do not clean the **CoolMaster device** with organic solvents such as paint thinner. The use of organic solvents may cause cracking, damaging the **CoolMaster device**, causing electrical shock or fire.
- **Do not apply AC110V or AC220V to the CoolMaster device. The maximum voltage that can be applied to the unit directly is 24V DC.**
- If damaged **CoolMaster device** can generate heat and cause a fire.

# Caution



Failure to follow CAUTION may result in serious injury or property damage, and in certain circumstances, may result in a grave consequence.

## DO NOT INSTALL THE COOLMASTER DEVICE IN THE FOLLOWING LOCATIONS:

- a) Where a mineral oil mist or oil spray or vapor is produced, for example, in a kitchen. Plastic parts may deteriorate and fall off or result in water leakage.
- b) Where corrosive gas, such as sulfurous acid gas, is produced.
- c) Near machinery emitting electromagnetic waves. Electromagnetic waves may disturb the operation of the **CoolMaster device** and cause the unit to malfunction.
- d) Where flammable gas may leak, where there is carbon fiber or ignitable dust suspensions in the air, or where volatile flammable such as thinner or gasoline are handle Operating the **CoolMaster device** in such conditions can cause a fire.
- e) High temperature area or directly flamed point. Heating and/or fire can occur.
- f) Moist area, where there is exposure to water. If water enters the inside of the **CoolMaster device**, it may cause electric shock and electrical components may fail.

# Contents

|                                       |    |
|---------------------------------------|----|
| Warning .....                         | 2  |
| Caution.....                          | 3  |
| Contents .....                        | 5  |
| What's in the box .....               | 6  |
| CoolMaster Device.....                | 7  |
| Preconfigured CoolMaster Device ..... | 8  |
| HVAC Line configuration .....         | 9  |
| CoolMaster Prodcut line .....         | 10 |

|   |    |
|---|----|
| <b>L1</b> HVAC Daikin VRV (Yanmar).....     | 11 |
| HVAC Daikin Non-VRV .....                   | 12 |
| HVAC Mitsubishi Electric VRF (Trane) .....  | 13 |
| HVAC Mitsubishi Electric Non-VRF .....      | 14 |
| HVAC Panasonic/Sanyo VRF.....               | 15 |
| HVAC Toshiba VRF (Carrier) .....            | 16 |
| HVAC Hitachi VRF (Hisense, York, JCI) ..... | 17 |
| HVAC Haier VRF (York, Trane, CIAC) .....    | 18 |

|  |    |
|--|----|
| <b>L7</b> HVAC Mitsubishi Heavy VRF..... | 19 |
| HVAC LG VRF (Arcelik) .....              | 20 |
| HVAC AUX VRF (Rheem, IGC).....           | 21 |

|  |    |
|--|----|
| <b>L7</b> HVAC Gree/GMV4 VRF (Lennox, Tica, Innovair).....   | 22 |
| HVAC Midea VRF (Intensity, Trane, Carrier, Lennox, Comfort Star, Kentatsu, Electra ,Voltas, Bryant, Maxxa, Ecox, Clivet, Bosch ,SystemAir, Lessar, NED, Dantex, Sanys) ..... | 23 |
| HVAC Samsung VRF (Trane) .....   | 24 |
| HVAC Chigo VRF (Rheem, Sharp) .....  | 25 |
| HVAC Blue Star VRF.....  | 26 |
| HVAC TICA VRF .....  | 27 |

|  |    |
|--|----|
| <b>L8</b> HVAC Gree GMV5, GMV6 (Gree) VRF (Fujitherma, Aermec, Tosot, Tadiran, Energolux, AlpicAir, Cooper&Hunter, Pioneer, Lennox, Air Con) ..... | 28 |
| HVAC Fujitsu VRF (Rheem, Atlantic) .....   | 29 |

|  |    |
|--|----|
| How to change the brand of a specific line ..... | 30 |
| CoolMaster Device installation complete .....    | 31 |
| Home Automation, BMS & iocControl App.....       | 32 |
| Power Supply.....                                | 33 |
| All On/Off operation by external signal .....    | 34 |
| Mounting on DIN rail.....                        | 35 |
| Mounting on a wall .....                         | 36 |
| Online documentation and Support .....           | 37 |

# What's in the box

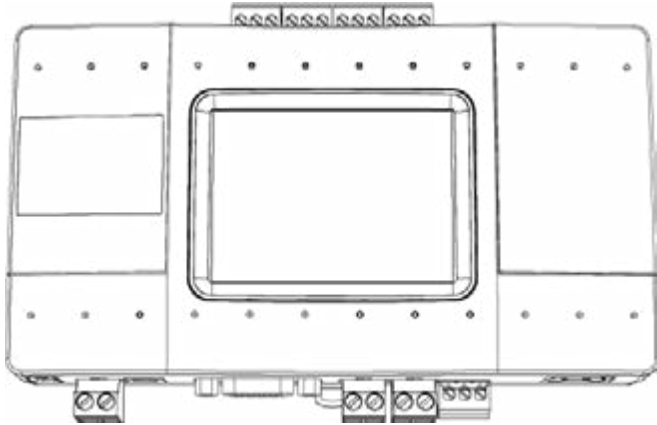

CoolMaster device

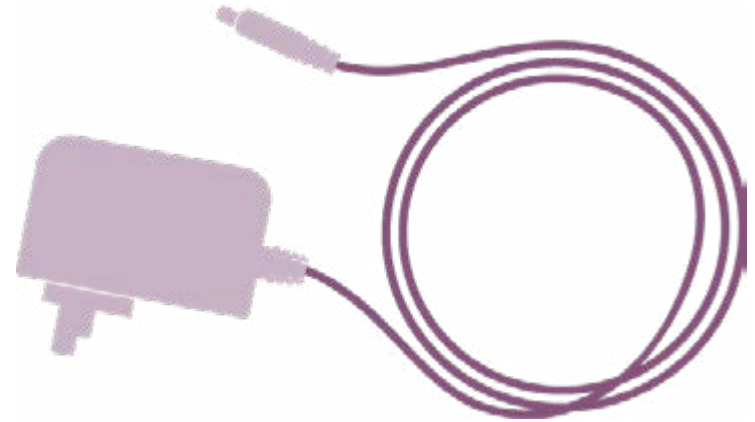

AC Power supply adapter  
100V-240V 50/60hz to 12V

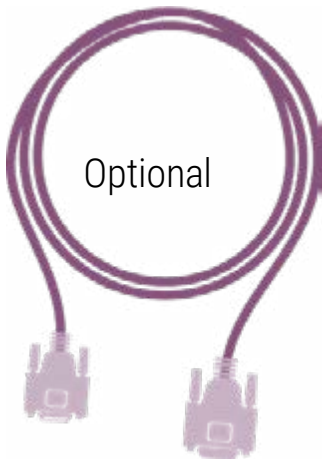

Optional  
1 RS232 DB9  
Male to Female  
cable

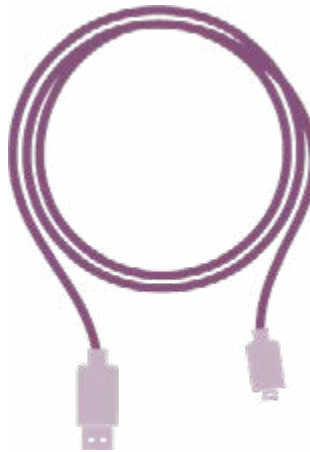

1 USB-Mini USB  
cable



1 Ethernet  
cable

# CoolMaster device

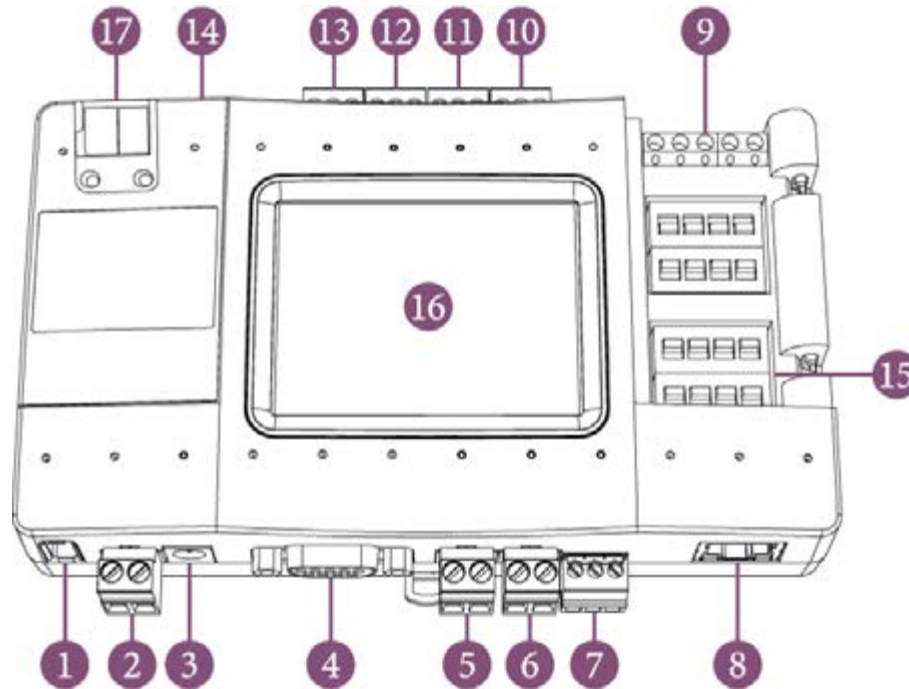

1 L8 - HVAC Line 8 (USB Host)

2 Power

3 Power Plug

4 RS232 Port

5 L1 - HVAC Line 1

6 L2 - HVAC Line 2

7 L3 - RS485

8 Ethernet Port

9 GPIOs

10 L7 - HVAC Line 7

11 L6 - HVAC Line 6

12 L5 - HVAC Line 5

13 L4 - HVAC Line 4

14 USB Device Port

15 DIP Switches P, Q, R, S

16 LCD Touch Screen

17 KNX (option)

# Preconfigured CoolMaster Device

## Type label

This label uniquely identifies the manufacturer's configuration of the CoolMaster device. Located on the back of the enclosure.

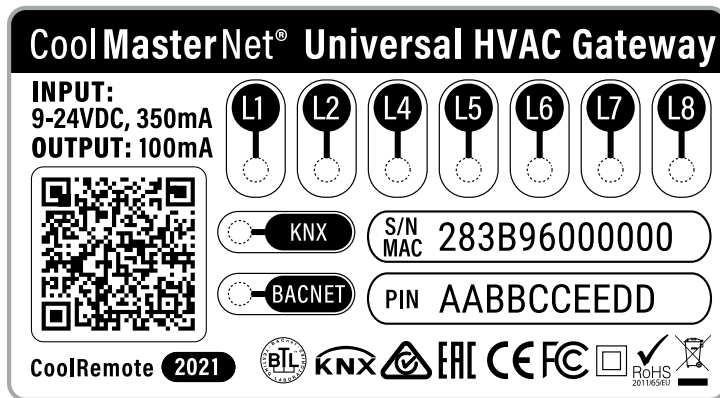

## Type label with Configuration sticker

A preconfigured label example:  
configured for LG on L7

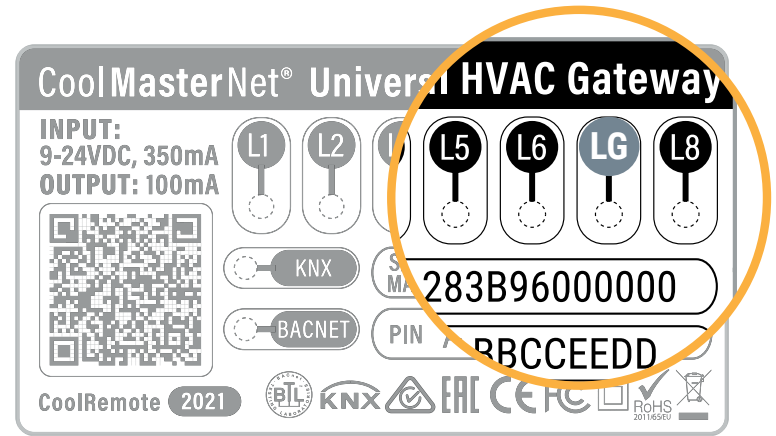



# HVAC Line configuration

DK Daikin

HT Hitachi

HA Haier

ME Mitsubishi Electric

TO Toshiba

PN Panasonic

FJ Fujitsu

LG LG

SM Samsung

MD Midea

CG Chigo

GR Gree

AU AUX

BS Blue Star

MH Mitsubishi Heavy

# CoolMaster Product line



|                                     | COOLMASTER   | COOLMASTERPRO               |
|-------------------------------------|--|-----------------------------|
| <b>Market Segment</b>               | Residential  | Medium and Large Commercial |
| <b>Main Use</b>                     | Home Automation Integration,<br>Remote control App | BMS integration             |
| <b>Max Connected Units</b>          | 32   | 256*                        |
| <b>Local access to service data</b> | X  | ✓                           |

\* Max Connected Units is different per VRF/VRV manufacturer and include any type of connected unit (VRF indoor, CP, sensor, fan coil, any other HVAC unit). Please refer to technical specifications for more details.

# HVAC Daikin VRV

## 1 HVAC Communication Terminals

HVAC outdoor connection

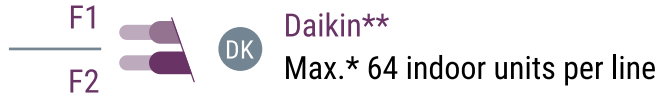

- \* For Heat Recovery systems the connection is at outdoor units only.
- \* See table on page 10 for Max connected indoors per model.
- \* Polarity is not required on the HVAC communication line.
- \*\* Centralized (group) address required.

## 2 Connecting to the line plug

Secure the cables in the L1 line plug.

## 3 Plugging to the CoolMaster device

Insert the plug in to the CoolMaster device L1 socket.

## 4 Check DIP Switches are set correctly

Dip switches setup for VRV HVAC system on L1.

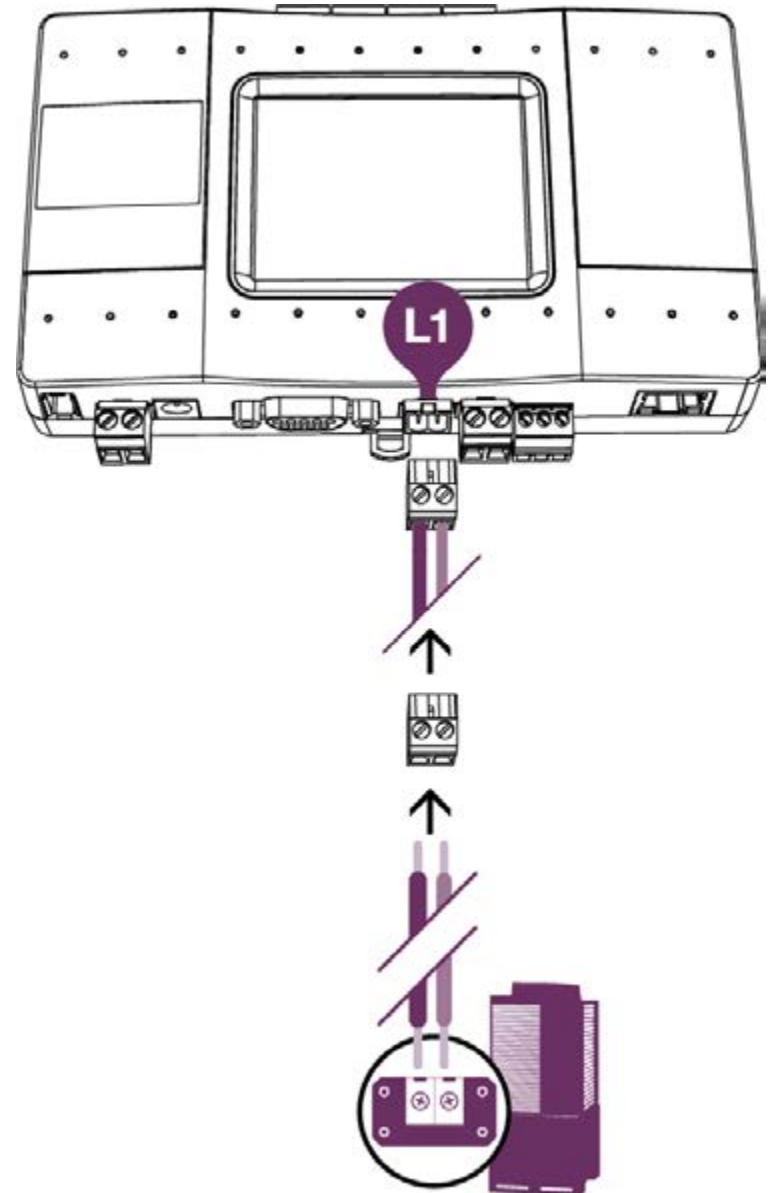
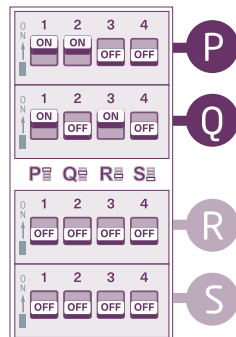

Daikin HVAC Terminal

# HVAC Daikin Non-VRV



**Changing the dip switches **S**, while DC voltage is present on L1, may damage the CoolMaster device.**

For Daikin Non-VRV equipment, DC voltage supply by CoolMaster device might be required for proper operation.

**! Make sure CoolMaster device is disconnected from power and HVAC line.**

## 1 HVAC Communication Terminals

HVAC Indoor connection

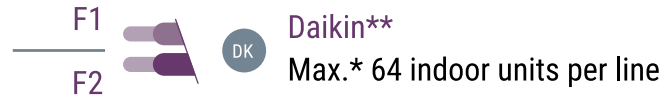

\* See table on page 10 for Max connected indoors per model.

\* Polarity is not required on the HVAC communication line.

\*\* Centralized (group) address required.

- 2 Measure DC voltage on HVAC comm. line L1
- 3 If no **14-16V DC voltage** change the dip switches as shown below:  
Go to settings → Go to HVAC lines → Go to L1 → Go to DC Out turn on
- 4 Turn **ON** the power for CoolMaster device and **connect** it to HVAC line.
- 5 Connect to the communication terminals on the HVAC equipment and secure the cables in the L1 line plug.
- 6 Insert the plug in to CoolMaster device L1 socket.

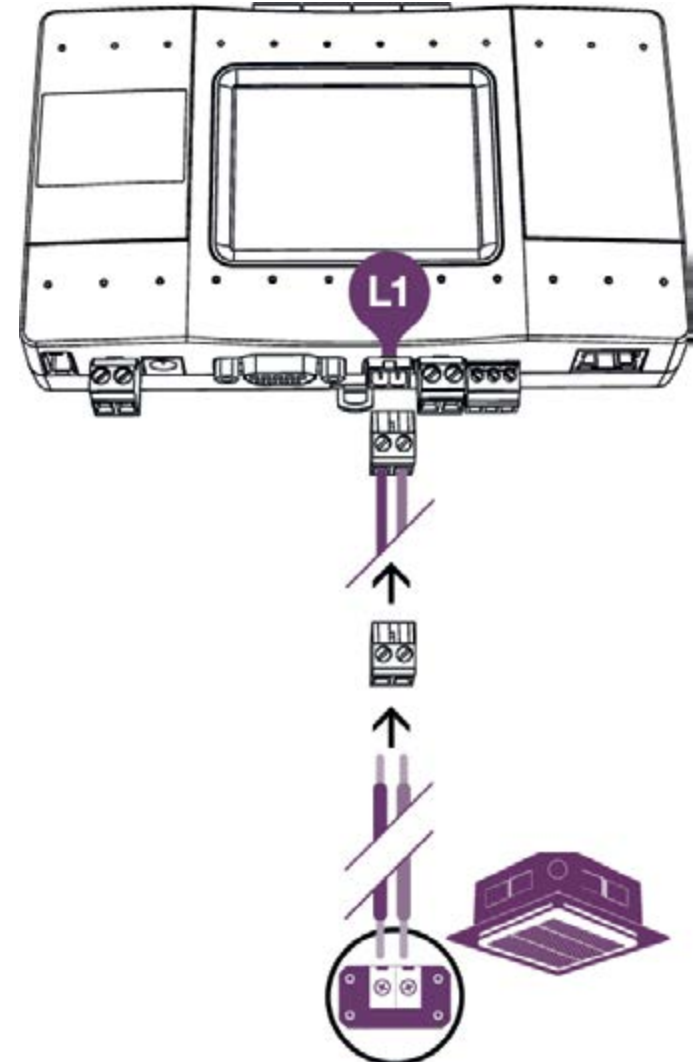
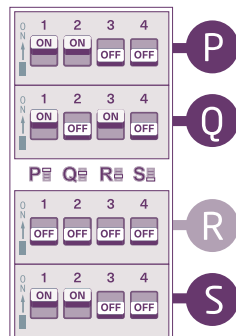
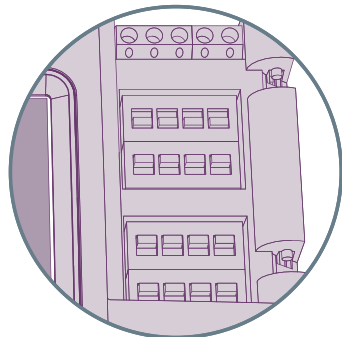

Daikin Non-VRV HVAC Terminal

# HVAC Mitsubishi Electric VRF

## ① HVAC Communication Terminals

HVAC outdoor connection

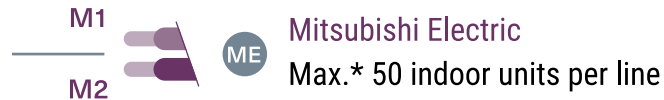

- \* See table on page 10 for Max connected indoors per model.
- \* For Heat Recovery systems the connection is at outdoor units only.
- \* Polarity is not required on the HVAC communication line.

## ② Connecting to the line plug

Secure the cables in the L1 line plug.

## ③ Plugging to the CoolMaster device

Insert the plug in to the CoolMaster device L1 socket.

## ④ Check DIP Switches are set correctly

Dip switches setup for VRF HVAC system on L1.

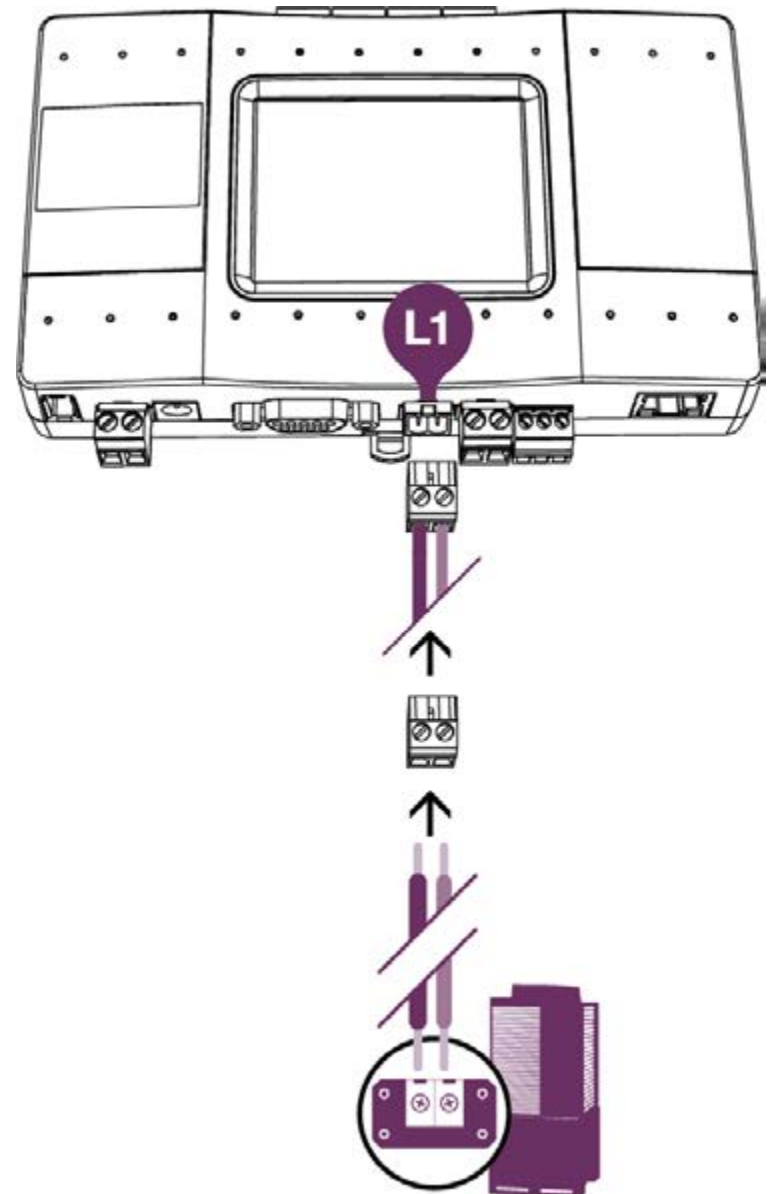
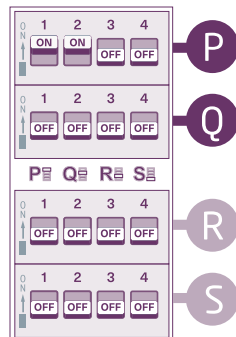

Mitsubishi Electric HVAC Terminal

# HVAC Mitsubishi Electric Non-VRF



**Changing the dip switches **S**, while DC voltage is present on L1, may damage the CoolMaster device.**

For Mitsubishi Electric Non-VRF equipment, DC voltage supply by CoolMaster device might be required for proper operation.

**! Make sure CoolMaster device is disconnected from power and HVAC line.**

## 1 HVAC Communication Terminals

HVAC Indoor connection

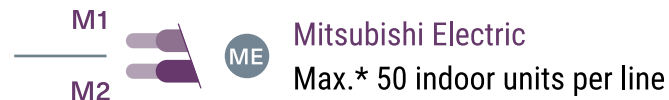

\* See table on page 10 for Max connected indoors per model.

\* Polarity is not required on the HVAC communication line.

- 2 Measure DC voltage on HVAC comm. line L1
- 3 If no **28-30V DC voltage** change the dip switches as shown below:  
Go to settings → Go to HVAC lines → Go to L1 → Go to DC Out turn on
- 4 Turn ON the power for CoolMaster device and connect it to HVAC line.
- 5 Connect to the communication terminals on the HVAC equipment and secure the cables in the L1 line plug.
- 6 Insert the plug in to CoolMaster device L1 socket.

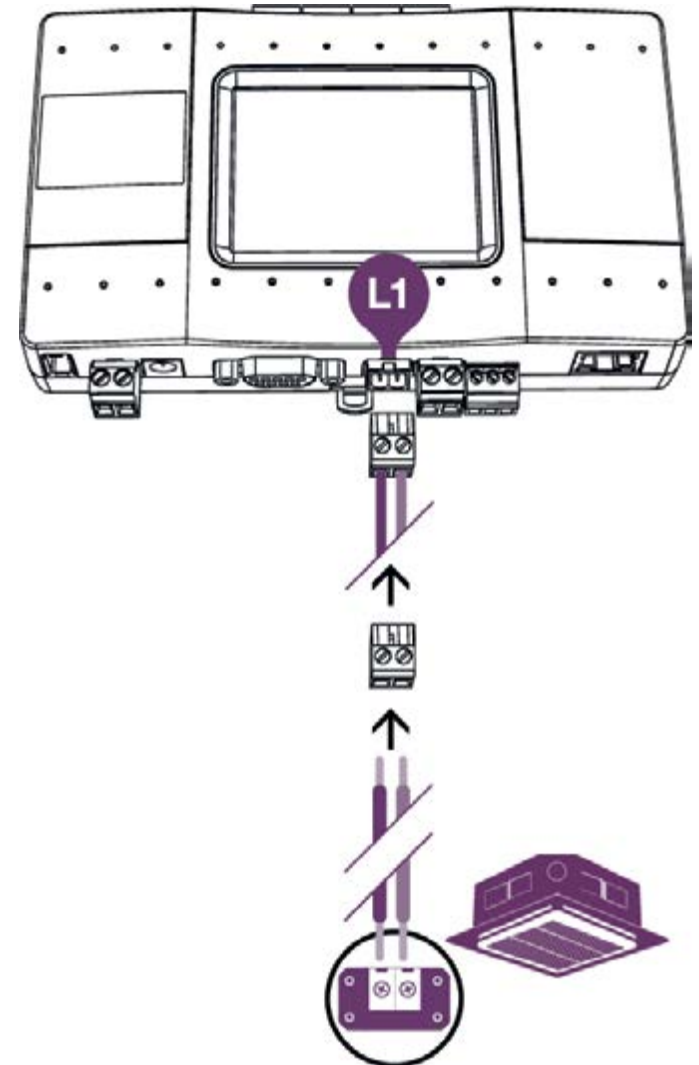
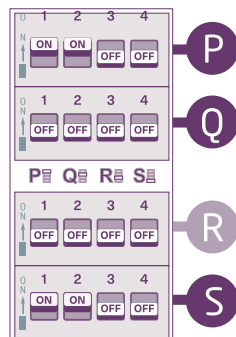
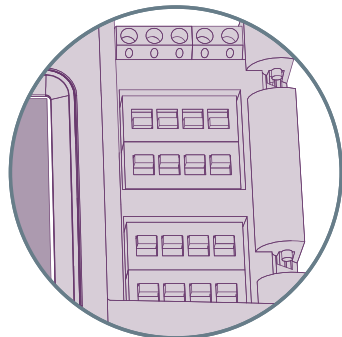

Mitsubishi Non-VRF HVAC Terminal

# HVAC Panasonic/Sanyo VRF

## ① HVAC Communication Terminals

HVAC outdoor connection

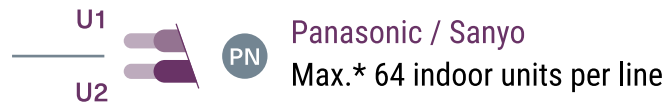

- \* See table on page 10 for Max connected indoors per model.
- \* For Heat Recovery systems the connection is at outdoor units only.
- \* Polarity is not required on the HVAC communication line.

## ② Connecting to the line plug

Secure the cables in the L1 line plug.

## ③ Plugging to the CoolMaster device

Insert the plug in to the CoolMaster device L1 socket.

## ④ Check DIP Switches are set correctly

Dip switches setup for VRF HVAC system on L1.

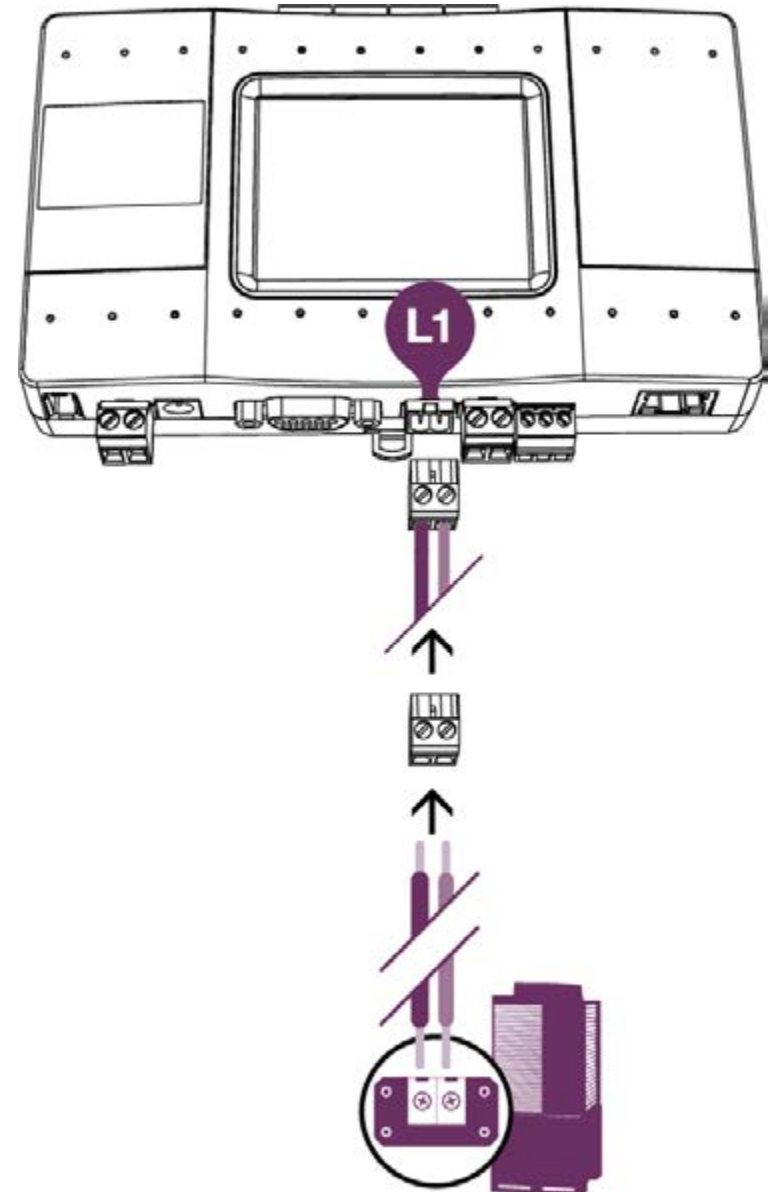
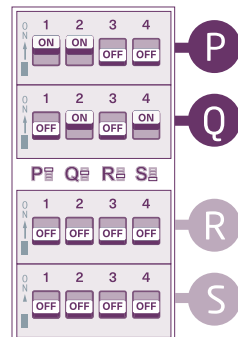

Panasonic / Sanyo HVAC Terminal

# HVAC Toshiba VRF

## 1 HVAC Communication Terminals

HVAC outdoor connection

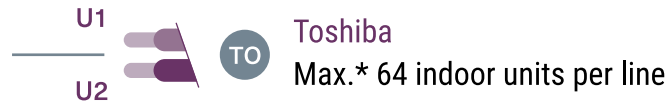

- \* See table on page 10 for Max connected indoors per model.
- \* For Heat Recovery systems the connection is at outdoor units only.
- \* Polarity is not required on the HVAC communication line.

## 2 Connecting to the line plug

Secure the cables in the L1 line plug.

## 3 Plugging to the CoolMaster device

Insert the plug in to the CoolMaster device L1 socket.

## 4 Check DIP Switches are set correctly

Dip switches setup for VRF HVAC system on L1.

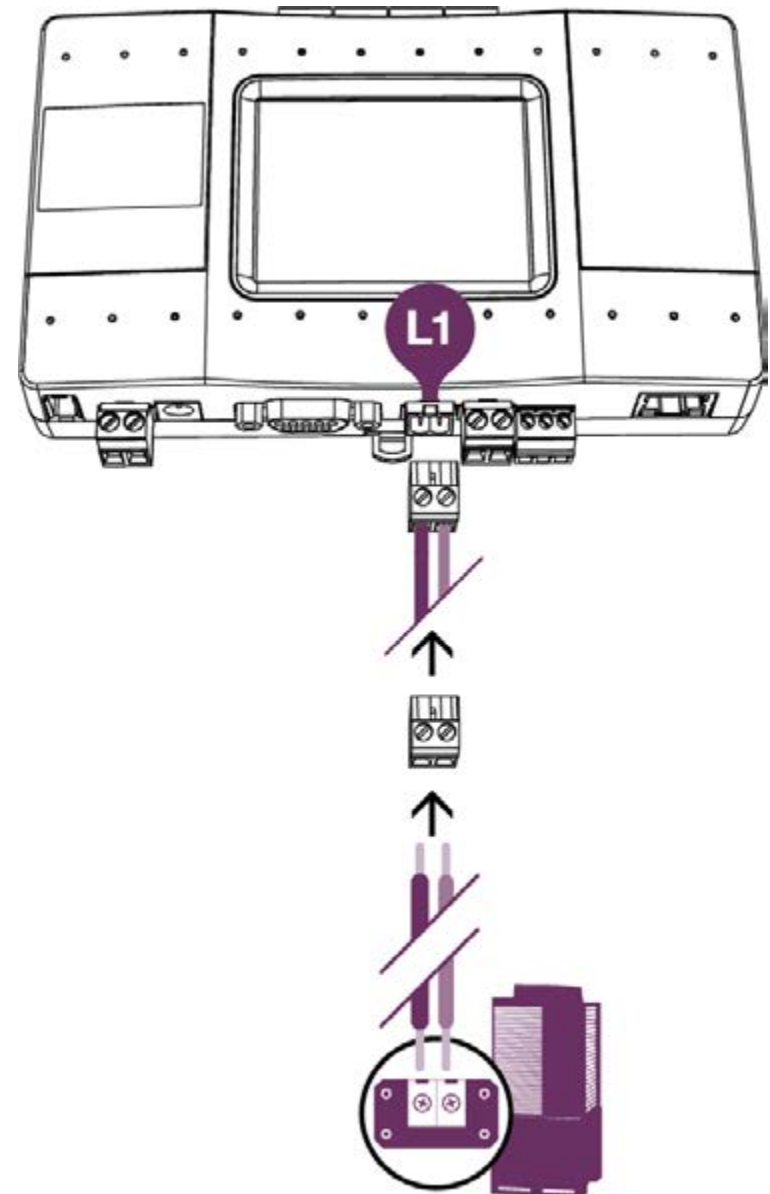
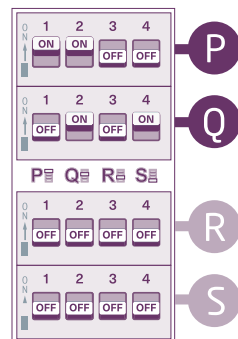

Toshiba HVAC Terminal



# HVAC Hitachi VRF

## ① HVAC Communication Terminals

HVAC outdoor connection



- \* See table on page 10 for Max connected indoors per model.
- \* For Heat Recovery systems the connection is at outdoor units only.
- \* Polarity is not required on the HVAC communication line.

## ② Connecting to the line plug

Secure the cables in the L1 line plug.

## ③ Plugging to the CoolMaster device

Insert the plug in to the CoolMaster device L1 socket.

## ④ Check DIP Switches are set correctly

Dip switches setup for VRF HVAC system on L1.

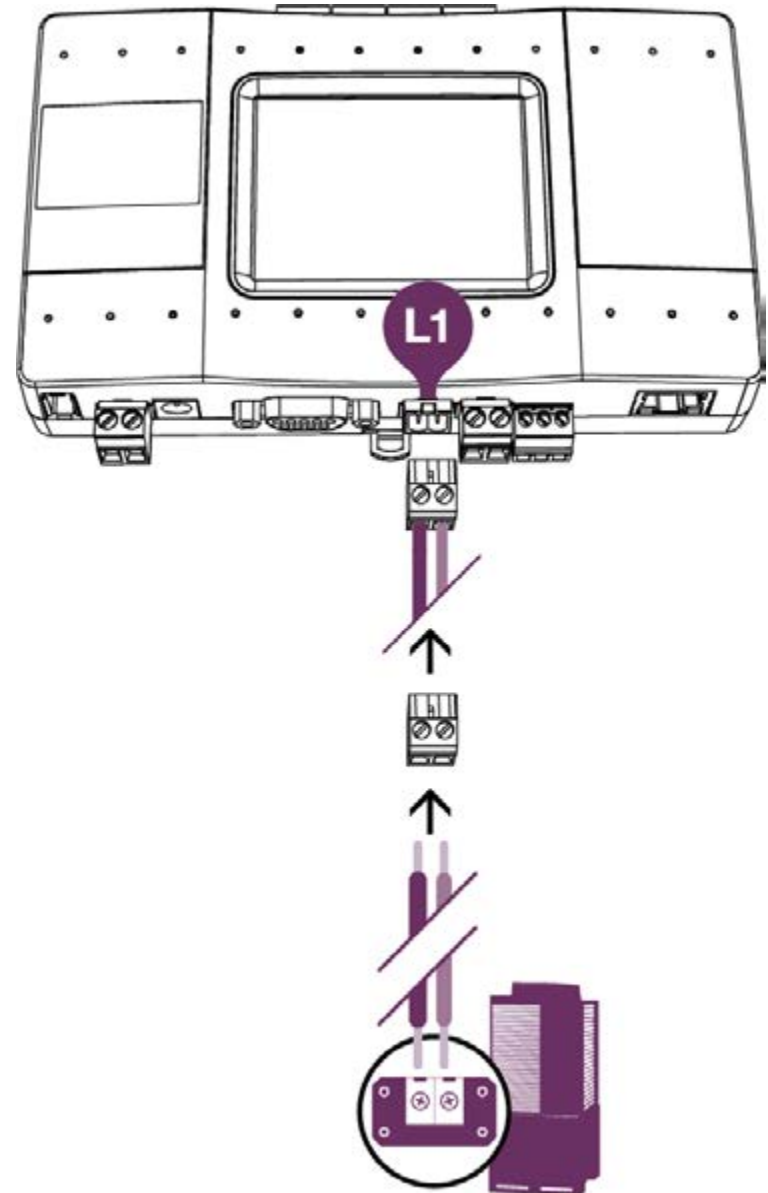
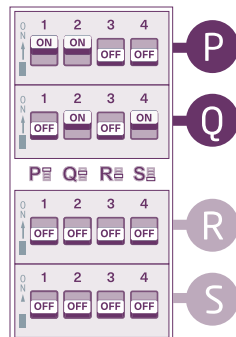

Hitachi HVAC Terminal

# HVAC Haier VRF

## ① HVAC Communication Terminals

HVAC outdoor connection

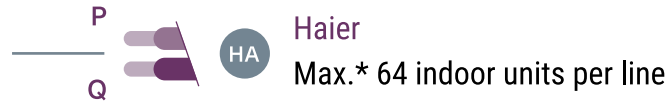

- \* See table on page 10 for Max connected indoors per model.
- \* For Heat Recovery systems the connection is at outdoor units only.
- \* Polarity is not required on the HVAC communication line.

## ② Connecting to the line plug

Secure the cables in the L1 line plug.

## ③ Plugging to the CoolMaster device

Insert the plug in to the CoolMaster device L1 socket.

## ④ Check DIP Switches are set correctly

Dip switches setup for VRF HVAC system on L1.

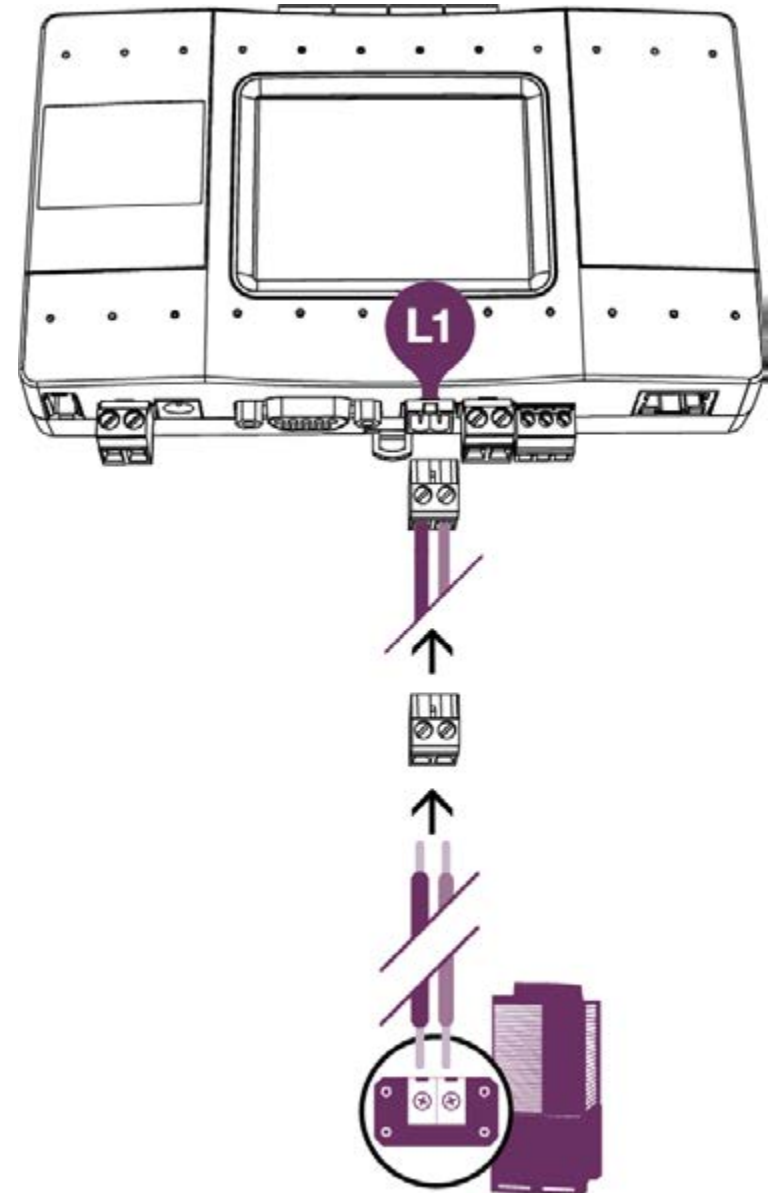
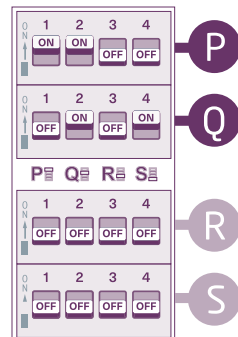

Haier HVAC Terminal

# HVAC Mitsubishi Heavy VRF

## ① HVAC Communication Terminals

HVAC outdoor connection

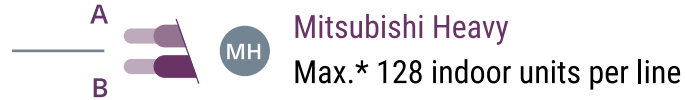

\* See table on page 10 for Max connected indoors per model.

## ② Connecting to the line plug

Secure the cables in the L7 line plug.

## ③ Plugging to the CoolMaster device

Insert the plug in to the CoolMaster device L7 socket.

## ④ Check DIP Switches are set correctly

Dip switches setup for VRF HVAC system on L7.

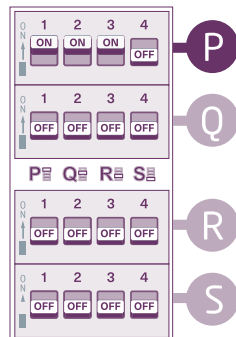

Mitsubishi Heavy HVAC Terminal

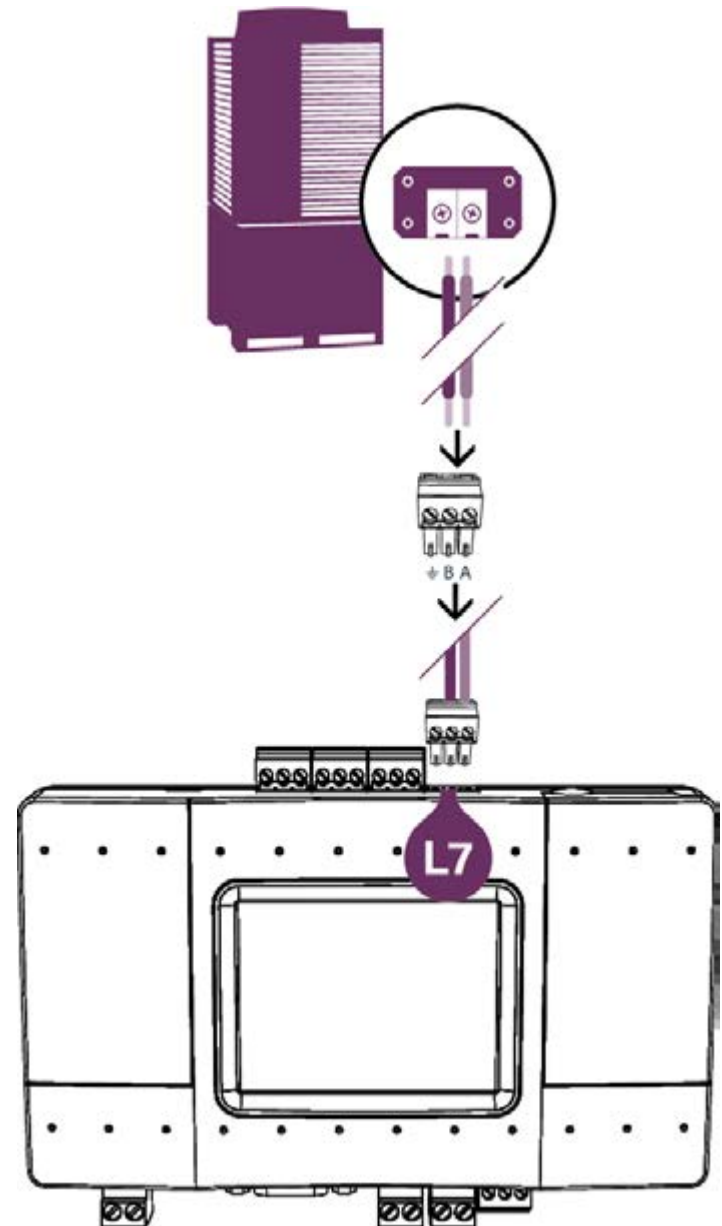

# HVAC LG VRF

## ① HVAC Communication Terminals

HVAC outdoor connection

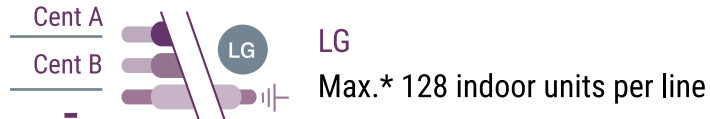

\* See table on page 10 for Max connected indoors per model.

## ② Connecting to the line plug

Secure the cables in the L7 line plug.

## ③ Plugging to the CoolMaster device

Insert the plug in to the CoolMaster device L7 socket.

## ④ Check DIP Switches are set correctly

Dip switches setup for VRF HVAC system on L7.

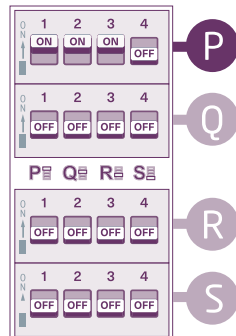

LG HVAC Terminal

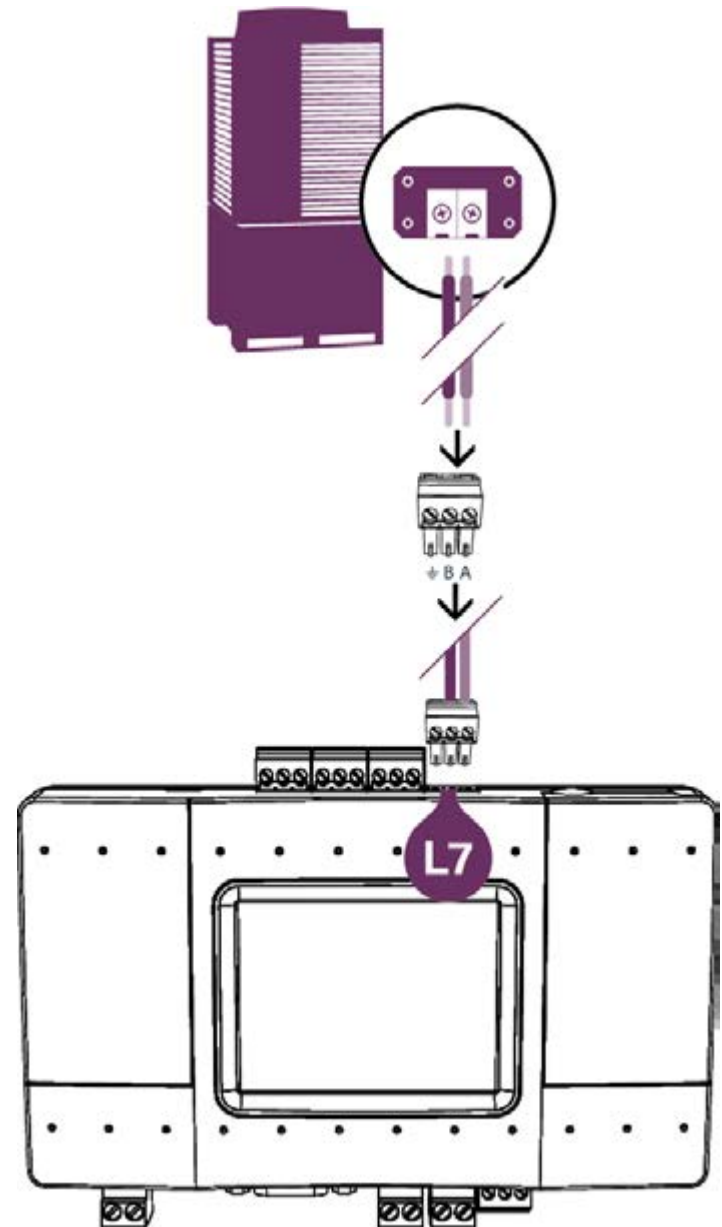

# HVAC AUX VRF

## ① HVAC Communication Terminals

HVAC outdoor connection



\* See table on page 10 for Max connected indoors per model.

## ② Connecting to the line plug

Secure the cables in the L7 line plug.

## ③ Plugging to the CoolMaster device

Insert the plug in to the CoolMaster device L7 socket.

## ④ Check DIP Switches are set correctly

Dip switches setup for VRF HVAC system on L7.

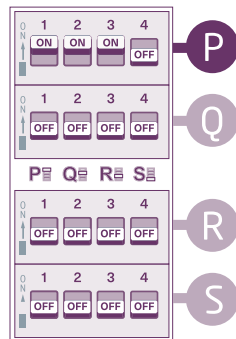

AUX HVAC Terminal

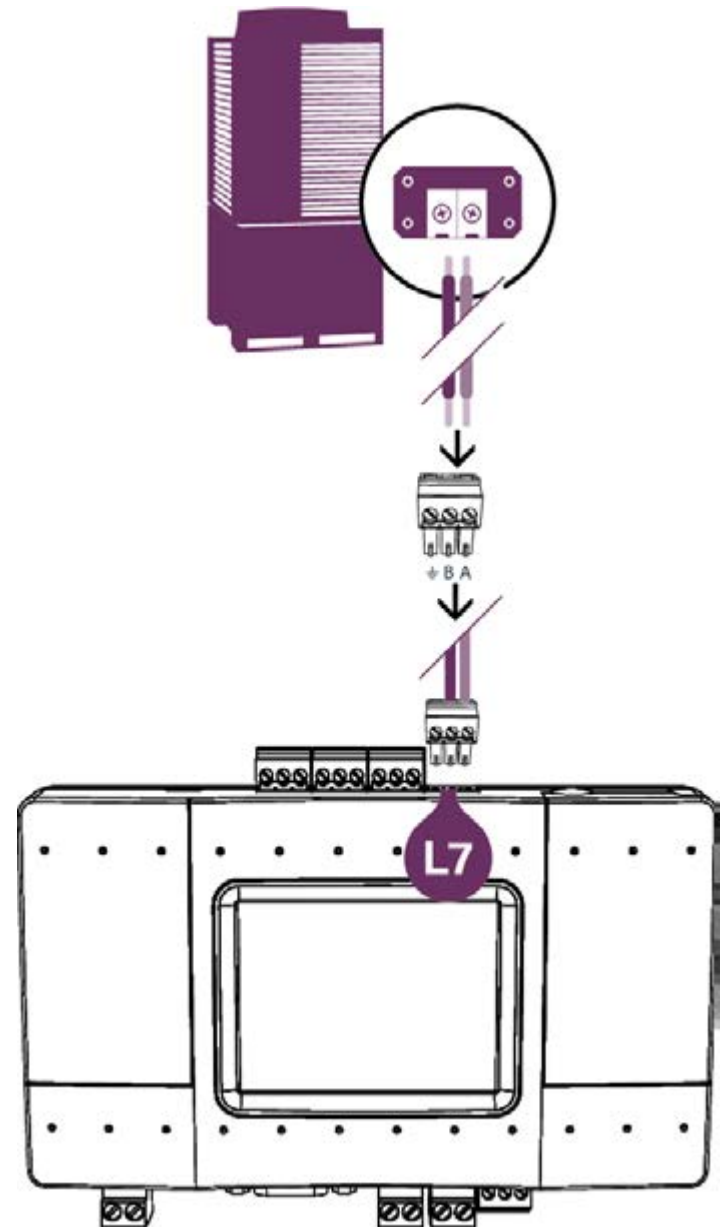

# HVAC Gree/GMV4 VRF

## ① HVAC Communication Terminals

HVAC outdoor connection

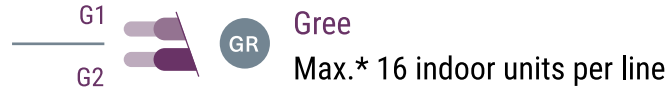

\* See table on page 10 for Max connected indoors per model.

## ② Connecting to the line plug

Secure the cables in the L7 line plug.

## ③ Plugging to the CoolMaster device

Insert the plug in to the CoolMaster device L7 socket.

## ④ Check DIP Switches are set correctly

Dip switches setup for VRF HVAC system on L7.

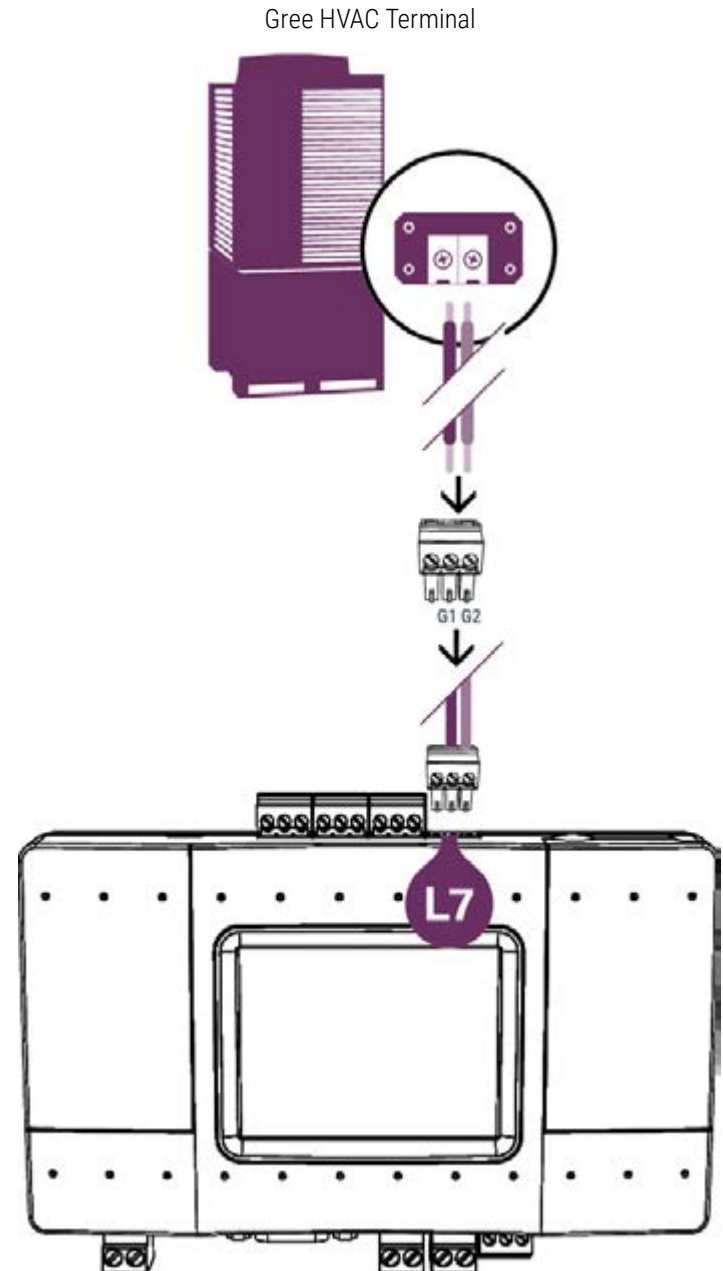
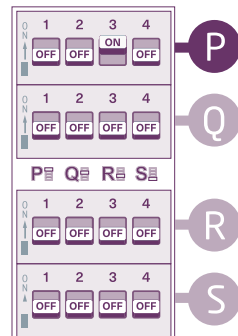

# HVAC Midea VRF

## ① HVAC Communication Terminals

HVAC outdoor connection



\* See table on page 10 for Max connected indoors per model.

## ② Connecting to the line plug

Secure the cables in the L7 line plug.

## ③ Plugging to the CoolMaster device

Insert the plug in to the CoolMaster device L7 socket.

## ④ Check DIP Switches are set correctly

Dip switches setup for VRF HVAC system on L7.

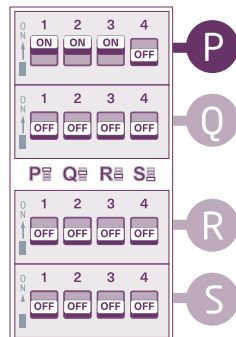

Midea HVAC Terminal

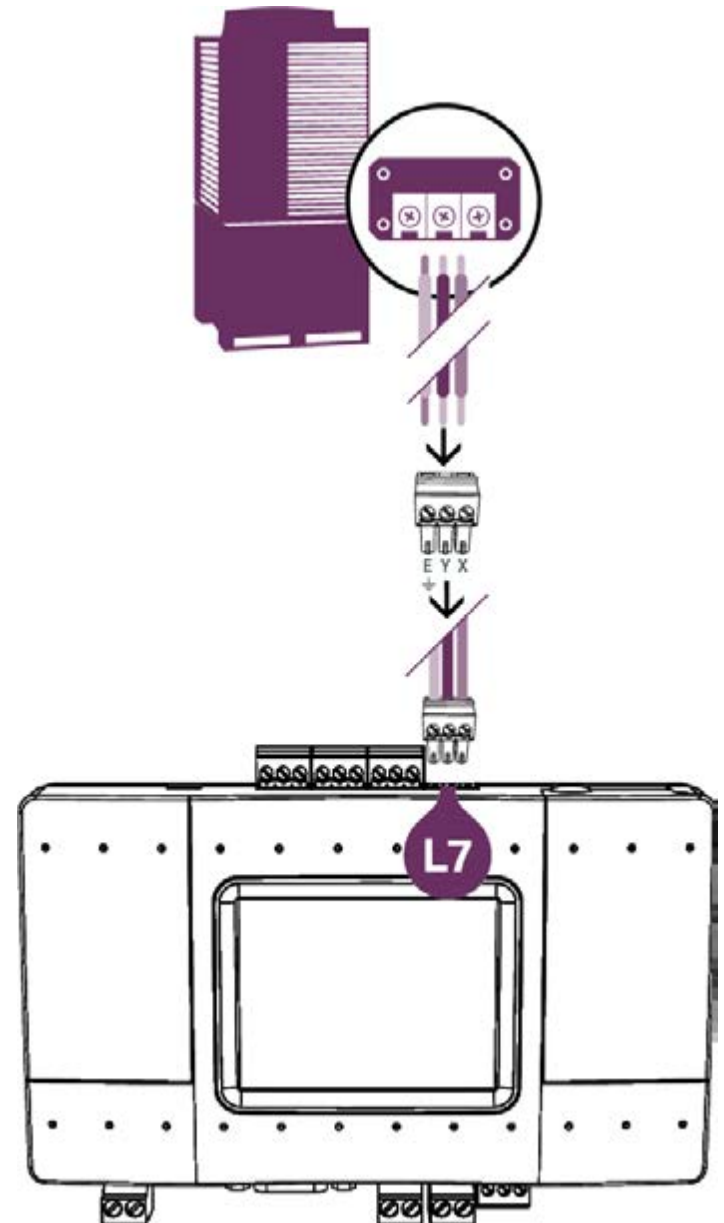

# HVAC Samsung VRF

## ① HVAC Communication Terminals

HVAC outdoor connection



\* See table on page 10 for Max connected indoors per model.

## ② Connecting to the line plug

Secure the cables in the L7 line plug.

## ③ Plugging to the CoolMaster device

Insert the plug in to the CoolMaster device L7 socket.

## ④ Check DIP Switches are set correctly

Dip switches setup for VRF HVAC system on L7.

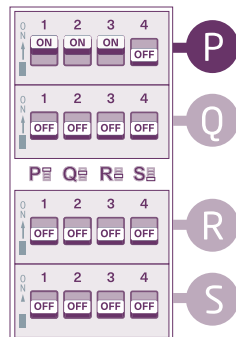

Samsung HVAC Terminal

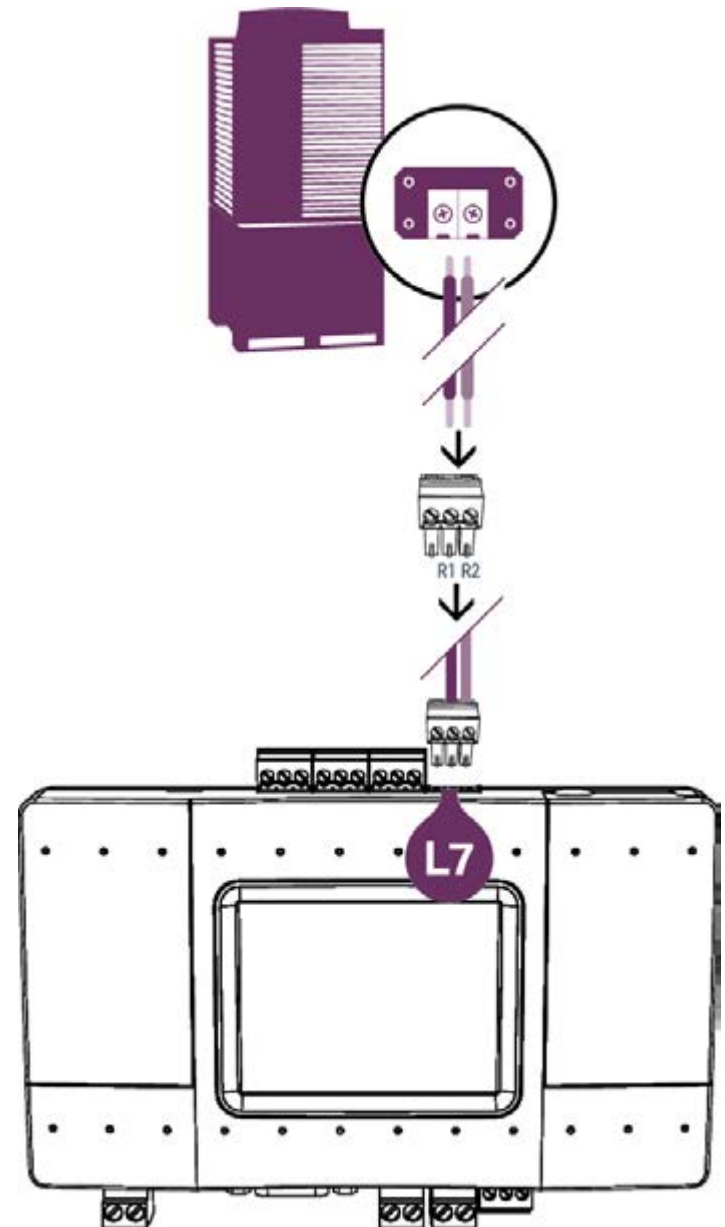



# HVAC Chigo VRF

## 1 HVAC Communication Terminals

HVAC outdoor connection



\* See table on page 10 for Max connected indoors per model.

## 2 Connecting to the line plug

Secure the cables in the L7 line plug.

## 3 Plugging to the CoolMaster device

Insert the plug in to the CoolMaster device L7 socket.

## 4 Check DIP Switches are set correctly

Dip switches setup for VRF HVAC system on L7.

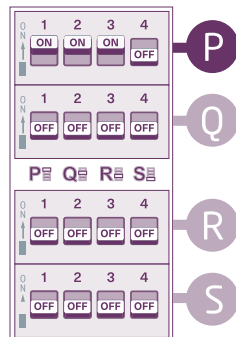

Chigo HVAC Terminal

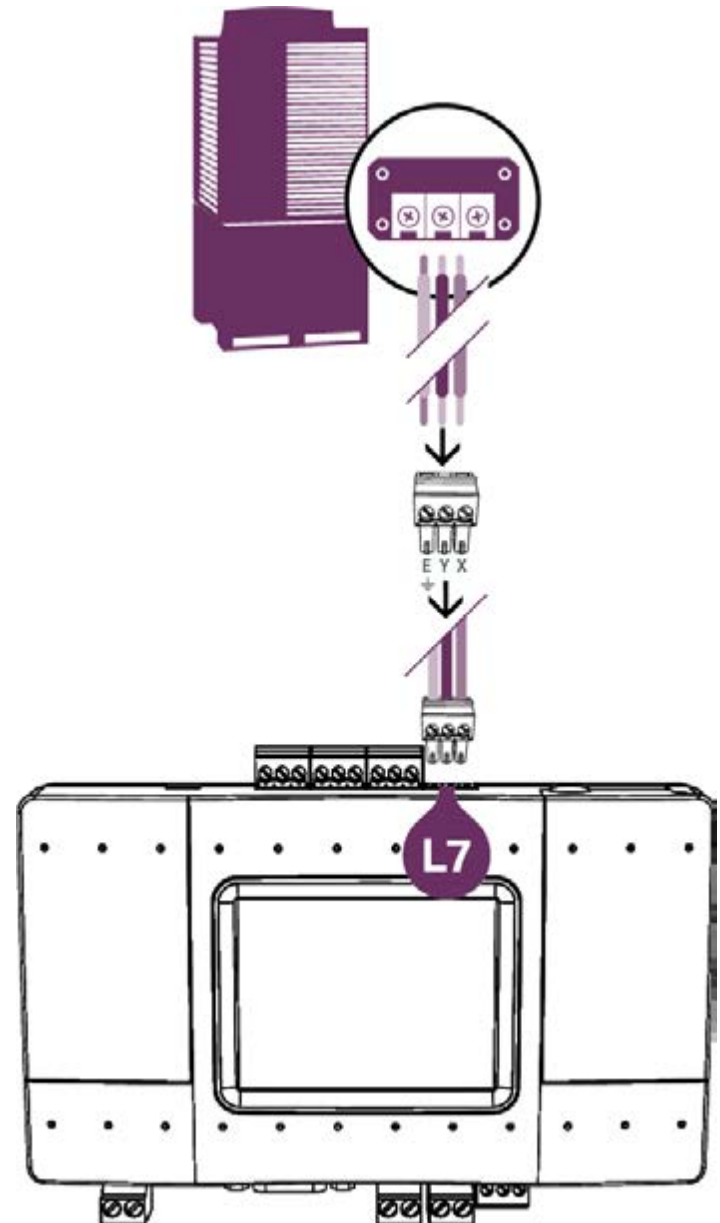

# HVAC Blue Star VRF

## ① HVAC Communication Terminals

HVAC outdoor connection



\* See table on page 10 for Max connected indoors per model.

## ② Connecting to the line plug

Secure the cables in the L7 line plug.

## ③ Plugging to the CoolMaster device

Insert the plug in to the CoolMaster device L7 socket.

## ④ Check DIP Switches are set correctly

Dip switches setup for VRF HVAC system on L7.

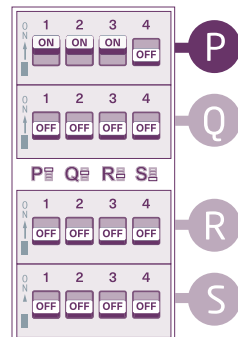

Blue Star HVAC Terminal

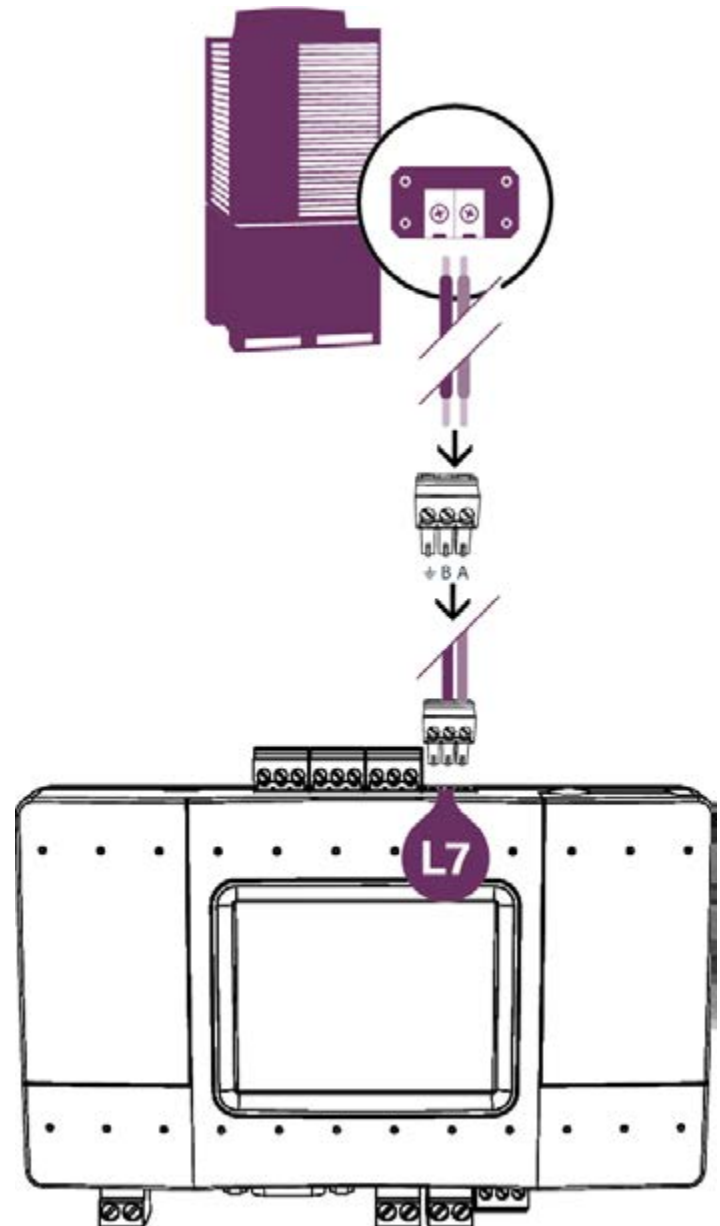

# HVAC TICA VRF

## 1 HVAC Communication Terminals

HVAC outdoor connection



\* See table on page 10 for Max connected indoors per model.

## 2 Connect Outdoor Unit

Secure wire in the A2 & B2 terminals on the Outdoor Unit.

## 3 Connect to CoolMaster device

Secure wire from Outdoor unit to the wire plug.  
Insert wire plug to CoolMaster device L7 socket.

## 4 Check DIP Switches are set correctly

Dip switches setup for VRF HVAC system on L7.

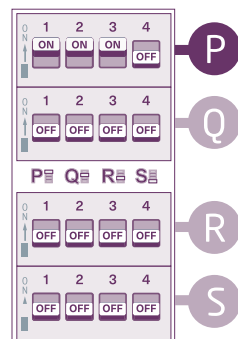
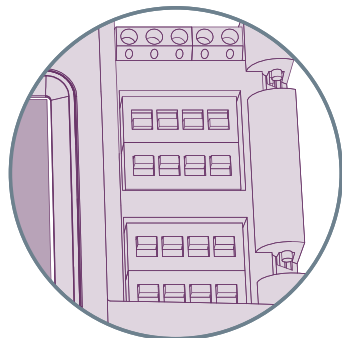

TICA Outdoor Terminals

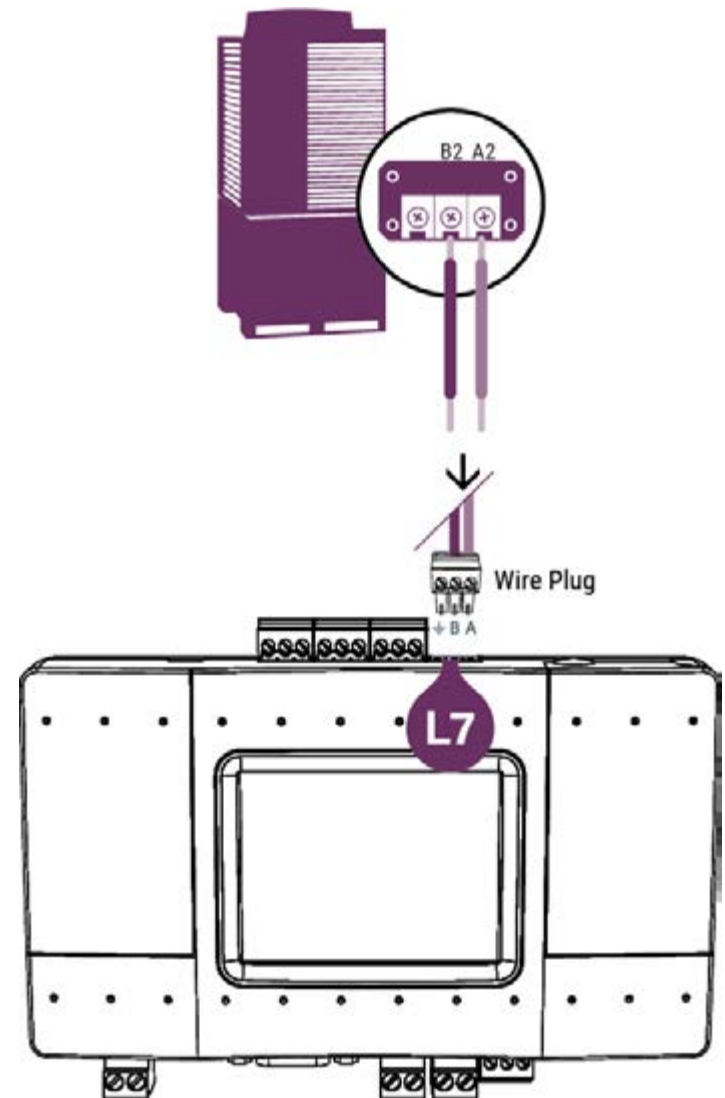

# HVAC Gree GMV5, GMV6 VRF

## ① HVAC Communication Terminals

HVAC outdoor connection

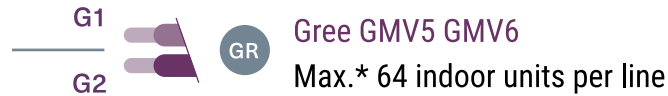

\* See table on page 10 for Max connected indoors per model.

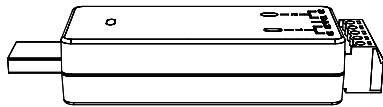

## ② Connecting to the CMNET-GR-GMV5/6

CoolAutomation USB Network Interface (CMNET-GR-GMV5/6) adapter is required for connecting up to two Gree GMV5/6 VRF lines. (Supplied by CoolAutomation)

This adapter includes a CAN bus 120  $\Omega$  resistor.

## ③ Plugging to the CoolMaster device

Insert the plug in to the CoolMaster device L8 (USB).

## ④ Check DIP Switches are set correctly

Dip switches setup for GMV5/6 VRF HVAC system on L8.

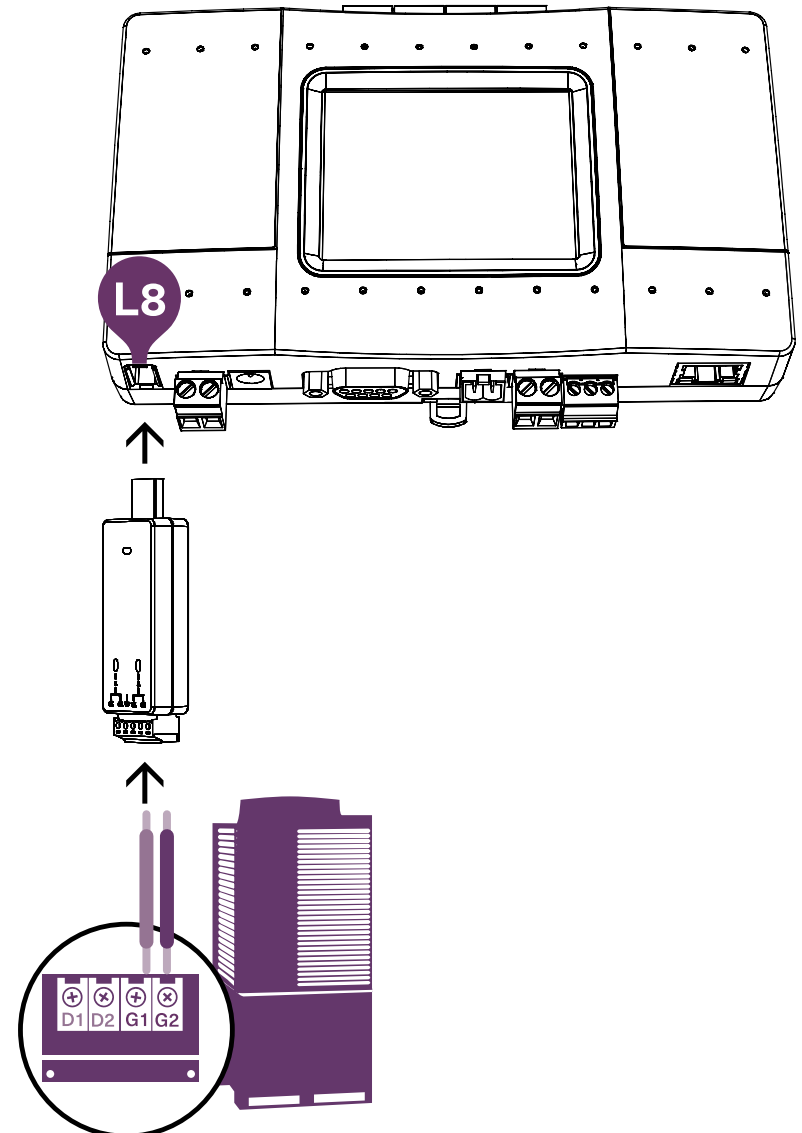
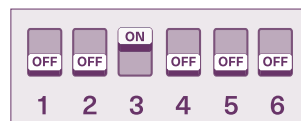
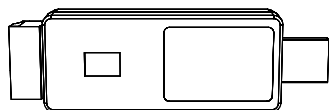

Gree GMV5/6 HVAC Terminal

# HVAC Fujitsu VRF

## ① HVAC Communication Terminals

HVAC outdoor connection



\* See table on page 10 for Max connected indoors per model.

## ② Connecting to the Echelon adapter

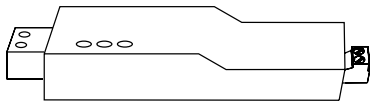

Echelon U10 USB Network Interface (TP/FT-10) adapter is required for connecting to Fujitsu VRF. (Not supplied by CoolAutomation)

## ③ Connect Echelon via USB Extension cable

Connect the USB Extension cable (A-Male to A-Female) to the Echelon adapter.

## ④ Plug in to the CoolMaster device L8

Insert the USB cable in to the L8 USB host.

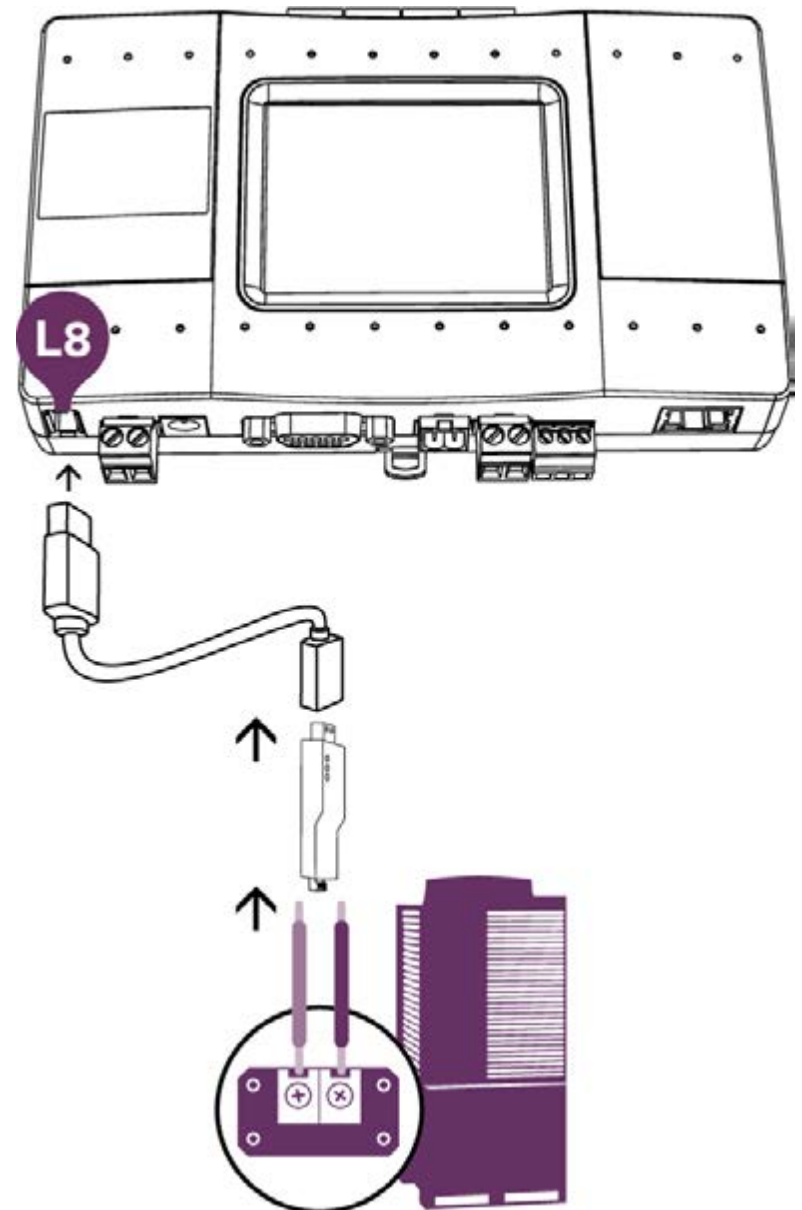

Fujitsu HVAC Terminal

# How to change the brand of a specific line

In order to change the HVAC brand type on a specific line, please follow the below procedure on CoolMaster device screen:

## 1 Go to Settings



## 2 Go to HVAC Line



## 3 Select the HVAC Line you want to configure



## 4 Configure the HVAC line type



## 5 Make sure the DIP switches are set properly for the brand (according to the details in the brand relevant section above)

## 6 You will also have a red warning message if DIP switch are set incorrect

## 7 Reset is required to make the change

# CoolMaster device installation complete

## CoolMaster device Unit screen

After successful installation, unit's screen will show all the detected indoor units and their statuses.

- 1 Active HVAC line (DK 9/10) (Groups/Units)
- 2 Inactive HVAC line
- 3 All ON/OFF operation button
- 4 Scrollbar
- 5 Connected indoor unit with it's address and Set-Point temperature indication.
- 6 Indoor unit operation button (on/off)
- 7 Service settings button
- 8 CoolMaster device MAC address
- 9 CoolMaster device IP address
- 10 CoolRemote connectivity status

-  Connected - Communicating
-  Connected - Idle
-  -12 Disconnected - with error code

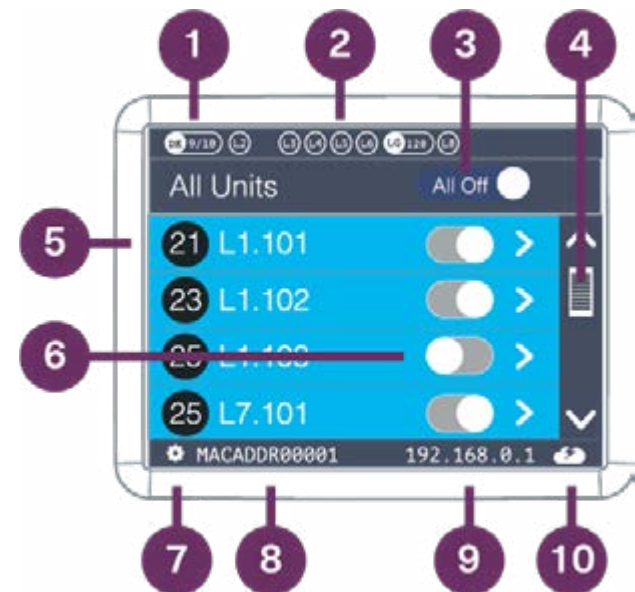

# Home Automation, BMS & iocControl App

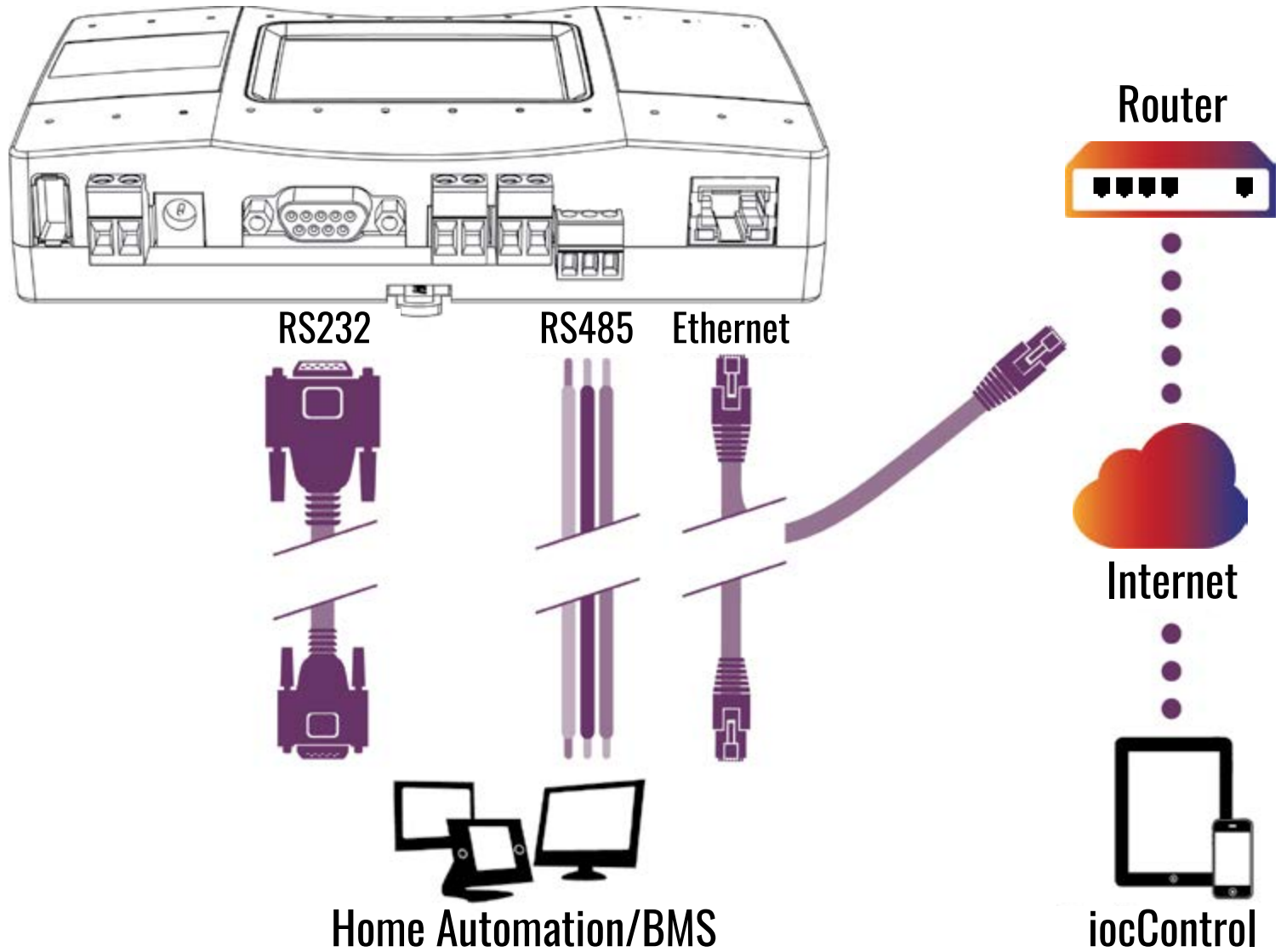



# Power Supply

## Option A

AC Power supply adapter  
(Included in the Box)

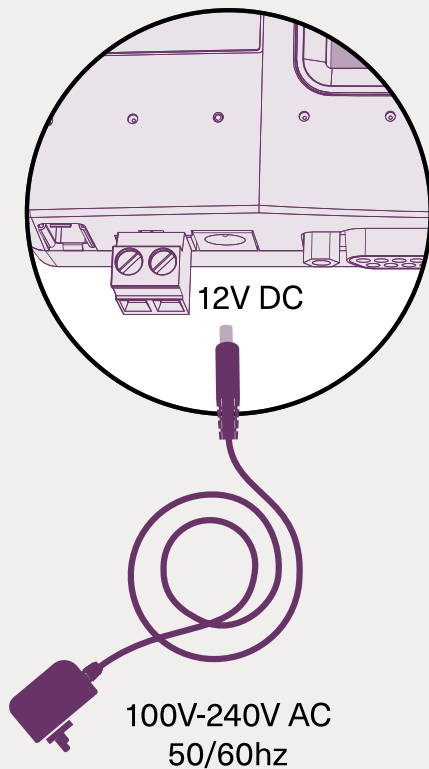

## Option B

Direct DC power supply

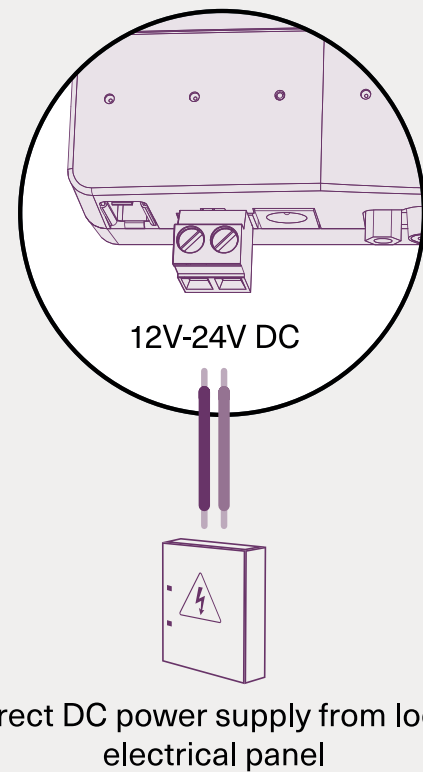



# Mounting on a DIN rail

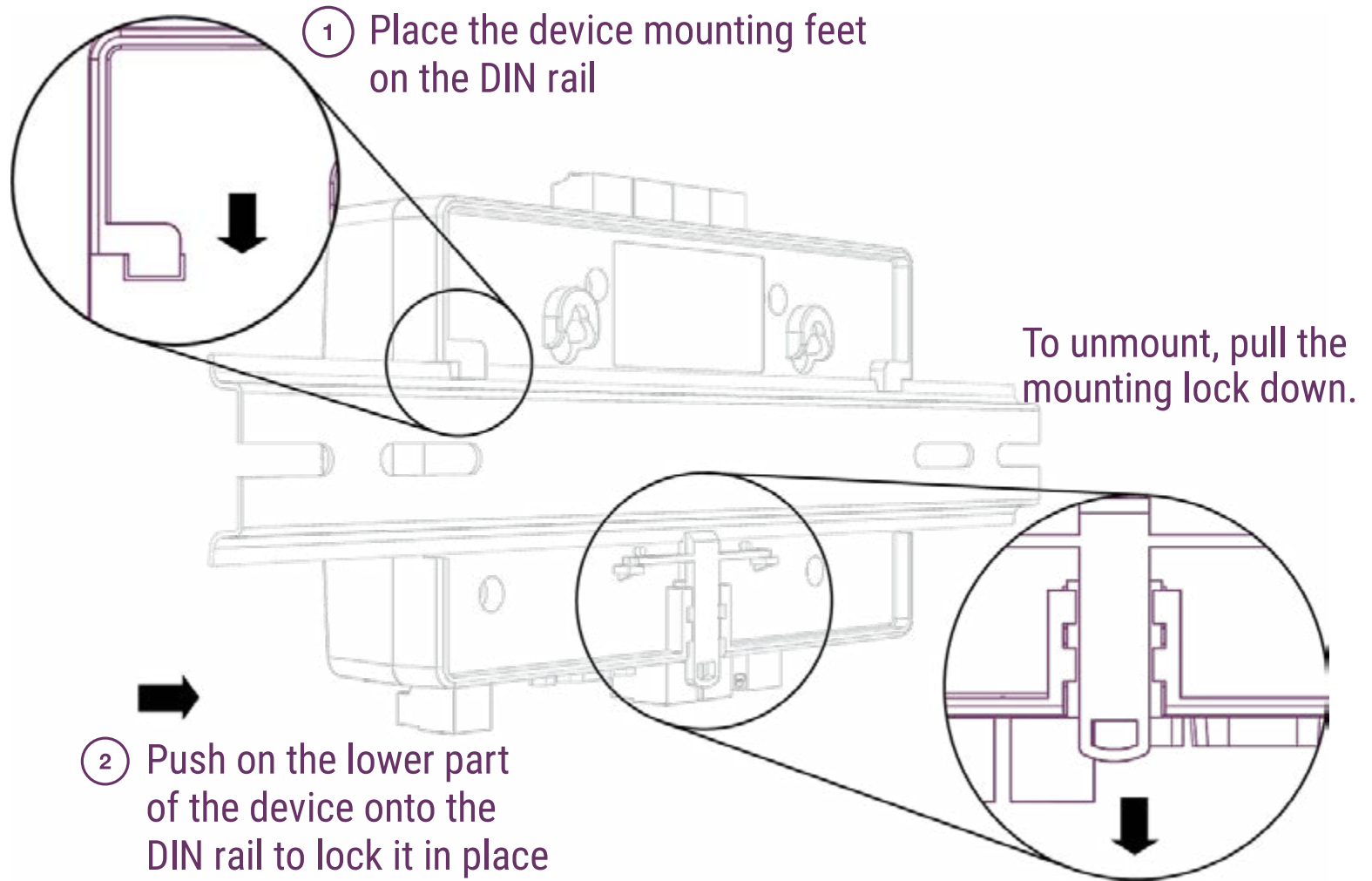

# Mounting on a wall

For mounting the CoolMaster device with wall screws, please see attached template with 1:1 dimensions.

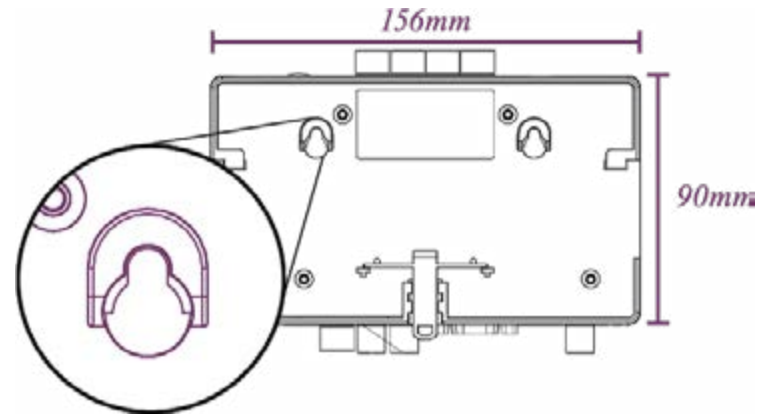

**1:1 SCALE MOUNTING TEMPLATE FOR WALL SCREWS**

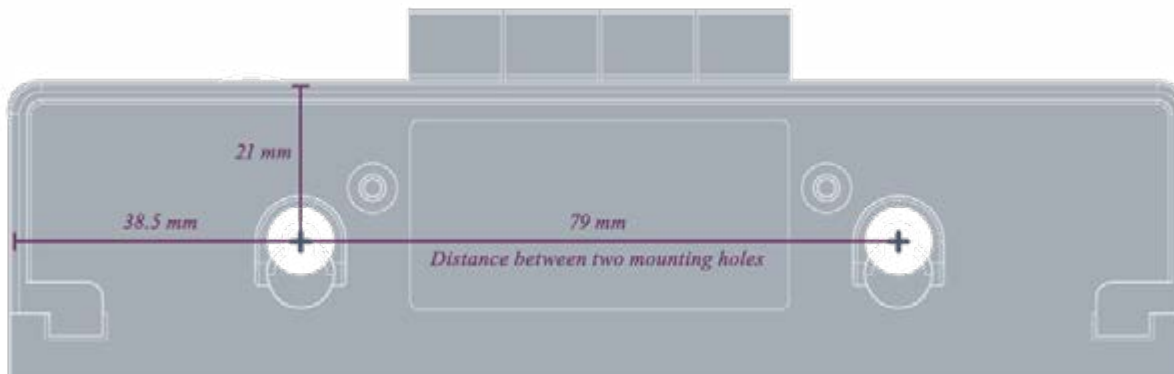

# Online Documentation and Support

Scan the QR code (on the box or back of the device) to get to

- Online Documentation
- Registration to the iocControl App
- Support

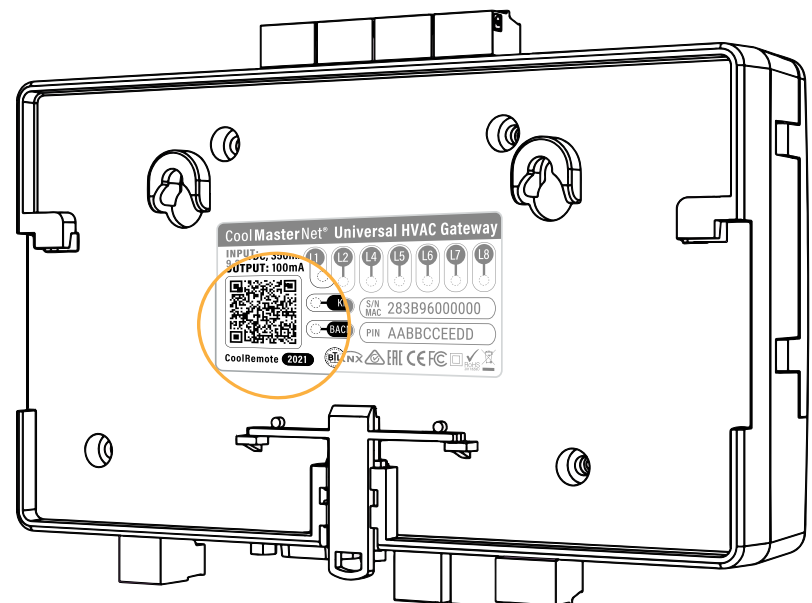
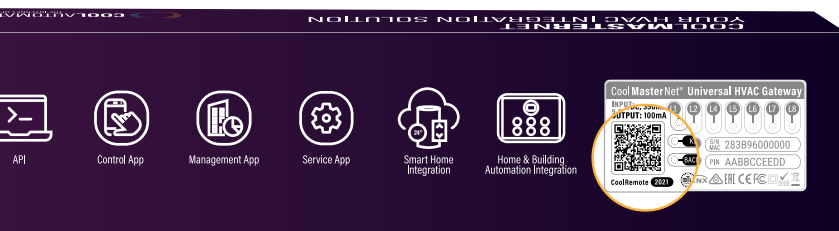

# Need more help?

Visit us at: <https://coolautomation.com/support>



**THE INTERNET  
OF CLIMATE**