

Thor series

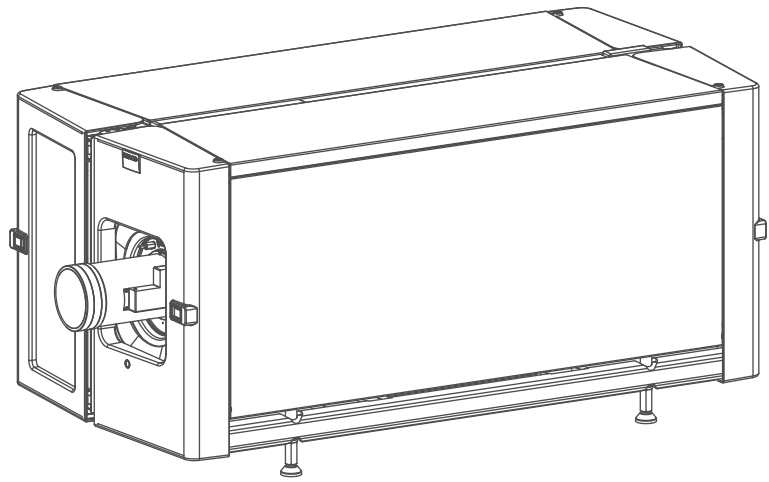

User manual

Barco NV
President Kennedypark 35, 8500 Kortrijk, Belgium
www.barco.com/en/support
www.barco.com

Changes

Barco provides this manual 'as is' without warranty of any kind, either expressed or implied, including but not limited to the implied warranties or merchantability and fitness for a particular purpose. Barco may make improvements and/or changes to the product(s) and/or the program(s) described in this publication at any time without notice.

This publication could contain technical inaccuracies or typographical errors. Changes are periodically made to the information in this publication; these changes are incorporated in new editions of this publication.

The latest edition of Barco manuals can be downloaded from the Barco web site www.barco.com or from the secured Barco web site <https://www.barco.com/en/signin>.

Copyright ©

All rights reserved. No part of this document may be copied, reproduced or translated. It shall not otherwise be recorded, transmitted or stored in a retrieval system without the prior written consent of Barco.

Federal Communications Commission (FCC Statement)

This equipment has been tested and found to comply with the limits for a class A digital device, pursuant to Part 15 of the FCC rules. These limits are designed to provide reasonable protection against harmful interference when the equipment is operated in a commercial environment. This equipment generates, uses, and can radiate radio frequency energy and, if not installed and used in accordance with the instruction manual, may cause harmful interference to radio communications. Operation of this equipment in a residential area may cause harmful interference, in which case the user will be responsible for correcting any interference at his own expense

Changes or modifications not expressly approved by the party responsible for compliance could void the user's authority to operate the equipment

EN55022/CISPR22 Class A ITE (Information Technology Equipment)

Class A ITE is a category of all other ITE which satisfies the class A ITE limits but not the class B ITE limits. Such equipment should not be restricted in its sale but the following warning shall be included in the instructions for use:

Warning : This is a class A product. In a domestic environment this product may cause radio interference in which case the user may be required to take adequate measures. Contact the installer.

Warning : This equipment is compliant with Class A of CISPR 32. In a residential environment this equipment may cause radio interference.

Product Security Incident Response

As a global technology leader, Barco is committed to deliver secure solutions and services to our customers, while protecting Barco's intellectual property. When product security concerns are received, the product security incident response process will be triggered immediately. To address specific security concerns or to report security issues with Barco products, please inform us via contact details mentioned on <https://www.barco.com/psirt>. To protect our customers, Barco does not publically disclose or confirm security vulnerabilities until Barco has conducted an analysis of the product and issued fixes and/or mitigations.

Patent protection

Please refer to www.barco.com/about-barco/legal/patents

Guarantee and Compensation

Barco provides a guarantee relating to perfect manufacturing as part of the legally stipulated terms of guarantee. On receipt, the purchaser must immediately inspect all delivered goods for damage incurred during transport, as well as for material and manufacturing faults Barco must be informed immediately in writing of any complaints.

The period of guarantee begins on the date of transfer of risks, in the case of special systems and software on the date of commissioning, at latest 30 days after the transfer of risks. In the event of justified notice of complaint, Barco can repair the fault or provide a replacement at its own discretion within an appropriate period. If this measure proves to be impossible or unsuccessful, the purchaser can demand a reduction in the purchase price or cancellation of the contract. All other claims, in particular those relating to compensation for

direct or indirect damage, and also damage attributed to the operation of software as well as to other services provided by Barco, being a component of the system or independent service, will be deemed invalid provided the damage is not proven to be attributed to the absence of properties guaranteed in writing or due to the intent or gross negligence or part of Barco.

If the purchaser or a third party carries out modifications or repairs on goods delivered by Barco, or if the goods are handled incorrectly, in particular if the systems are operated incorrectly or if, after the transfer of risks, the goods are subject to influences not agreed upon in the contract, all guarantee claims of the purchaser will be rendered invalid. Not included in the guarantee coverage are system failures which are attributed to programs or special electronic circuitry provided by the purchaser, e.g. interfaces. Normal wear as well as normal maintenance are not subject to the guarantee provided by Barco either.

The environmental conditions as well as the servicing and maintenance regulations specified in this manual must be complied with by the customer.

Software License Agreement

You should carefully read the following terms and conditions before using this software. Your use of this software indicates your acceptance of this license agreement and warranty.

Terms and Conditions:

1. No redistribution of the software is allowed.
2. Reverse-Engineering. You may not reverse engineer, decompile, disassemble or alter this software product.

Disclaimer of Warranty:

This software and the accompanying files are sold "as is" and without warranties as to performance or merchantability or any other warranties whether expressed or implied. In no event shall Barco be liable for damage of any kind, loss of data, loss of profits, business interruption or other pecuniary loss arising directly or indirectly. Any liability of the seller will be exclusively limited to replacement of the product or refund of purchase price.

GNU-GPL code

If you would like a copy of the GPL source code contained in this product shipped to you on CD, please contact Barco. The cost of preparing and mailing a CD will be charged.

Trademarks

Brand and product names mentioned in this manual may be trademarks, registered trademarks or copyrights of their respective holders. All brand and product names mentioned in this manual serve as comments or examples and are not to be understood as advertising for the products or their manufacturers.

Table of contents

1 Welcome	7
1.1 About this manual	8
2 Safety Information	9
2.1 General considerations	10
2.2 Safety training to be provided by the installer	10
2.3 Important safety instructions	11
2.4 Product safety labels	14
2.5 High Brightness precautions: Hazard Distance (HD)	16
2.6 HD for fully enclosed projection systems	18
2.7 HD in function of modifying optics	20
3 Lenses & Lens selection	21
3.1 Available lenses	22
3.2 Lens selection	22
3.3 Lens installation	23
3.4 Lens removal	25
3.5 Lens shift, zoom & focus	26
4 Input & Communication	29
4.1 Introduction	30
4.2 Projector Status	30
4.3 Laser Status	31
4.4 Local Keypad	32
4.5 Cinema Controller	34
5 ICMP	37
5.1 ICMP introduction	39
5.2 ICMP HDD	40
5.3 ICMP communication ports	42
5.4 ICMP source input ports	43
5.5 ICMP DisplayPort specifications	44
5.6 ICMP SDI specifications	46
5.7 ICMP HDMI 2.0 specifications	49
5.8 ICMP HDMI 1.4 specifications	52
5.9 ICMP status LEDs	55
5.10 ICMP HDD status LEDs	56
5.11 ICMP device certificate	57
5.12 ICMP configuration via Communicator	59
5.13 ICMP reset	60
5.14 Obtaining the Barco ICMP certificate	61

5.15	Removing a HDD from the ICMP	62
5.16	Installing a HDD into the ICMP	63
6	Starting up	65
6.1	Switching the Thor ON	66
6.2	Switching the Thor OFF	67
6.3	Projector ON/OFF cycle explained	67
A	Specifications	71
A.1	Specifications of the Thor	72
A.2	Specifications of the Thor+	73
A.3	Specifications of the ICMP	74
A.4	Dimensions of the Thor	76
A.5	Technical Regulations	77
B	Environmental information	79
B.1	Disposal information	80
B.2	China RoHS compliance	80
B.3	Taiwan RoHS compliance	82
B.4	Turkey RoHS compliance	82
B.5	Hazards	83
B.6	Contact information	83
B.7	Production address	83
B.8	Download Product Manual	83
	Glossary	85
	Index	89

Welcome

1

Congratulations

May we congratulate you on your purchase of a Barco Thor series! It is our sincere wish that this digital projector meets up to your every expectation and that you thereby take a little time to page through this important manual. Familiarizing yourself with it's features, important safety instructions and necessary maintenance actions, will ensure you enjoy many years of reliable, trouble-free high quality performance.

Overview

- About this manual

1.1 About this manual

How to use this manual?

We suggest that you read over this manual before you install and use your Thor series. Inside it, you will find important information regarding safety, installation and maintenance. We urge even the experienced user to take the necessary time to page through this manual. We believe everyone will benefit from this manual. Not in the least our editors, who will sleep more comfortably knowing their efforts have had their effect.

What's expected from you?

For your safety and in the interest of reliable, trouble-free, high quality performance, we urge the user/operator/service technician, to follow all instructions precisely. Follow the maintenance recommendations and procedures in this manual step by step to keep your projector in excellent condition. Doing so will directly impact the lifetime of your Thor series.

If, after having read over these instructions, you experience difficulties, please contact your Barco service partner! They will do their best to assist you and get you up and running as soon as possible.

“Treat your Thor series as your own and it will reward you with many trouble-free years of exquisite digital entertainment pleasure!”

Safety Information

2

About this chapter

Read this chapter attentively. It contains important information to prevent personal injury while installing and using your Thor. Furthermore, it includes several cautions to prevent damage to your Thor. Ensure that you understand and follow all safety guidelines, safety instructions and warnings mentioned in this chapter before installing and using the Thor. After this chapter, additional “warnings” and “cautions” are given depending on the procedure. Read and follow these “warnings” and “cautions” as well.

Clarification of the term “Thor series” used in this document

When referring in this document to the term “Thor series” means that the content is applicable for following Barco products:

- THOR
- THOR+

Model certification name

- Thor : DP4K-20LHC
- Thor+: DP4K-40LHC



Barco provides a guarantee relating to perfect manufacturing as part of the legally stipulated terms of guarantee. Observing the specification mentioned in this chapter is critical for projector performance. Neglecting this can result in loss of warranty.

Overview

- General considerations
- Safety training to be provided by the installer
- Important safety instructions
- Product safety labels
- High Brightness precautions: Hazard Distance (HD)
- HD for fully enclosed projection systems
- HD in function of modifying optics

2.1 General considerations

General safety instructions

- Before operating this equipment please read this manual thoroughly and retain it for future reference.
- Installation and preliminary adjustments should be performed by qualified Barco personnel or by authorized Barco service dealers.
- All warnings on the projector and in the documentation manuals should be adhered to.
- All instructions for operating and use of this equipment must be followed precisely.
- All local installation codes should be adhered to.

Notice on safety

This equipment is built in accordance with the requirements of the international safety standards IEC60950-1, EN60950-1, UL60950-1 and CAN/CSA C22.2 No.60950-1, which are the safety standards of information technology equipment including electrical business equipment. These safety standards impose important requirements on the use of safety critical components, materials and insulation, in order to protect the user or operator against risk of electric shock and energy hazard and having access to live parts. Safety standards also impose limits to the internal and external temperature rises, radiation levels, mechanical stability and strength, enclosure construction and protection against the risk of fire. Simulated single fault condition testing ensures the safety of the equipment to the user even when the equipment's normal operation fails.

Notice on optical radiation

This projector embeds extremely high brightness (radiance) lasers; this laser light is processed through the projector's optical path. Native laser light is not accessible by the end user in any use case. The light exiting the projection lens has been diffused within the optical path, representing a larger source and lower radiance value than native laser light. Nevertheless the projected light represents a significant risk for the human eye and skin when exposed directly within the beam. This risk is not specifically related to the characteristics of laser light but solely to the high thermal induced energy of the light source; which is equivalent with lamp based systems.

Thermal retinal eye injury is possible when exposed within the Hazard Distance (HD). The HD is defined from the projection lens surface towards the position of the projected beam where the irradiance equals the maximum permissible exposure as described in the chapter "Hazard Distance".



WARNING: No direct exposure to the beam within the hazard distance shall be permitted, RG3 (Risk Group 3) IEC 62471-5:2015



CAUTION: Use of controls or adjustments or performance of procedures other than those specified herein may result in hazardous radiation exposure.

Owner's record

The part number and serial number are printed on a label which is stuck on the respective part. Record these numbers in the spaces provided below. Refer to them whenever you call upon your Barco dealer regarding this product.

Product article number	
Product serial number	
Dealer	

2.2 Safety training to be provided by the installer



WARNING: The installer is responsible that the user is instructed. The user will sign a document to confirm that the instructions have been received and understood.

Users definition

The Thor series is intended for persons who have been instructed and trained by a skilled person (installer or service personnel) to identify energy sources that may cause injury and to take precautions to avoid unintentional contact with or exposure to those energy sources.

The skilled person must instruct the user about:

- High intensity light beam. The user must respect the exclusion zone, based on the light beam Hazard Distance (HD).
- Dangerous energy sources inside the projector. The user is not allowed to remove any cover from the projector.
- The installation, maintenance or service is for skilled persons only.
- The requirements for a **restricted access location**, an **exclusion zone** and a **restriction zone**.

Restricted access location

To protect untrained persons and children, the projector must be installed in a **restricted access location**. The definition of a **restricted access location** is a location for equipment where both of the following paragraphs apply:

- Access can only be gained by skilled persons (installer or service personnel) or persons who have been instructed and trained by a skilled person. The persons must have been instructed about the reasons for the restriction applied to the location and about the precautions that shall be taken.
- Access is only possible through the use of the tool or lock and key, or other means of security, and is controlled by the authority responsible for the location.

Why a restricted access location: This is a RG3 product. Based on international requirements, no person is allowed to enter the projected beam within the zone between the projection lens and the related Hazard Distance (HD). This shall be physically impossible by creating sufficient separation height or by placing optional barriers. Within the restricted area operator training is considered sufficient. The applicable separation heights are discussed in "High Brightness precautions: Hazard Distance (HD)", page 16.

Exclusion zone

The projector radiates heat on its external surfaces and from ventilation ducts during normal operation. Exposing flammable or combustible materials into close proximity of this projector could result in the spontaneous ignition of that material, resulting in a fire. For this reason, it is absolutely necessary to leave an exclusion zone around all external surfaces of the projector whereby no flammable or combustible materials are present:

- The exclusion zone must not be less than 40 cm (16 in).

Restriction zone

To protect untrained users and children against high intensity light beams, the light beam Hazard Distance (HD) shall be taken into account.

2.3 Important safety instructions

To prevent the risk of electrical shock

- Installation according to the local electrical code and regulations by qualified technical personnel only. Do not defeat the purpose of the grounding.
- A readily accessible disconnect device must be incorporated externally to the equipment for removal of the power to the projector mains terminals.
- Warning: High leakage current. Earth connection essential before connecting supply.
- Do not allow anything to rest on the power cord. Do not locate this projector where persons will walk on the cord.
- Do not operate the projector with a damaged cord or if the projector has been dropped or damaged - until it has been examined and approved for operation by a qualified service technician.
- Position the cord so that it will not be tripped over, pulled, or contact hot surfaces.
- If an extension cord is necessary, a cord with a current rating at least equal to that of the projector should be used. A cord rated for less amperage than the projector may overheat.

- Never push objects of any kind into this projector through cabinet slots as they may touch dangerous voltage points or short circuit parts that could result in a risk of fire or electrical shock.
- Do not expose this projector to rain or moisture.
- Do not immerse or expose this projector in water or other liquids.
- Do not spill liquid of any kind on this projector.
- Should any liquid or solid object fall into the cabinet, unplug the set and have it checked by qualified service personnel before resuming operations.
- Do not disassemble this projector, always take it to a trained service person when service or repair work is required.
- Do not use an accessory attachment which is not recommended by the manufacturer.
- Lightning - For added protection for this video product during a lightning storm, or when it is left unattended and unused for long periods of time, remove all power from the projector. This will prevent damage to the projector due to lightning and AC power-line surges.

To prevent fire hazard

- Do not place flammable or combustible materials near the projector!
- Barco large screen projection products are designed and manufactured to meet the most stringent safety regulations. This projector radiates heat on its external surfaces and from ventilation ducts during normal operation, which is both normal and safe. Exposing flammable or combustible materials into close proximity of this projector could result in the spontaneous ignition of that material, resulting in a fire. For this reason, it is absolutely necessary to leave an "exclusion zone" around all external surfaces of the projector whereby no flammable or combustible materials are present. The exclusion zone must be not less than 40 cm (16") for all DLP Cinema projectors. The exclusion zone on the lens side must be at least 5 m. Do not cover the projector or the lens with any material while the projector is in operation. Keep flammable and combustible materials away from the projector at all times. Mount the projector in a well ventilated area away from sources of ignition and out of direct sun light. Never expose the projector to rain or moisture. In the event of fire, use sand, CO₂ or dry powder fire extinguishers. Never use water on an electrical fire. Always have service performed on this projector by authorized Barco service personnel. Always insist on genuine Barco replacement parts. Never use non-Barco replacement parts as they may degrade the safety of this projector.
- Slots and openings in this equipment are provided for ventilation. To ensure reliable operation of the projector and to protect it from overheating, these openings must not be blocked or covered. The openings should never be blocked by placing the projector too close to walls, or other similar surface. This projector should never be placed near or over a radiator or heat register. This projector should not be placed in a built-in installation or enclosure unless proper ventilation is provided.
- Projection rooms must be well ventilated or cooled in order to avoid build up of heat. It is necessary to vent hot exhaust air from projector and cooling system (chiller units) to the outside of the building.

To prevent battery explosion

- Danger of explosion if battery is incorrectly installed.
- Replace only with the same or equivalent type recommended by the manufacturer.
- For disposal of used batteries, always consult federal, state, local and provincial hazardous waste disposal rules and regulations to ensure proper disposal.

To prevent personal injury

- To prevent injury and physical damage, always read this manual and all labels on the system before powering the projector or adjusting the projector.
- Do not underestimate the weight of the projector. The projector weights ± 240 kg (± 529 lbs). To prevent personal injury a hoisting tool should be used to lift the projector.
- To prevent injury, ensure that the lens, cooling system and all cover plates are correctly installed. See installation procedures.
- Warning: high intensity light beam. NEVER look into the lens ! High luminance could result in damage to the eye.
- Do not place this equipment on an unstable cart, stand, or table. The product may fall, causing serious damage to it and possible injury to the user.
- Lenses, shields or screens shall be changed if they have become visibly damaged to such an extent that their effectiveness is impaired. For example by cracks or deep scratches.
- When the projected light causes a dangerous situation the operator must hit the beam stop button which is located close to the control panel. The beam stop removes all power from the laser power supplies.

- Don't put your hand in front of the beam.
- Do not clean the port window when the projector is switched on.

On servicing

- Do not attempt to service this product yourself, as opening or removing covers may expose you to dangerous voltage potentials and risk of electric shock.
- Refer all servicing to qualified service personnel.
- Attempts to alter the factory-set internal controls or to change other control settings not specially discussed in this manual can lead to permanent damage to the projector and cancellation of the warranty.
- Remove all power from the projector and refer servicing to qualified service technicians under the following conditions:
 - When the power cord or plug is damaged or frayed.
 - If liquid has been spilled into the equipment.
 - If the product has been exposed to rain or water.
 - If the product does not operate normally when the operating instructions are followed. Adjust only those controls that are covered by the operating instructions since improper adjustment of the other controls may result in damage and will often require extensive work by a qualified technician to restore the product to normal operation.
 - If the product has been dropped or the cabinet has been damaged.
 - If the product exhibits a distinct change in performance, indicating a need for service.
- Replacement parts: When replacement parts are required, be sure the service technician has used original Barco replacement parts or authorized replacement parts which have the same characteristics as the Barco original part. Unauthorized substitutions may result in degraded performance and reliability, fire, electric shock or other hazards. Unauthorized substitutions may void warranty.
- Safety check: Upon completion of any service or repairs to this projector, ask the service technician to perform safety checks to determine that the product is in proper operating condition.

To prevent projector damage

- The air filters of the projector must be cleaned or replaced on a regular basis. Cleaning the booth area would be monthly-minimum. Neglecting this could result in disrupting the air flow inside the projector, causing overheating. Overheating may lead to the projector shutting down during operation.
- The projector must always be installed in a manner which ensures free flow of air into its air inlets.
- If more than one projector is installed in a common projection booth, the exhaust air flow requirements are valid for EACH individual projector system. Note that inadequate air extraction or cooling will result in decreased life expectancy of the projector as a whole as well as causing premature failure of the lasers.
- In order to ensure that correct airflow is maintained, and that the projector complies with Electromagnetic Compatibility (EMC) and safety requirements, it should always be operated with all of its covers in place.
- Slots and openings in the cabinet are provided for ventilation. To ensure reliable operation of the product and to protect it from overheating, these openings must not be blocked or covered. The openings should never be blocked by placing the product on a bed, sofa, rug, or other similar surface. This product should never be placed near or over a radiator or heat register. The device should not be placed in a built-in installation or enclosure unless proper ventilation is provided.
- Ensure that nothing can be spilled on, or dropped inside the projector. If this does happen, switch off and remove all power from the projector. Do not operate the projector again until it has been checked by qualified service personnel.
- Do not block the projector cooling fans or free air movement around the projector. Loose papers or other objects may not be nearer to the projector than 10 cm (4") on any side.
- Proper operation of the projector can only be guaranteed in table mounting. It is not permitted to use the projector in another position. See installation procedure for correct installation.
- **Special care for Laser Beams:** Special care should be used when DLP projectors are used in the same room as high power laser equipment. Direct or indirect hitting of a laser beam on to the lens can severely damage the Digital Mirror Devices™ in which case there is a loss of warranty.
- Never place the projector in direct sunlight. Sunlight on the lens can severely damage the Digital Mirror Devices™ in which case there is a loss of warranty.
- Save the original shipping carton and packing material. They will come in handy if you ever have to ship your equipment. For maximum protection, repack your set as it was originally packed at the factory.
- Disconnect the power to the projectors mains terminals before cleaning. Do not use liquid cleaners or aerosol cleaners. Use a damp cloth for cleaning. Never use strong solvents, such as thinner or benzine or

abrasive cleaners, since these will damage the cabinet. Stubborn stains may be removed with a cloth lightly dampened with mild detergent solution.







- To ensure the highest optical performance and resolution, the projection lenses are specially treated with an anti-reflective coating, therefore, avoid touching the lens. To remove dust on the lens, use a soft dry cloth. For lens cleaning follow the instructions precisely as stipulated in the projector manual.
- Rated maximum ambient temperature, $t_a = 30^\circ\text{C}$ (86°F).

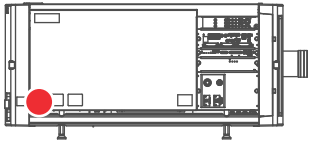

Safety Data Sheets for Hazardous Chemicals

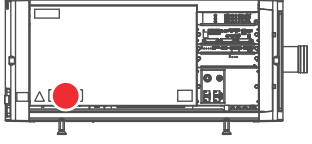
For safe handling information on chemical products, consult the Safety Data Sheet (SDS). SDSs are available upon request via safetydatasheets@barco.com.

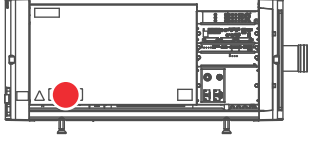
2.4 Product safety labels

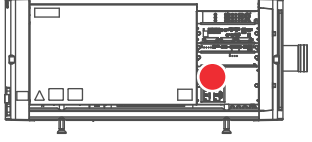
Light beam related safety labels

Label image	Label description	Label location
	Hazard RG3: optical radiation warning symbol	
	WARNING! DO NOT LOOK INTO THE LIGHT BEAM NO DIRECT EYE EXPOSURE TO THE BEAM IS PERMITTED. RG3 IEC EN 62471-5:2015 CLASS 1 IEC EN 60825-1:2014 HAZARD DISTANCE: CONSULT SAFETY MANUAL. COMPLIES WITH 21 CFR 1040 EXCEPT WITH RESPECT TO THOSE CHARACTERISTICS AUTHORIZED BY VARIANCE NUMBER 2014-V-0285 DATED APRIL 14, 2016 RISK GROUP 3 LIP IEC 62471:2006	
	警告！勿观看光束 眼睛勿直接接触可允许暴露的光束 (RG3 IEC EN 62471-5:2015 CLASS 1 IEC EN 60825-1:2014) 危害距离：请参考安全手册 DANGER! NE PAS REGARDER LE FAISCEAU EVITER TOUTE EXPOSITION DIRECTE DES YEUX AU FAISCEAU RG3 IEC EN 62471-5:2015 CLASS 1 IEC EN 60825-1:2014 DISTANCE DE SECURITE : CONSULTER LE MANUEL DE SECURITE	
	Beam stop. Arrêt de faisceau. 光束衰减器	

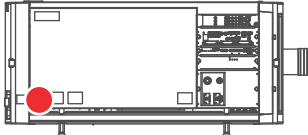
Label image	Label description	Label location
	Enable key. Clé de active. 启动钥匙	
	Hazard RG3: not for household use symbol	

Electric related safety labels

Label image	Label description	Label location
	Disconnect the power to the unit mains terminals and unplug power cord at UPS inlet for removal of all power from the unit. WARNING : HIGH LEAKAGE CURRENT EARTH CONNECTION ESSENTIAL BEFORE CONNECTING SUPPLY SEE INSTALLATION INSTRUCTIONS BEFORE CONNECTING TO THE SUPPLY. Déconnecter l'alimentation des bornes du réseau et déconnecter le câble de la prise UPS pour la coupure de toute l'alimentation de l'appareil. ATTENTION : COURANT DE FUITE ÉLEVÉ RACCORDEMENT À LA TERRE INDISPENSABLE AVANT LE RACCORDEMENT AU RÉSEAU VOIR LA NOTICE D'INSTALLATION AVANT DE RACCORDER AU RÉSEAU. 断开放映机主电源端的电源并从UPS电源接入插座上拔下电源线. 警告：大漏，电流在接通电源之前必须先接地. 在与电源连接前请查看安装说明书.	 (located behind cover)
	UPS INLET : 200-240V 6A max. 50-60Hz UPS OUTLET : ONLY FOR CONNECTION TO UPS INLET WARNING : Disconnect the power to the mains terminals and unplug power cord at UPS inlet for removal of all power from the unit. ATTENTION : Eteindre et déconnecter le câble dans la prise UPS pour la coupure de toute l'alimentation de l'appareil UPS 电源输入插座 : 200-240V 最大电流 6A 50-60Hz UPS 输出插座 : 仅用于连接 UPS 电源输入插座 警告 断开放映机主电源端的电源并从UPS电源接入插座上拔下电源线, 切断放映机的所有电源.	

2.5 High Brightness precautions: Hazard Distance (HD)

HD



Hazard Distance (HD) is the distance measured from the projection lens at which the intensity or the energy per surface unit becomes lower than the applicable exposure limit on the cornea or on the skin. The light beam is considered (to be) unsafe for exposure if the distance from a person to the light source is less than the HD.

Restriction Zone (RZ) based on the HD

The HD depends on the amount of lumens produced by the projector and the type of lens installed. See next chapter “HD in function of modifying optics”, page 20.

To protect untrained end users (as cinema visitors, spectators) the installation shall comply with the following installation requirements: Operators shall control access to the beam within the hazard distance or install the product at the height that will prevent spectators' eyes from being in the hazard distance. Radiation levels in excess of the limits will not be permitted at any point less than 2.0 meter (SH) above any surface upon which persons other than operators, performers, or employees are permitted to stand or less than 1.0 meter (SW) lateral separation from any place where such persons are permitted to be. In environments where unrestrained behavior is reasonably foreseeable, the minimum separation height should be greater than or equal to 3.0 meter to prevent potential exposure, for example by an individual sitting on another individual's shoulders, within the HD.

These values are minimum values and are based on the guidance provided in IEC 62471-5:2015 section 6.6.3.5.

The installer and user must understand the risk and apply protective measures based upon the hazard distance as indicated on the label and in the user information. Installation method, separation height, barriers, detection system or other applicable control measure shall prevent hazardous eye access to the radiation within the hazard distance.

For example, projectors that have a HD greater than 1 m and emit light into an uncontrolled area where persons may be present should be positioned in accordance with “the fixed projector installation” parameters, resulting in a HD that does not extend into the audience area unless the beam is at least 2.0 meter above the floor level. In environments where unrestrained behavior is reasonably foreseeable, the minimum separation height should be greater than or equal to 3.0 meter to prevent potential exposure, for example by an individual sitting on another individual's shoulders, within the HD. Sufficiently large separation height may be achieved by mounting the image projector on the ceiling or through the use of physical barriers.

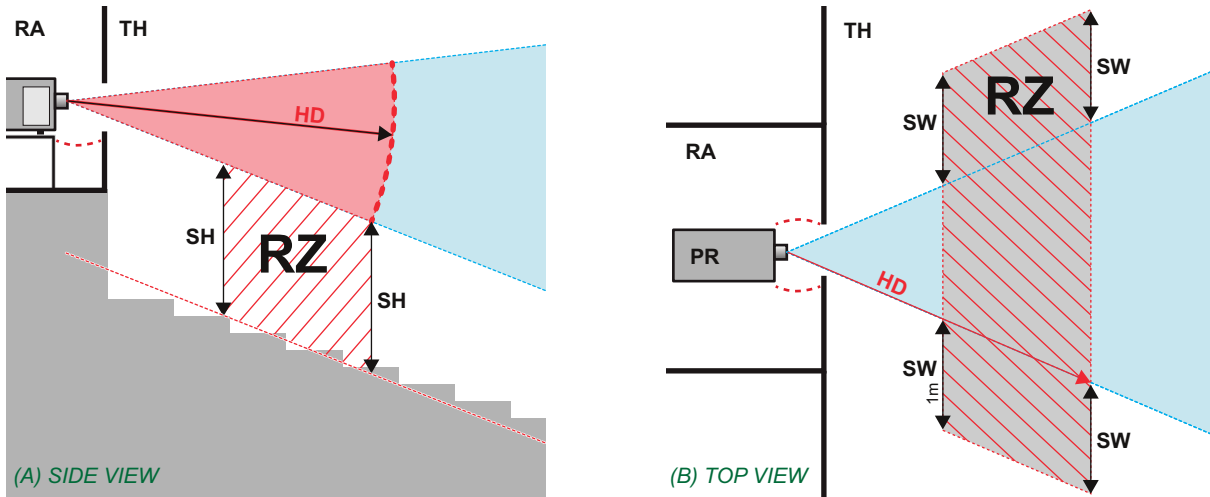

Image 2-1

- A** Side view.
- B** Top view.
- RA** Restricted Access location (boot area of projector).
- PR** Projector.

- TH** Theater.
- RZ** Restriction Zone in the theater.
- SH** Separation Height.
- SW** Separation Width.

Based on national requirements, no person is allowed to enter the projected beam within the zone between the projection lens and the related hazard distance (HD). This shall be physically impossible by creating sufficient separation height or by placing barriers. The minimum separation height takes into account the surface upon which persons other than operator, performers or employees are permitted to stand.

On Image 2-2 a typical setup is displayed. It must be verified if these minimum requirements are met. If required a restricted zone (RZ) in the theater must be established. This can be done by using physical barrier, like a red rope as illustrated in Image 2-2.

The restricted area sticker can be replaced by a sticker with only the symbol.

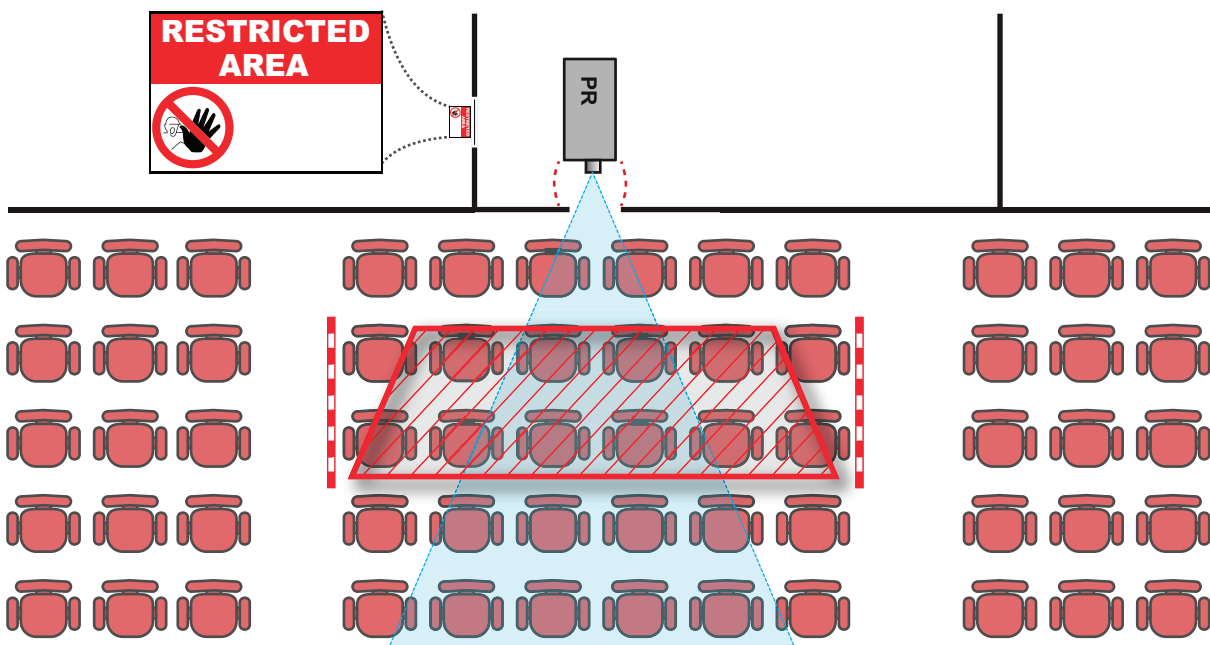

Image 2-2

USA market

For LIPs (Laser Illuminated Projectors) installed in the USA market other restriction zone conditions apply.

LIPs for installation in restrained environment (cinema theaters) shall be installed at height vertically above the floor such that the bottom plane of the hazard distance zone shall be no lower than 2.5 meters above the floor. Horizontal clearance to the hazard distance zone shall be not less than 1 meter.

LIPs for installations in unrestrained environment (large venues,..) shall be installed at a height vertically above the floor such that the bottom plane of the Hazard distance Zone shall be no lower than 3 meters above the floor. Horizontal clearance to the hazard distance zone shall be not less than 2.5 meters. Any human access horizontally to the Hazard Zone, if applicable, shall be restricted by barriers. If human access is possible in an unsupervised environment, the horizontal or vertical clearances shall be increased to prevent exposure to the hazard distance zone.

In addition for temporary installations (e.g.: rental and staging, lease, events ...) the following requirements apply:

- This product can only be installed by Barco or sold or leased only to valid laser light show variance holders. In other words our installers are required to have an approved laser light show variance. Such installers may currently hold a valid variance for production of Class IIIb and IV laser light shows and/or for incorporation of the RG3 LIPs into their shows. Dealers and distributors are also required to obtain a valid laser light show variance.
- This product shall be located in such a way that all propagating beam paths within the Restriction Zone, and the audience can be directly observed at all times.
- Effects other than front or rear screen projections shall not be performed.
- Communication shall be maintained with other personnel assisting in surveillance of the LIP projection.
- In the event of any unsafe condition, immediately terminates (or designate the termination) of LIP projection light.

Install one or more readily accessible controls to immediately terminate LIP projection light. The power input at the projector side is considered as a reliable disconnect device. When required to switch off the projector, disconnect the power cord at the projector side. In case the power input at the projector side is not accessible (e.g. truss mount), the socket outlet supplying the projector shall be installed nearby the projector and be easily accessible, or a readily accessible general disconnect device shall be incorporated in the fixed wiring.

Laser light shows can be requested via the FDA online eSubmitter portal or via FDA Form FDA Form 3147 referencing to Barco's variance approval 2016-V-0144.

The installation checklist for laser illuminated RG3 projectors must be fully completed after the installation and sent to pvg@barco.com. This checklist can be downloaded from the Barco website. Only when the installer is a valid laser light show variance holder the checklist should not be sent to Barco.

2.6 HD for fully enclosed projection systems

HD



Hazard Distance (HD) is the distance measured from the projection lens at which the intensity or the energy per surface unit becomes lower than the applicable exposure limit on the cornea or on the skin. The light beam is considered (to be) unsafe for exposure if the distance from a person to the light source is less than the HD.

Restriction Zone (RZ) based on the HD

The projector is also suitable for rear projection applications; projecting a beam onto a defuse coated projection screen. As displayed in Image 2-3 two areas should be considered: the restricted enclosed projection area (RA) and the observation area (TH).

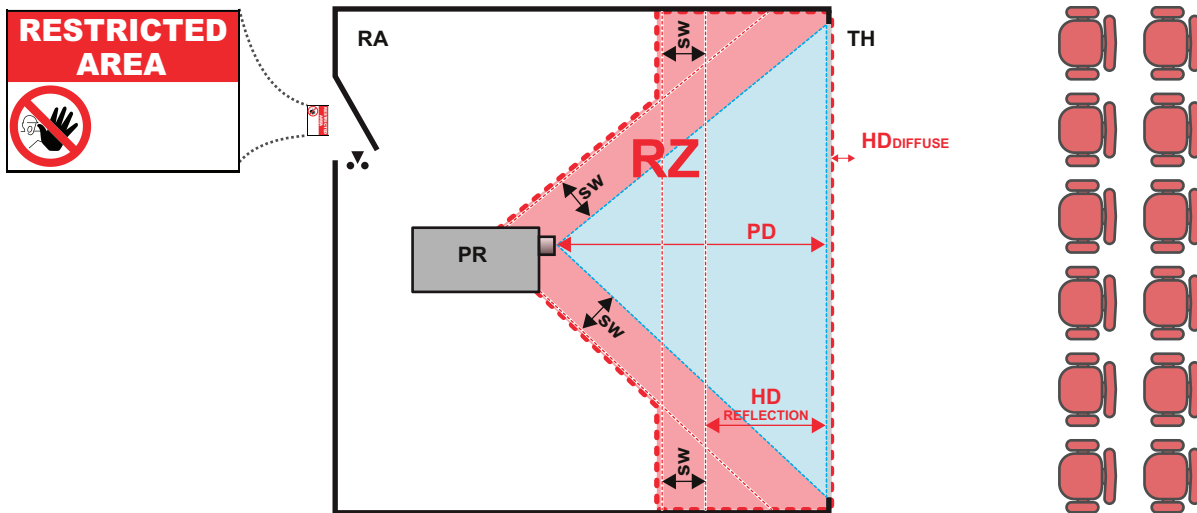

Image 2-3

- RA** Restricted Access location (enclosed projection area).
- PR** Projector.
- TH** Theater (observation area).
- RZ** Restriction Zone.
- PD** Projection Distance.
- SW** Separation Width. Must be minimum 1 meter.

For this type of setup 3 different HD shall be considered:

- HD as discussed in “High Brightness precautions: Hazard Distance (HD)”, page 16, relevant for intrabeam exposure.
- $HD_{\text{reflection}}$: the distance that has to be kept restrictive related to the reflected light from the rear projection screen.
- HD_{diffuse} : the relevant distance to be considered while observing the diffuse surface of the rear projection screen.

As described in “High Brightness precautions: Hazard Distance (HD)”, page 16, it is mandatory to create a restricted zone within the beam areas closer than any HD. In the enclosed projection area the combination of two restricted zones are relevant: The restricted zone of the projected beam toward the screen; taking into account 1 meter Separation Width (SW) from the beam onward. Combined with the restricted zone related to the rear reflection from the screen ($HD_{\text{reflection}}$); also taking into account a 1 meter lateral separation.

The $HD_{\text{reflection}}$ distance equals 25% of the difference between the determined HD distance and the projection distance to the rear projection screen. To determine the HD distance for the used lens and projector model see graphs in chapter “HD in function of modifying optics”, page 20.

$$HD_{\text{reflection}} = 25\% (HD - PD)$$

The light emitted from the screen within the observation shall never exceed the RG2 exposure limit, determined at 10 cm. The HD_{diffuse} can be neglected if the measured light at the screen surface is below 5000 cd/m² or 15000 LUX.

2.7 HD in function of modifying optics

Hazard Distance

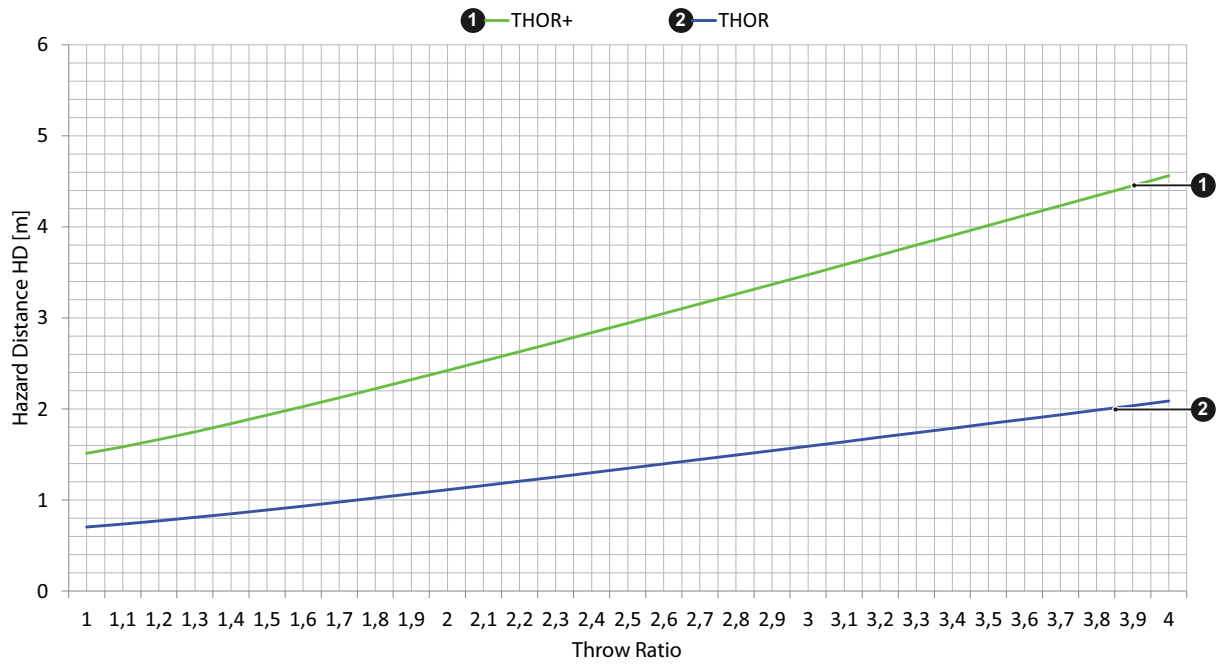

Image 2-4

Lenses & Lens selection

3

About this chapter

This chapter gives an overview of available lenses for your Thor and explains how to select the best suited lens for a specific situation using the lens calculator. Also, it is explained how to install and remove a lens from the projector Lens Holder and how to shift, zoom and focus the lens.



CAUTION: Never transport the projector with a Lens mounted in the Lens Holder. Always remove the Lens before transporting the projector. Neglecting this can damage the Lens Holder and Prism.



CAUTION: Caution when removing or installing the lens! Fragile parts at the inner side of the Lens Holder.



Each time a lens is manipulated (e.g. removed and installed in a projector), it needs to be homed and returned.

Overview

- Available lenses
- Lens selection
- Lens installation
- Lens removal
- Lens shift, zoom & focus

3.1 Available lenses

Which lenses are available for my projector?



The table below is subject to changes and was last updated on 22/12/2017. Consult Barco's web site for the most recent information about available lenses.

Order No	Type	Throw Range		Projector series				
		2K	4K	DP2K-B DP4K-B DP2K-BLP DP4K-BLP DP4K-L	DP4K-P Prometheus I Prometheus II	DP4K-LHC DP4K-BLPHC Thor Prometheus III		
R9856504	HB	1.25-1.90	1.13-1.72	X				
R9856506	HB	1.25-1.91	1.13-1.72	X				
R9856294	HB	1.49-2.05	1.35-1.86	X				
R9856297	HB	1.61-2.31	1.46-2.10	X				
R9856300	HB	1.82-2.86	1.65-2.60	X				
R9856303	HB	2.21-3.70	2.00-3.35	X				
R9855947	HB	2.8-5.5	2.53-4.98	X				
R98565042	HC		1.13-1.72	X	X			
R98562942	HC		1.35-1.86	X	X			
R98562972	HC		1.46-2.10	X	X			
R98563002	HC		1.65-2.60	X	X			
R98563032	HC		2.00-3.35	X	X			
R98565043	VHC		1.13-1.72					X
R98562943	VHC		1.35-1.86					X
R98562973	VHC		1.46-2.10					X
R98563003	VHC		1.65-2.60					X
R98563033	VHC		2.00-3.35					X

3.2 Lens selection

Which lens do I need?

1. Go to Barco's website on www.barco.com and click on myBarco

2. Login on.

If you are not yet registered create a login and password. With the created login and password, it is possible to enter myBarco.

When your login is correct, the start page is displayed.

3. Click the **Support** tab, then **Digital cinema calculator** (on the left of the screen) and select the appropriate lens calculator.

The lens calculator (see screenshot, Image 3-1) will be displayed.

The lens calculator allows you to have an overview of which lenses are suitable for your specific projector setup. Just make your selection of parameters and all possible configurations are displayed.

Image 3-1: Digital cinema lens calculator



Take into account that when the projector is **tilted** the **Screen Width** you have to fill in should be **larger** than the physical screen width due to the keystone distortion of the projected image. How much larger depends on the amount of tilt.



Due to production tolerances the real distances can differ by 2% from the calculated values. For critical situations (fixed installs that use the lens at one of its extreme zoom positions) this should be taken into account.

3.3 Lens installation



If no lens is installed the lasers of the Thor series projector can not be powered. The Standby button or Light button will light up red. The Projector Toolset will also show the error message that there is no lens installed.

How to install a lens into the Lens Holder?

1. Remove the plastic cover in the opening of the Lens Holder if not removed yet. Place the Lens Holder in the “**unlocked**” position by moving the lens lock handle (reference 1 Image 3-2) to the right. Then, take away the plastic cover.

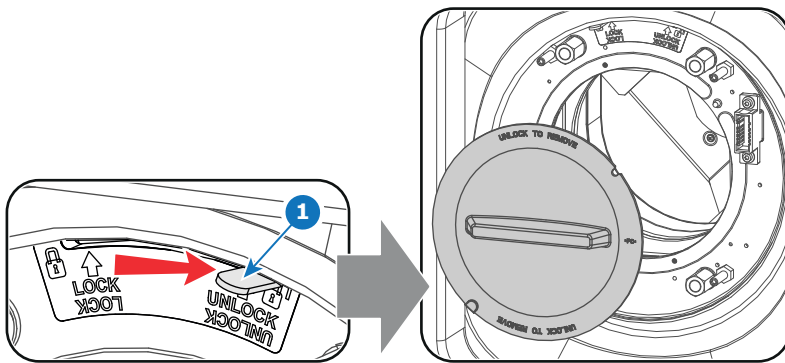

Image 3-2

2. Take the lens assembly out of its packing material and remove the lens caps on both sides.

! **Caution:** Do not touch the glass of the lens!

3. Ensure that the Lens Holder stands in the On-Axis position (horizontal and vertical mid position). As best as possible.
4. Place the Lens Holder in the “locked” position by moving the lens lock handle (reference 1 Image 3-3) to the left, away from the lens power supply socket (reference 2 Image 3-3).
5. Gently insert the lens in such a way that the lens connector matches the socket. To prevent collision of the lens ensure you centre the lens and keep it on-axis while approaching.

! **Warning:** Do not release the Lens yet, as the Lens may fall out of the Lens Holder.

6. **Push** the lens completely against the Lens Holder front plate. An **audible click** should be noticed. Once seated, there may be no airgap between lens flange and Lens Holder front plate.

! **Caution:** Ensure that the lock handle remains in the “locked” position.

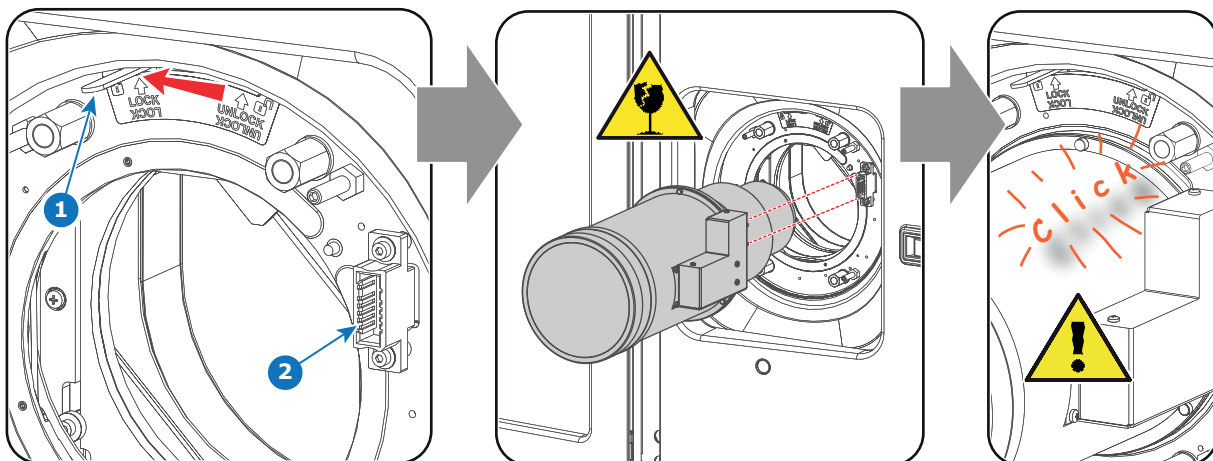

Image 3-3

Note: For frequent installation and removal of the lens it is recommended to install the lens while the lock handle is in “open” position (to the right) and put the lock handle in “locked” position once the lens is inserted. Then check if the lens is properly installed by trying to pull the lens out of the Lens Holder. (this alternative procedure result in less wear of the Lens Holder and avoids the risk of moving and misaligning the projector while pushing the lens inwards).

7. Check if the lens is really secured by trying to pull the lens out of the Lens Holder.
8. Activate the corresponding lens parameters for the installed lens. (See user guide of the “Projector Toolset” chapter *Installation > Advanced > Lens parameters*)

! **Caution:** Not using the correct lens parameters could result in lens damage.

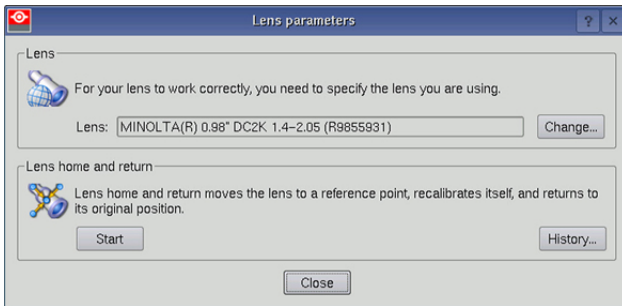

Image 3-4

9. Perform a lens **HOME & RETURN** operation. (See user guide of the “Communicator” chapter *Installation > Advanced > Lens parameters*)

Note: The HOME & RETURN operation enables the projector to determine the reference positions of the motorized ZOOM and FOCUS barrels of the installed lens.



A Spatial Color Calibration (SCC) has to be executed in case of a first install or in case a High Brightness lens is swapped with a High Contrast lens or vice versa. See user guide of the Communicator for detail SCC calibration instructions.



CAUTION: Never transport the projector with a Lens mounted in the Lens Holder. Always remove the Lens before transporting the projector. Neglecting this can damage the Lens Holder and Prism.

3.4 Lens removal

How to remove a lens from the Lens Holder?

1. Support the lens with one hand while you unlock the lens holder by sliding the lock handle (reference 1 Image 3-5) towards the “unlocked” position as illustrated.
2. Gently pull the lens out of the lens holder, maintaining its coaxial direction.

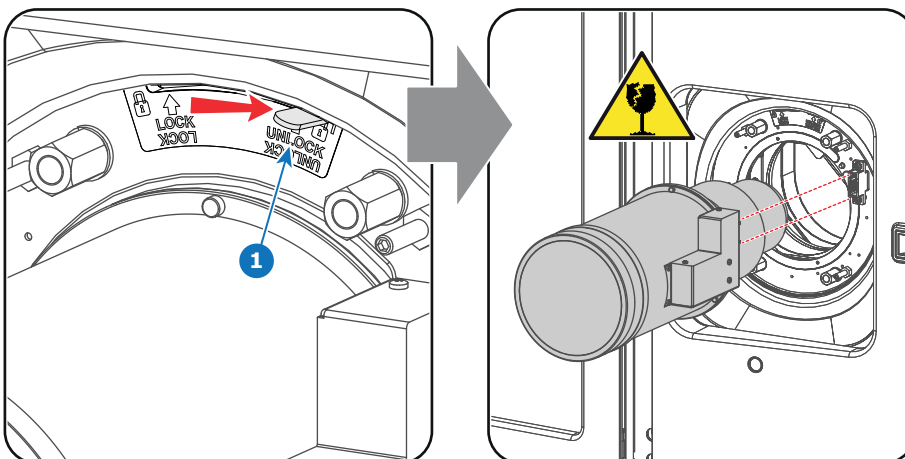

Image 3-5



It's recommended to place the Lens caps of the original Lens packaging, back on both sides of the removed Lens to protect the optics of the Lens.



It's recommended to place the plastic cover of the original projector packaging, back into the lens opening to prevent intrusion of dust. This plastic cover prevents that dust is entering the projector.



If no lens is installed the lasers of the Thor series projector can not be powered. The Standby button en Light button will light up red. The Projector Toolset will also show the error message that there is no lens installed.

3.5 Lens shift, zoom & focus

Motorized lens adjustment

The Thor is equipped with a motorized lens shift and zoom & focus functionality.

Maximum shift range

The lens can be shifted with respect to the internal optics of the projector (DMD) which results in a shifted image on the screen (Off-Axis). A 100% shift means that the centre point of the projected image is shifted by half the screen size. In other words, the centre point of the projected image falls together with the outline of the image in an On-Axis projection. Due to mechanical and optical limitations the shift range is limited as well.

All DC4K lenses have a shift range of 50% up, 50% down, 17% left, and 17% right. This range is valid for all throw ratios. Within these shift ranges the projector and lens perform excellently. Configuring the projector outside these shift ranges will result in a slight decline of image quality.

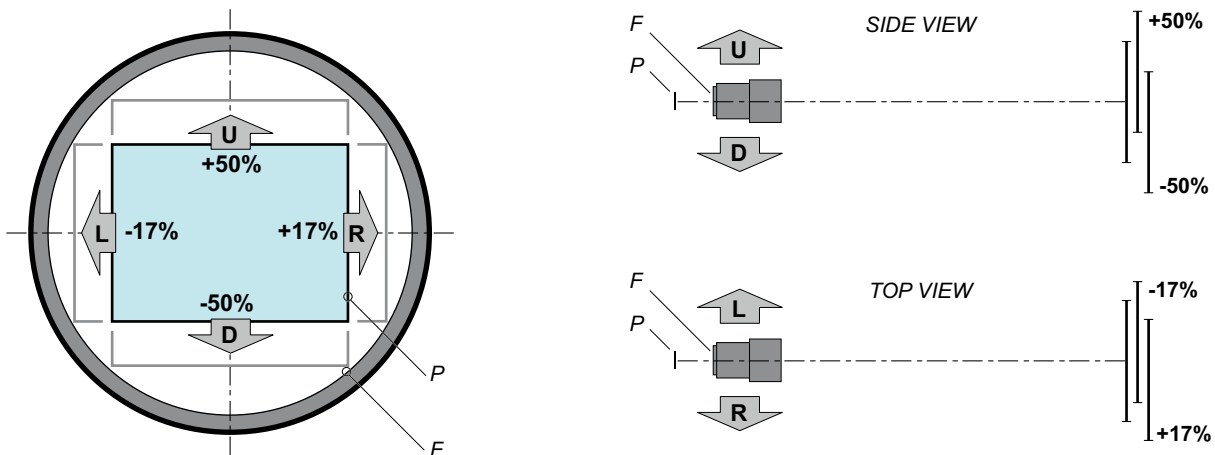

Image 3-6

- P** DMD.
- F** Field of view.



It's mechanical possible to shift outside the recommended field of view, but this will result in a decline of image quality depending on the used lens and the zoom position of the used lens. Furthermore, shifting too much in both directions will result in a blurred image corner.

How to shift the lens of the Thor ?

1. Use the **up and down** arrow buttons on the Local Keypad to shift the lens **vertically** and use the **left and right** arrow buttons on the Local Keypad to shift the lens **horizontally**.

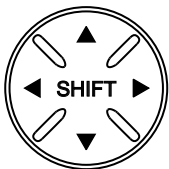

Image 3-7

How to zoom in or out?

1. Use the **“+” and “-” zoom buttons** on the Local Keypad to zoom in or out.

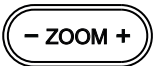

Image 3-8

How to focus?

1. Use the “+” and “-” **focus buttons** on the Local Keypad to focus the image on the screen.



Image 3-9



Take into account that the lens focus may slightly drift while the lens is warming up from cold to operation temperature. This is a typical phenomenon for projection lenses used with high brightness projectors. The operation temperature of the lens is reached after approximately 30 minutes projection of average video.

Button backlight colors

- **WHITE** : The default backlight color of the Shift, Zoom and Focus buttons is white which indicates that the button is enabled.
- **PURPLE** : When pushing the Shift, Zoom or Focus button the backlight color is purple of the part of the button that is pushed. This indicates that the requested action is ongoing.
- **RED** : The backlight color of the Shift, Zoom and Focus buttons is red in case of end of range.

Input & Communication

4

About this chapter

This chapter describes the functionality of the Local Keypad, the projector Status Light (tail light) and the different input and communication ports of your Thor.

Note that all information about the ICMP is gathered into one separated chapter: "ICMP", page 37.

Overview

- Introduction
- Projector Status
- Laser Status
- Local Keypad
- Cinema Controller

4.1 Introduction

General

The Input & Communication side of the Thor consists of a Local Keypad integrated into the projector housing and a card cage with three slots. The rear side of the projector is equipped with a tail light which reflects the status of the projector. The laser status light is located on the top side of the projector.

The projector card cage is equipped with an ICMP. See illustration below. Note that all information about the ICMP is gathered into one separated chapter: "ICMP", page 37.

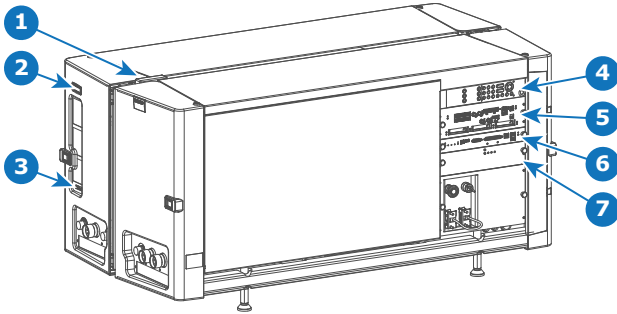

Image 4-1

- | | |
|--|---|
| <ul style="list-style-type: none"> 1 Laser status light. 2 Projector status light. 3 Communication port with Chillers. 4 Local keypad. | <ul style="list-style-type: none"> 5 ICMP. 6 Barco Cinema Controller. 7 Switch Mode Power Supply (SMPS) for projector electronics (not lasers) |
|--|---|



CAUTION: A unit may only be removed from the card cage by qualified service personnel. Removing one of the boards (except for the Cinema Controller or SMPS) will result in an authorization request upon starting.

4.2 Projector Status

About the projector Status Light

The projector Status Light is located at the rear side of the projector (reference 1 Image 4-2). The projector Status Light is a real time indicator of the projector condition.

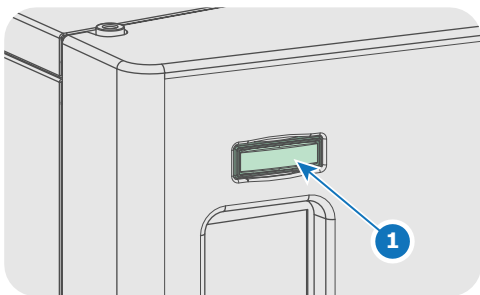

Image 4-2

Status overview

Depending on the condition of the projector the status light may have 4 colors: Green, Yellow, Red or Blue. Each color represent a different state:

Blinking Green

Projector is booting up.

Green

Projector is running normally.

Yellow

Projector is running with warnings. Event can go on but a technical intervention might be needed in the future to prevent a complete stop of the projector.

Red

Projector is in error state. Problem could prevent normal operation. Solve the problem before the projector.

Blue

Projector runs in notification state. Maintenance action required.

Operational mode

In Operational mode the lasers of the projector are switched OFF but all the electronics of the projector remain fully operational. The projector is ready to activate the lasers and project the image. The status light is not different between Operational mode and Light ON mode.

Standby mode

If the projector is in **Standby** mode then the **status light flashes** every ten seconds. The color of the flash depends on the state of the projector. In other words, the color of the flash will be green in normal state (no warnings, no errors, no notifications).

In Standby mode the total power consumption of the projector is less than 15W. All electronics are switched off (including PSUs for the lasers) except for Cinema Controller board and Local Keypad. Only the following functionalities of the projector remains active:

- Local Keypad
- Router LAN and WAN port fully functional
- USB IN port type "B" (Virtual comport RS232)
- USB OUT port type "A" (To power handheld devices [500mA MAX]. No other functionality supported)
- GPIO port on the Cinema Controller

Pressing the Standby button in Operational mode for 3 seconds puts the projector in Standby mode. After de-conditioning then the projector goes in Standby mode.

Pressing the Standby button in Standby mode for 3 seconds will awake the projector towards operational mode. The status light will blink for a few seconds (booting up all inactive boards) and then lights up continuously.

Enter or leave Standby mode can also be done via two dedicated projector commands (USB/Ethernet), or via two predefined Macros (not editable) with GPIO of the Cinema Controller (not the GPIO of the ICMP), or via the Communicator.



The projector always boots up in the same mode (E.g. Standby or Operational) as it was powered OFF.

4.3 Laser Status

About the Laser Status Light

The Laser Status Light is located at the rear top of the projector (reference 2 Image 4-3). The Laser Status Light is a real time indicator of the laser condition.

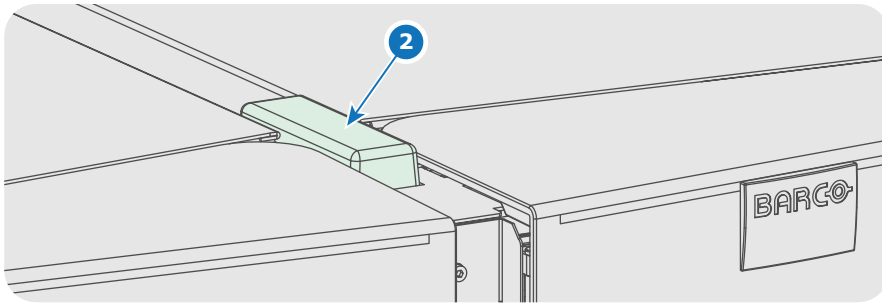

Image 4-3

Status overview

The Laser Status light has only one color: white. The combination of the Laser Status light and the backlight of the Power On/Off button on the Local Keypad indicates a certain condition of the projector. See table below.

Status Light	Light Button	Meaning
Off	Continuous white or off	Sealed compartments are DECONDITIONED. Lasers are not active (service personnel to open the compartments).
Blinking (6 seconds)	Blinking green	Indicates the start of the CONDITIONING process. After six seconds the light will light up continuously.
On	Blinking green	Ongoing CONDITIONING process. Lasers are tested
	Continuous green	Sealed compartments are fully CONDITIONED. Lasers are active and ready for projection.
	Blinking white	Ongoing DECONDITIONING process. Lasers can be active
Slow blinking	Continuous white or red	Not safe to open the sealed compartments due to risk of condensation. The dew point of the boot area is too high. Wait until the status light turns off and remains off.

4.4 Local Keypad

Identification of the buttons

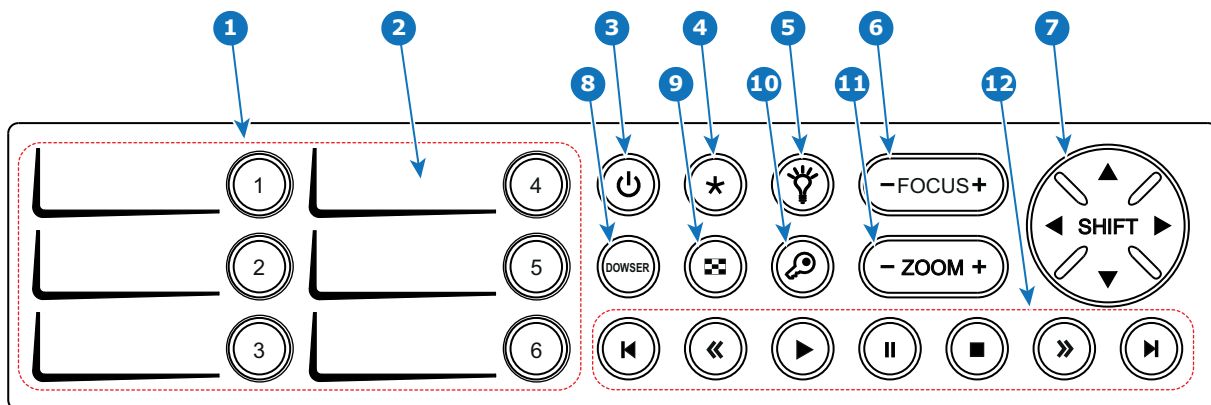

Image 4-4

Functionality of the buttons

1 Numeric buttons (No.1 - 6)

Each Numeric button (reference **1** Image 4-4) can be linked to a macro which allows you to setup the projector to your requirements with one push of a button. The backlight of the Numeric button is white if a macro is associated with the Numeric button. The backlight is green if the macro associated with the Numeric button is activated. The backlight is red in case one of the actions of the macro failed. Inactive Numeric buttons have no backlight.

When the authorization process is activated with the (security) Key button, the backlight of the Numeric buttons changes to yellow.

2 Marker area

Each Numeric button has a marker area (reference **2** Image 4-4) where you can write down the name of the Macro.

3 Standby button

Pushing the Standby button (reference **3** Image 4-4) for 3 seconds changes the projector mode from Standby mode (energy saving) to Operational mode or vice versa. The backlight of the Standby button is blinking white or green, depending on the requested mode. Once the requested mode is reached the backlight will be continuously lit up green in Operational mode or white in Standby mode.

Enter or leave Standby mode can also be done via a 2 dedicated projector command (USB/Ethernet), or via two predefined Macros (not editable) with GPIO, or via the Communicator.

During projector initialization the backlight of the Standby button is blinking blue.

In case the Light button and the Standby button continuous lights up red indicates that no lens is installed or that the ambient temperature inside the Light Processor compartment is exceeded or that the DMD FRONT or DMD BACK temperature is exceeded.

4 Star button

Star button (reference **4** Image 4-4). Pressing the Star button a few seconds will activate the ICMP reset process.

5 Light button

Light button (reference **5** Image 4-4) switches the lasers ON or OFF.

Pushing the Light button (reference **5** Image 4-4) for 3 seconds will activate or deactivate the lasers of the projector. The backlight of the Light button is blinking white or green, depending on the requested mode. Once the requested mode is reached the backlight will be continuously lit up green when the lasers are activated or white when the lasers are deactivated.

In case the Light button and the Standby button continuous lights up red indicates that no lens is installed or that the ambient temperature inside the Light Processor compartment is exceeded or that the DMD FRONT or DMD BACK temperature is exceeded.

6 Focus button

The Focus button (reference **6** Image 4-4) allows you to focus the projected image on the screen. The backlight of the Focus button is red in case the end of range is reached.

In case no lens (file) is selected the Focus button remains inactive. No backlight.

7 Shift button

The Shift button (reference **7** Image 4-4) allows you to shift the lens up/down or left/right. The backlight of the Shift button is red in case the end of range is reached.

In case no lens (file) is selected the Shift button remains inactive. No backlight.

8 Dowser button

The Dowser button (reference **8** Image 4-4) opens or closes the dowser. The backlight of the Dowser button is green when the dowser is requested to open and white when the dowser is closed. Red indicates an error.

9 Test Pattern button

The Test Pattern button (reference **9** Image 4-4) gives direct access to a limited set of the internal test patterns of the projector. This is a toggle button. To exit the Test Pattern mode toggle through all test patterns. Note that the convergence test pattern is not included in this set. The backlight of the Test Pattern button is blinking green if one of the test patterns is activated and lit up continuous green if none is activated. In case of failure the button lights up in red.

10 Key button

The (security) Key button (reference **10** Image 4-4) is used for the authorization procedure to clear tamper errors etc. Pin codes can be added/changed with the Communicator. The backlight of the Key button is normally green. If the DCI security is tampered then the backlight of the Key button is red.

11 Zoom button

The Zoom button (reference **11** Image 4-4) allows you to zoom in or out the projected image on the screen. The backlight of the Zoom button is red in case the end of range is reached.

In case no lens (file) is selected the Zoom button remains inactive. No backlight.

12 Media control buttons

Buttons (reference **12** Image 4-4) allowing you to navigate through the content on the integrated media server. (this feature is not yet implemented in the software, future expansion).

4.5 Cinema Controller

Location of the communication ports

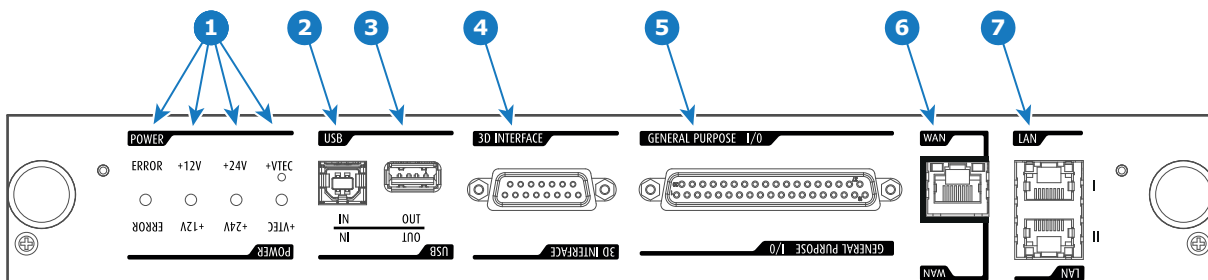

Image 4-5

Functionality

1 Diagnostic LEDs

The front plate of the Cinema Controller contains 4 diagnostic LEDs to display the status of the power supply (reference **1** Image 4-5):

- +VTEC supply.
- +24V supply.
- +12V supply.
- general power supply (ERROR).

2 USB IN port

The Cinema Controller is equipped with a USB port, type “B” connector, (reference **2** Image 4-5) to connect upstream devices (E.g. PC). This USB port is used to communicate with the projector via RS232 commands (Virtual comport). The USB IN port remains operational in Standby mode.

3 USB OUT port

The Cinema Controller is equipped with a USB port, type "A" connector, (reference 3 Image 4-5) which can be used to power handheld devices within USB spec (MAX 500mA/5V). No other functionality supported (Future expansion). The USB OUT port remains operational in Standby mode.

4 3D INTERFACE

3D interface port (reference 4 Image 4-5). Can be used to connect external 3D devices to the projector. All signals necessary for 3D projection can be provided via this connector. The 3D interface port is disabled if the projector is in Standby mode.

5 GENERAL PURPOSE INPUT/OUTPUT (GPIO)

This 37 pin connector (reference 5 Image 4-5) can be used to send or receive trigger signals from other devices. These input/output pins can be programmed by macros created with the Communicator software. See user's guide of the Communicator, section Macro editor, for more information about this functionality. Note that the General Purpose Inputs accept 24 volt maximum. The GPIO remains operational when the projector is in Standby mode. So, if the factory predefined macro to wake up the projector is assigned to one of the free GPI input pins the projector can be awakened via GPIO. Enter or leave Standby mode can also be done with GPIO via two predefined Macros (not editable).

6 Wide Area Network (WAN)

Wide Area Network (WAN: 10/100/1000 base-T). Use this Ethernet port (reference 6 Image 4-5) to connect the network which contains the DHCP server.

The Thor can be connected to a WAN (Wide area network) (reference 6 Image 4-5). Once connected to the WAN, users can access the projector from any location, inside or outside (if allowed) their company network using the Communicator software. This software locates the projector on the network if there is a DHCP server or the user can insert the correct IP-address to access the projector. Once accessed, it is possible to check and manipulate all the projector settings. Remote diagnostics, control and monitoring of the projector can then become a daily and very simple operation. The network connectivity allows detection of potential errors and consequently improves service time.

7 Local Area Network (LAN: 10/100/1000 base-T)

Local Area Network (LAN: 10/100/1000 base-T) with built-in Ethernet switch (port 1 and port 2). Use for projector control and automation. E.g. Touch Panel, content server, ... (not for content streaming!)

As there is a need to daisy chain projectors when they are on an Ethernet network, an Ethernet switch is built in. the incoming network is hereby available for the internal PC and for the next device in the chain. In this way a 'star' network interconnection can be avoided. The switch used is a stand alone 10/100/1000Mbit Ethernet switch. This assures no influence on the network speed. Furthermore, this Ethernet switch remains operational when the projector is in Standby mode.

The connectors used for these Ethernet ports are of the type RJ45, which is compatible with standard RJ45 cable connector. Straight (most common) as well as cross linked network cables can be used. The 2 ports are functionally identical. Both ports are connected via the projector switch (Auto sensing enabled).

Cinema Controller functions:

- Ethernet Communication to ICMP.
- Virtual COM port (RS232) to BARCO Controller on the USB-IN port.
- Standardized 3D interface on board.
- GPIO controls
- Lensholder motors (stepper motors)
- Stores lens files and lens type / Controls lens
- Lens motor drivers (DC motors)
- Controls lamp power supply
- Stores SNMP key
- Stores Barco IP address and host name
- Handles reporting of errors, version info & Barco logs to Communicator

- Controls and monitors keypad (Button module)
- Controls and monitors status lights
- Stores Macro files, Input files, Lens files, 3D files and Light Sensor Calibration file (LSC)

Virtual comport (RS232 serial communication)

The USB-IN port of the communication interface supports RS232 serial communication. You can use the RS232 input port to connect a local PC to your Thor projector. This way you can configure and control your Thor projector from your local PC via RS232 (serial) communication protocol.



Do not forget to set the projector's baud rate (default = 115200) to match that of the computer.

Advantages of using RS232 serial communication:

- easy adjustment of the projector via PC (or MAC).
- wide range of control possibilities.
- copying data from the projector (backup).

RS232



An Electronic Industries Association (EIA) serial digital interface standard specifying the characteristics of the communication path between two devices using either D-SUB 9 pins or D-SUB 25 pins connectors. This standard is used for relatively short-range communications and does not specify balanced control lines. RS-232 is a serial control standard with a set number of conductors, data rate, word length and type of connector to be used. The standard specifies component connection standards with regard to computer interface. It is also called RS-232-C, which is the third version of the RS-232 standard, and is functionally identical to the CCITT V.24 standard. Logical '0' is $> +3V$, Logical '1' is $< -3V$. The range between $-3V$ and $+3V$ is the transition zone.

About this chapter

This chapter describes the ICMP in general, the HDDs, the input ports and the communication ports. Furthermore, the status LEDs are described and the importance of the device certificate is illustrated.



Image 5-1

Overview

- ICMP introduction
- ICMP HDD
- ICMP communication ports
- ICMP source input ports
- ICMP DisplayPort specifications
- ICMP SDI specifications
- ICMP HDMI 2.0 specifications
- ICMP HDMI 1.4 specifications
- ICMP status LEDs
- ICMP HDD status LEDs
- ICMP device certificate
- ICMP configuration via Communicator
- ICMP reset
- Obtaining the Barco ICMP certificate
- Removing a HDD from the ICMP

- Installing a HDD into the ICMP

5.1 ICMP introduction

About ICMP

The ICMP is a removable electronic assembly situated in the Card Cage of the projector. The ICMP stores, decrypts and decodes DCI cinema content and delivers it to the projector in a usable format, all integrated into a single assembly placed directly in the projector. ICMP is a fully integrated assembly so expected by the operators to facilitate their daily business.

The standard Integrated Cinema Processor functionality from Texas Instruments® is fully integrated into the ICMP. So, the ICMP replaces the ICP board as well.

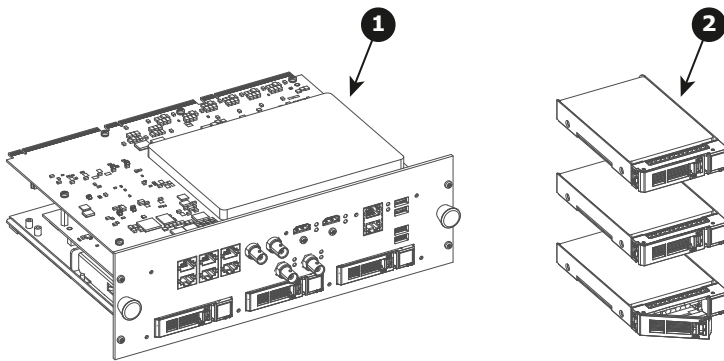

Image 5-2

- 1 ICMP
- 2 HDDs for ICMP

As an integrated component of the projector, installation and maintenance of the ICMP requires the same skills and the same precautions as an intervention on the projector itself.

For order info see www.barco.com.

Front face of the ICMP

The last produced model is equipped with two HDMI 2.0 as video source.

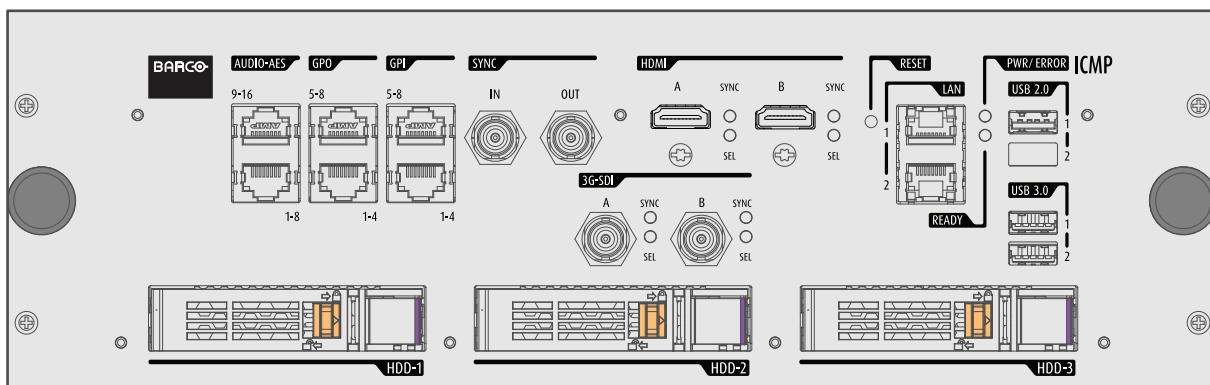

Image 5-3: Front face ICMP (with HDMI 2.0).

Some models with DisplayPorts and one HDMI 1.4 (mezzanine) are still present on the field.

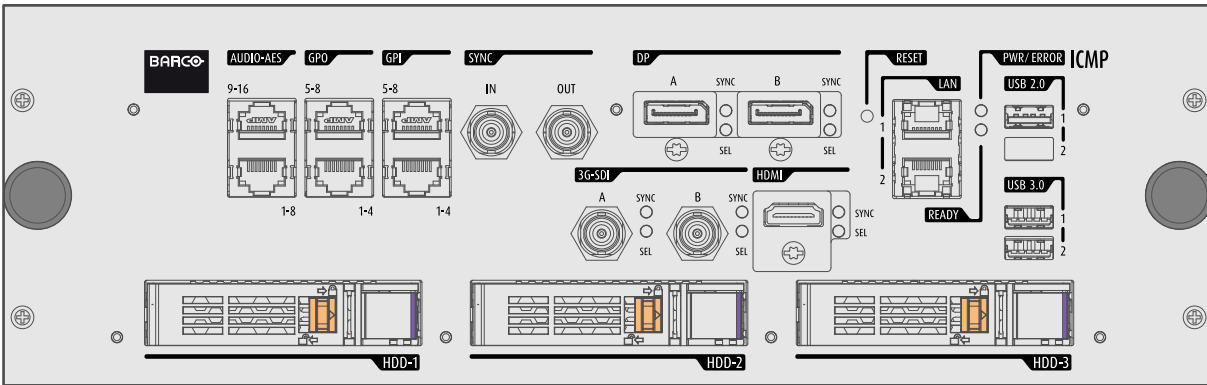

Image 5-4: Front face ICMP (with DisplayPort and HDMI 1.4).

Card Cage slot location

The Card Cage can be different depending the projector type but it always consists of a button module and several removable units. The ICMP (reference 1) is inserted into the former ICP slot and IMB slot above the Barco Cinema Controller (reference 2).

ICMP location in the Card Cage of a L-series projector.

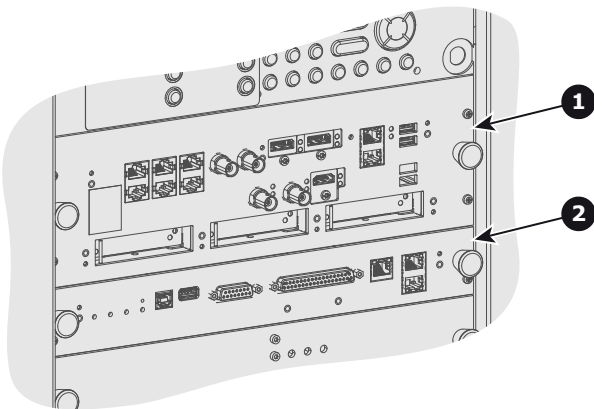

Image 5-5

5.2 ICMP HDD

About ICMP HDD

The three HDDs (local storage) in the ICMP, are set up in a RAID 5 configuration. This storage technique, that combines multiple HDD components into a logical unit, manages enough redundancy information to continue to operate properly after the loss of one HDD.

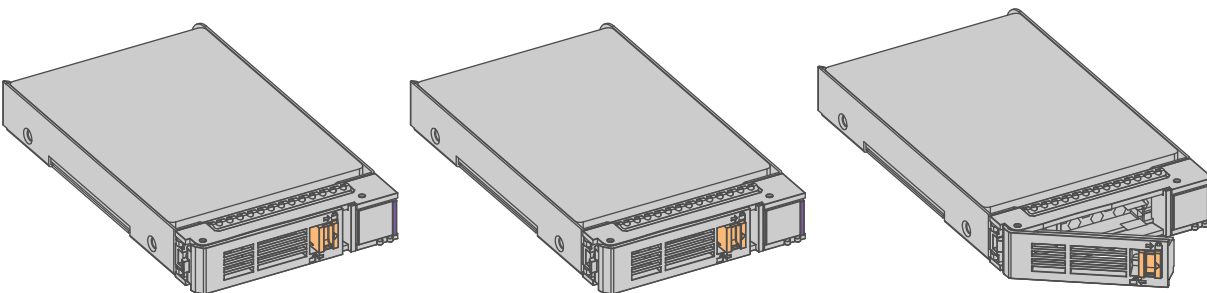

Image 5-6

CAUTION: A RAID 5 configuration with three HDDs allows a maximum loss of one disk. With the simultaneous loss of more than one HDDs, data is lost and the RAID must be completely initialized again after replacement of the defect HDDs with new HDDs!

About degraded mode

When a RAID array experiences the failure of one disk, it enters in degraded mode. Content storage and playback remains available on the ICMP.



CAUTION: The loss of one disk causes no serious consequences on the ICMP. But action must be taken quickly because the loss of a second disk will make the RAID system broken. The main cause of the total loss of RAID is due in most cases to the loss of the second disk while the first has not been rebuilt!



A failed drive should be replaced as soon as possible.

About “RAID recovery” process

The restoration from degraded to normal condition of the RAID 5 system is done automatically. When the RAID controller detects a new HDD to replace the failed disk the recovery procedure starts automatically.



CAUTION: The automatic process does not work if more than one disk is lost. In that case the RAID must be completely initialized again!

About RAID broken

When more than one HDD is out of order, the RAID is considered as 'broken' and the content is lost. The failed HDDs must be changed and a new RAID must be created.

Exchange or re-use of a disk set

It's possible to have several sets of disks with one ICMP or to reuse a complete set of disks coming from another projector with ICMP. It is sufficient to insert the three HDDs, from a valid RAID array, and let the system explore the new RAID. The mounting order of the HDDs and the HDD slots do not matter. Of course, when using HDDs from another ICMP it is necessary to retrieve from the content distributor the KDMs corresponding to the content and the new ICMP.

HDD storage capacity

Make sure that all HDDs in the ICMP HDD set have the same storage capacity. See label on top of the HDD to know the storage capacity.

HDD storage

The maximum recommended storage period for the drive in a non-operational environment is 90 days. Drives should be stored in the original unopened shipping packaging whenever possible. Once the drive is removed from the original packaging the recommended maximum period between drive operation cycles is 30 days. During any storage period the drive non-operational temperature, humidity, wet bulb, atmospheric conditions, shock, vibration, magnetic and electrical field specifications should be followed.

HDD models validated by Barco

Only the original HDD spare parts provided by Barco or models validated by Barco (see list below) can be used in the ICMP. All deviations from this rule void warranty.

List of validated models:

- 1TB: HGST – Western Digital (order code: HCC541010A9E630)
- 2TB: Seagate (order code : ST2000NX0253)

5.3 ICMP communication ports

Location of the communication ports

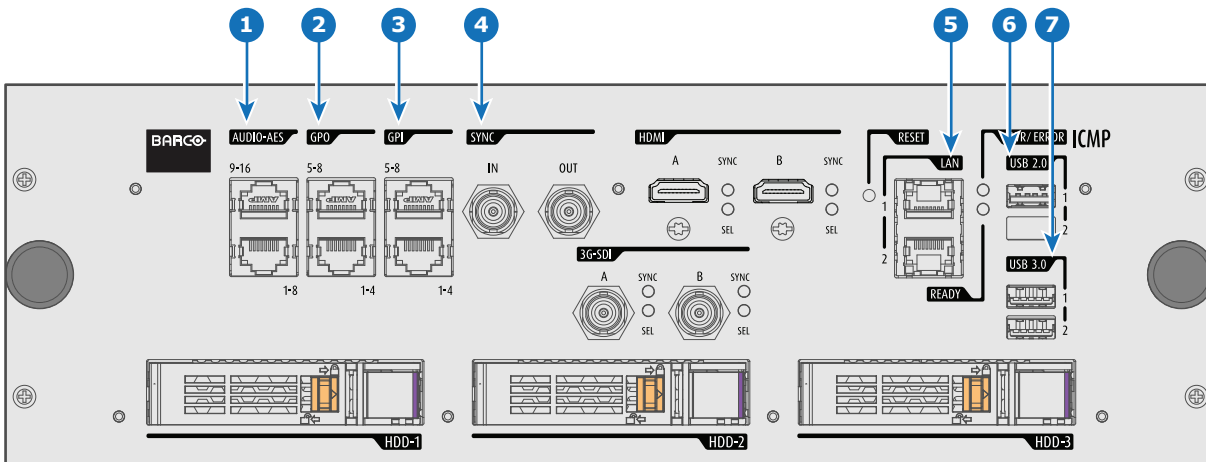

Image 5-7: ICMP (with HDMI 2.0).

Functionality

1 AUDIO-AES 1-8 (9-16)

ICMP outputs sixteen audio signals equitably distributed over these two RJ45 connectors, which can be configured independently. The mapping of audio channels (content) on each audio output (AES outputs of the ICMP) is performed by configuring the ICMP via the Communicator software. Please refer to the Communicator user guide for further information.

2 GPO 1-4 (5-8)

These RJ45 connectors can be used to send trigger signals to other devices. The mapping of user Cues (output Cues) on each General Purpose Output (GPO) is configured via the Communicator software. Please refer to the Communicator user guide for further information.

3 GPI 1-4 (5-8)

These RJ45 connectors can be used to receive trigger signals from other devices. The mapping of the General Purpose Input (GPI) on each input Cues is configured via the Communicator software. Please refer to the Communicator user guide for further information.

4 SYNC IN / OUT

Synchronization signal IN and OUT: Reserved for multiple-projector projection. Use a 50 Ohm coaxial cable to connect the sync signal from projector to projector.

5 LAN 1 (2)

The ICMP can be connected to a LAN (local area network) using one of the Ethernet ports. These LAN port are used for 'content' transfer.

NOTE: These ports are optionally used to connect to external content storage sources. Control of the ICMP is done via the same IP address as the projector.

6 USB 2.0

The ICMP can be connected to a USB 2.0 Media to load content. The USB port can be used to load content (DCP) or keys (KDM).

NOTE: It is recommended to use the USB 3.0 ports for faster ingest.

7 USB 3.0

The ICMP can be connected to a USB 3.0 Media to load content. The USB port can be used to load content (DCP), or keys (KDM), or software update.

NOTE: These ports are recommended for fast ingest when connected to an appropriate USB 3.0 source.

USB



Universal Serial Bus (USB) is an industry standard developed in the mid-1990s that defines the cables, connectors and communications protocols used in a bus for connection, communication, and power supply between computers and electronic devices. **USB 2.0** (also called "Hi-Speed"), adding higher maximum signaling rate of 480 Mbit/s (effective throughput up to 35 MB/s or 280 Mbit/s), in addition to the "USB 1.x Full Speed" signaling rate of 12 Mbit/s.[16] USB 2.0 connectors are usually colored black. **USB 3.0** defines a new SuperSpeed mode with a signaling speed of 5 Gbit/s and a usable data rate of up to 4 Gbit/s (500 MB/s). A USB 3.0 port is usually colored blue, and is backwards compatible with USB 2.0.

5.4 ICMP source input ports

Location of the source input ports

The last produced model is equipped with two HDMI 2.0 (Reference 8, Image 5-8) as video source.

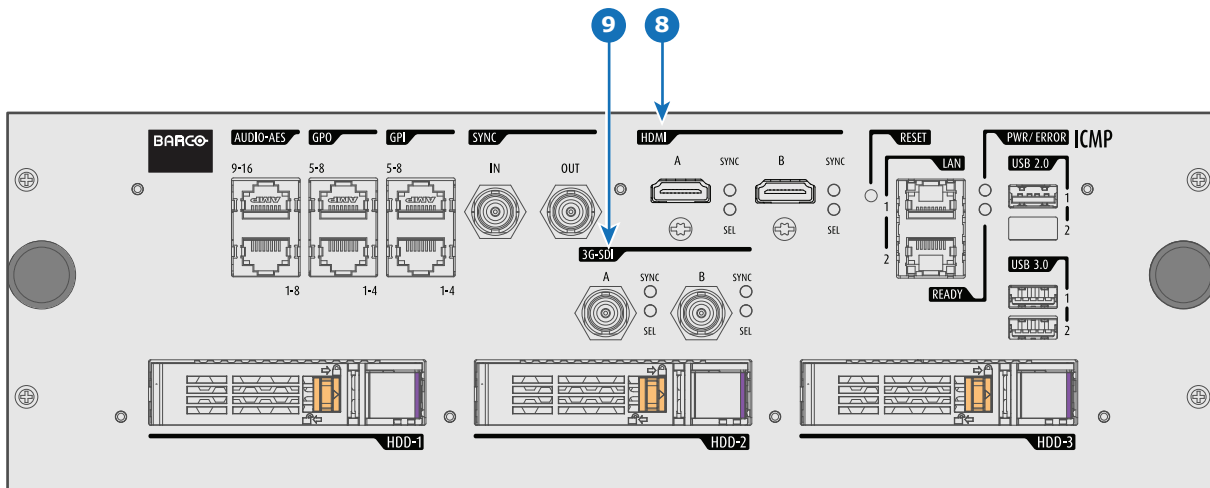

Image 5-8: ICMP (with HDMI 2.0).

Some models with DisplayPorts (Reference 11, Image 5-9) and HDMI 1.4 (Reference 10, Image 5-9) are still present on the field.

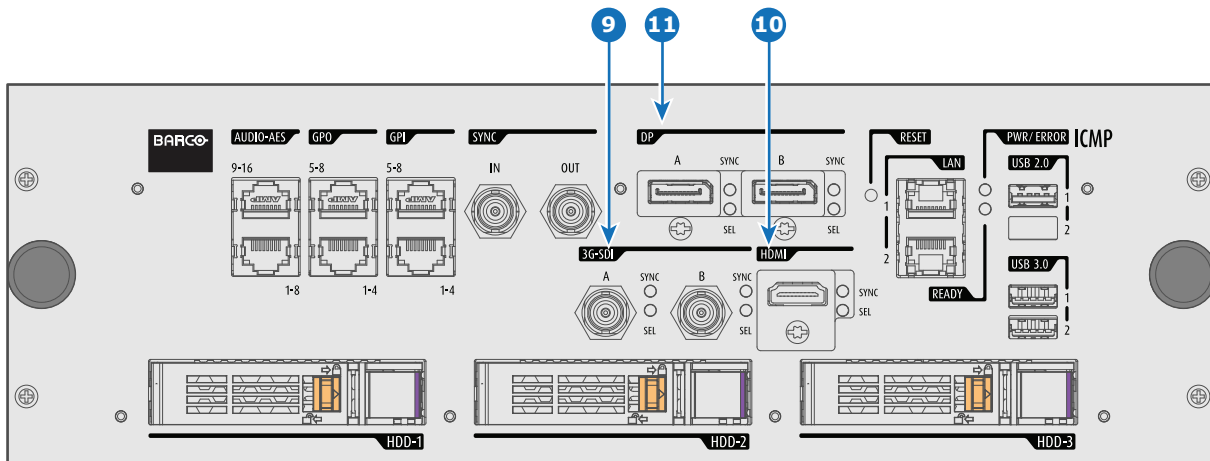

Image 5-9: ICMP (with DisplayPort and HDMI 1.4).

Functionality

8 HDMI A (B)

HDMI 2.0 connector to connect a video source.

NOTE: It is recommended to use the HDMI 2.0 ports for faster transfer of video and audio data.

9 3G-SDI A (B)

SDI connector to connect a video source.

10 HDMI

HDMI 1.4 connector to connect a video source.

11 DisplayPort A (B)

DisplayPort connector to connect a video source.

5.5 ICMP DisplayPort specifications

DisplayPort



Digital display interface developed by the Video Electronics Standards Association (VESA). This royalty-free interface is primarily used to connect a video source to a display device such as a computer monitor, though it can also be used to transmit audio, USB, and other forms of data. VESA designed it to replace VGA, DVI, and FPD-Link. Backward compatibility to VGA and DVI by using active adapter dongles enables users to use DisplayPort fitted video sources without replacing existing display devices.

HDCP



High-bandwidth Digital Content Protection is a form of digital copy protection developed by Intel Corporation to prevent copying of digital audio and video content as it travels across DisplayPort, Digital Visual Interface (DVI), High-Definition Multimedia Interface (HDMI), Gigabit Video Interface (GVIF), or Unified Display Interface (UDI) connections, even if such copying would be permitted by fair use laws. The specification is proprietary, and implementing HDCP requires a license.

DisplayPort specifications

Supported Modes:

- DP1.1a, 4-lanes RBR/HBR
- Audio : yes
- Content Protection : HDCP1.4
- Color Depth : 8 bit/component and 10 bit/component.
- 3D-stereo mode : frame sequential (embedded stereosync on DP required from the source)

DisplayPort A and DisplayPort B accept the following video-timings:

2D Formats / Single DP	Color depth	Port	Display Mode
640 x 480 @ 60 fps	8 bpc, 10 bpc	Single	2D
800 x 600 @ 60 fps	8 bpc, 10 bpc	Single	2D
1600 x 1200 @ 60 fps	8 bpc, 10 bpc	Single	2D
1280 x 800 @ 60 fps	8 bpc, 10 bpc	Single	2D
1280 x 720 @ 60 fps	8 bpc, 10 bpc	Single	2D
1680 x 1050 @ 60 fps	8 bpc, 10 bpc	Single	2D

2D Formats / Single DP	Color depth	Port	Display Mode
1920 x 1080 @ 60 fps	8 bpc, 10 bpc	Single	2D
1920 x 1200 @ 60 fps	8 bpc, 10 bpc	Single	2D
2048 x 1080 @ 48, 60 fps	8 bpc, 10 bpc	Single	2D
2048 x 1536 @ 60 fps	8 bpc, 10 bpc	Single	2D
2048 x 2160 @ 30, 48, 50, 60 fps	8 bpc, 10 bpc	Single	2D
3840 x 2160 @ 24 fps	8 bpc, 10 bpc	Single	2D
3D Formats / Single DP	Color depth	Port	Display Mode
1920 x 1080 @ 60 fps	8 bpc, 10 bpc	Single	3D
2048 x 1080 @ 60 fps	8 bpc, 10 bpc	Single	3D
4K Horizontal SPAN 2D - Full	Color depth	Port	Display Mode
2048 x 2160 @ 30, 48, 50, 60 fps	8 bpc, 10 bpc	A+B span	2D
4K Horizontal SPAN 2D - Flat	Color depth	Port	Display Mode
1920 x 2160 @ 30, 48, 50, 60 fps	8 bpc, 10 bpc	A+B span	2D
4K Horizontal SPAN 3D	Color depth	Port	Display Mode
2048 x 2160 @ 60 fps	8 bpc, 10 bpc	A+B span	3D

Audio formats

- 2 channels / LPCM / 16 bits / 32 kHz, 44.1 kHz, 48 kHz, 88.2 kHz, 96 kHz
- 5.1 format / LPCM / 24 bits / 48 kHz
- 7.1 format / LPCM / 20 bits / 48 kHz

Notes:

- DisplayMode = Single : is applicable to both DisplayPort A, and DisplayPort B input, separately.
- DisplayMode = A+B : inputs DisplayPort A and DisplayPort B are combined to 1 larger image; in this case the 2 DisplayPort links need to be genlocked (= synchronous and in phase).
- In all cases :
 - Color Space - Color Sampling:
 - YCbCr - 4:4:4
 - YCbCr - 4:2:2
 - RGB - 4:4:4
 - Scan Type = progressive.
- Both Nvidia and AMD GPU's will not support color depths of 10 bits/color while in 3D-stereo mode.
- Some Graphical Cards may not permit 10 bits/color at all video timings, because of bandwidth restrictions.
- DisplayPort A and DisplayPort B automatically detect:
 - Active Pixels, and Active Lines
 - Vertical Refresh
 - 8 bits/color - 10 bits/color
 - Frame locked
- All input resolutions are scaled towards the desired resolution specified in the screen presentation file.
- Fractional frame rates = (Hz*1000)/1001

5.6 ICMP SDI specifications

3G-SDI



Serial Digital Interface (SDI) is a serial link standardized by ITU-R BT.656 and the Society of Motion Picture and Television Engineers (SMPTE). SDI transmits uncompressed digital video over 75-ohm coaxial cable within studios, and is seen on most professional video infrastructure equipment. The first revision of the standard, SMPTE 259M, was defined to carry digital representation of analog video such as NTSC and PAL over a serial interface and is more popularly known as standard-definition (SD) SDI. The data rate required to transmit SD SDI is 270 Mbps. With the advent of high-definition (HD) video standards such as 1080i and 720p, the interface was scaled to handle higher data rates of 1.485 Gbps. The 1.485-Gbps serial interface is commonly called the HD SDI interface and is defined by SMPTE 292M, using the same 75-ohm coaxial cable. Studios and other video production facilities have invested heavily on the hardware infrastructure for coaxial cable and have a vested interest in extending the life of their infrastructure. Fortunately, SMPTE recently ratified a new standard called SMPTE 424M that doubles the SDI data rates to 2.97 Gbps using the same 75-ohm coaxial cable. This new standard, also called 3-Gbps (3G)-SDI, enables higher resolution of picture quality required for 1080p and digital cinema.

SDI terminology

Standard HD-SDI signal

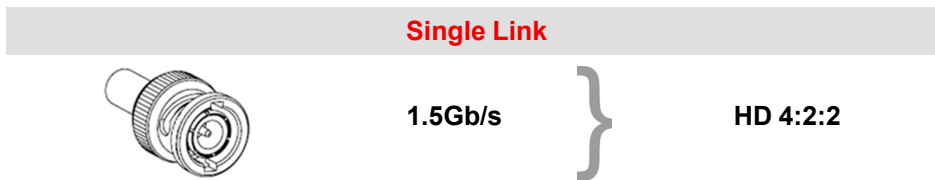

Standard HD-SDI allows for a single 4:2:2 image to be carried on one cable at 1.485 Gb/s. The image uses the Y Cb Cr colorspace and uses a bit depth of 10 bit per color component.

Due to the data rate limitations only 23.976, 24, 25, 29.970 and 30 fps streams are achievable.

Dual-Link HD-SDI signal

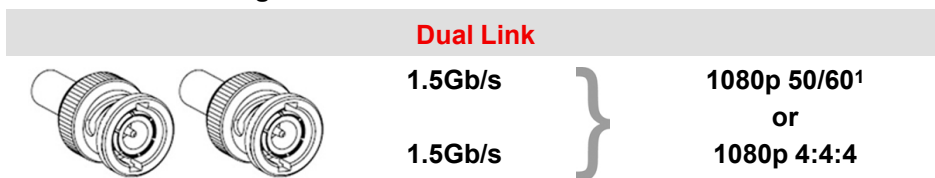

Dual-Link HD-SDI is mainly two standard HD-SDI signals carrying a single image stream split between the two cables. The main advantage is that color subsampling is no longer required, and the image can be transmitted in 4:4:4 quality, which then also allows the RGB (or XYZ) color space to be used.

The main link will contain a standard HD-SDI signal, the second (enhancement) link contains the missing Cb and Cr samples.

Depending on the implementation the enhancement link could also contain extra information to increase the bit depth.

3G HD-SDI signal

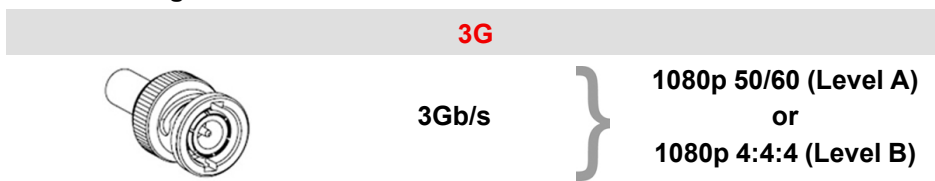

3G HD-SDI uses a higher data rate (2.97 Gb/s). This allows a single cable interface to achieve the same capabilities of a Dual-Link HD-SDI implementation.

1: Not supported in Alchemy

In direct mapping (level A) this is used to achieve higher frame rates. (50, 59.940 and 60 fps streams are supported).

Dual Stream 3G HD-SDI signal

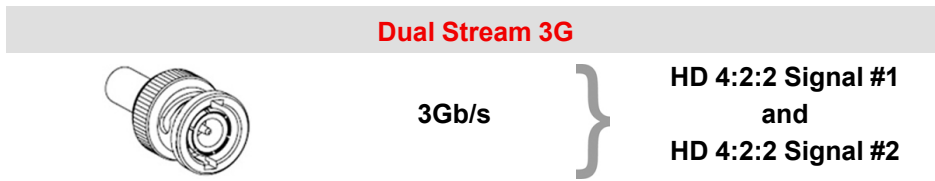

Dual Stream 3G is a specific variant of the 3G signal which combines two completely separate 4:2:2 image streams into a single 3G signal. This can be used to transmit stereoscopic streams by keeping the left and right eye signals together.

SMPTE 292M STANDARD 1.485 Gb/s HD-SDI SIGNALS

Standard HD-SDI (SMPTE 292M) formats

SMPTE Standard	Source Resolution	Frame Rate	Display Rate	Scan Type			
SMPTE 296M	1280 x 720	23.976	23.976	Progressive Y Cb Cr 4:2:2 10-Bit			
		24	24				
		25	25				
		29.970	29.970				
		30	30				
		50	50				
		59.940	59.940				
SMPTE 274M SMPTE 428-8	1920 x 1080 2048 x 1080	23.976	23.976	Progressive Y Cb Cr 4:2:2 10-Bit			
		24	24				
		25	25				
		29.97	29.97				
		30	30				
		SMPTE 274M SMPTE 428-9 (SMPTE RP211)	1920 x 1080 2048 x 1080		23.976	23.976	Segmented frame Y Cb Cr 4:2:2 10-Bit
					24	24	
25	25						
29.97	29.97						
30	30						
SMPTE 274M	1920 x 1080	25	50	Interlaced Y Cb Cr 4:2:2 10-Bit			
		29.970	59.940				
		30	60				

Dual-Link HD-SDI (SMPTE 372M) formats

SMPTE Standard	Source Resolution	Frame Rate	Display Rate	Scan Type
SMPTE 274M	1920 x 1080	23.976	23.976	Progressive
SMPTE 428-8	2048 x 1080	24	24	Y Cb Cr 4:2:2 12-Bit only
		25	25	Y Cb Cr 4:4:4 10 or 12-Bit
		29.970	29.970	RGB (XYZ) 4:4:4 10 or 12-Bit
		30	30	
SMPTE 274M	1920 x 1080	23.976	23.976	Segmented frame
SMPTE 428-9 (SMPTE RP211)	2048 x 1080	24	24	Y Cb Cr 4:2:2 12-Bit only
		25	25	Y Cb Cr 4:4:4 10 or 12-Bit
		29.970	29.970	RGB (XYZ) 4:4:4 10 or 12-Bit
		30	30	
SMPTE 274M	1920 x 1080	25	50	Interlaced
		29.970	59.940	Y Cb Cr 4:2:2 12-Bit only
		30	60	Y Cb Cr 4:4:4 10 or 12-Bit RGB (XYZ) 4:4:4 10 or 12-Bit

Standard HD-SDI (2 × SMPTE 292M) formats²

SMPTE Standard	Source Resolution	Frame Rate	Display Rate	Scan Type
SMPTE 292M	1920 x 1080	23.976	47.952	Progressive
SMPTE 428-8	2048 x 1080	24	48	Y Cb Cr 4:2:2 10-Bit
		25	50	
		29.97	59.940	
		30	60	
SMPTE 292M	1920 x 1080	23.976	47.952	Segmented frame
SMPTE 428-9 (SMPTE RP211)	2048 x 1080	24	48	Y Cb Cr 4:2:2 10-Bit
		25	50	
		29.97	59.940	
		30	60	

The standard HD-SDI interfaces support the Y Cb Cr colorspace (both legal and full range) using 4:2:2 color subsampling.

The Dual-Link HD-SDI interface can be used to carry a single 4:4:4 image, having a color depth of 10 or 12 bit per component. Both RGB (XYZ) and Y Cb Cr color spaces are supported.

SMPTE 424M 3G HD-SDI 2.970 Gb/s SIGNALS

3G HD-SDI (SMPTE 425) formats

²: mainly used to carry stereoscopic images.

SMPTE Standard	Source Resolution	Frame Rate	Display Rate	Scan Type
SMPTE 296M	1280 x 720	23.976	23.976	Progressive
		24	24	Y Cb Cr 4:4:4 10-Bit
		25	25	RGB (XYZ) 4:4:4 10-Bit
		29.970	29.970	
		30	30	
		50	50	
		59.940	59.940	
SMPTE 274M ³	1920 x 1080	50	50	Progressive
		59.940	59.940	Y Cb Cr 4:2:2 10-Bit
		60	60	
SMPTE 274M	1920 x 1080	23.976	23.976	Progressive
		24	24	Y Cb Cr 4:2:2 12-Bit only
		25	25	Y Cb Cr 4:4:4 10 or 12-Bit
		29.97	29.97	RGB (XYZ) 4:4:4 10 or 12-Bit
		30	30	
SMPTE 274M	1920 x 1080	50	50	Interlaced
		59.940	59.940	Y Cb Cr 4:2:2 12-Bit only
		60	60	Y Cb Cr 4:4:4 10 or 12-Bit RGB (XYZ) 4:4:4 10 or 12-Bit
SMPTE 428-9	2048 x 1080	23.976	23.976	Progressive
		24	24	Y Cb Cr 4:4:4 12-Bit RGB (XYZ) 4:4:4 12-Bit

Dual Stream 3G HD-SDI (SMPTE 425) formats

SMPTE Standard	Source Resolution	Frame Rate	Display Rate	Scan Type
SMPTE 292M	1920 x 1080	23.976	47.952	Progressive
SMPTE 428-9	2048 x 1080	24	48	Y Cb Cr 4:2:2 10-Bit
		25	50	
		29.970	59.940	
		30	60	

5.7 ICMP HDMI 2.0 specifications

HDMI



HDMI (High-Definition Multimedia Interface) is a compact audio/video interface for transferring uncompressed video data and compressed/uncompressed digital audio data from a HDMI-compliant device ("the source device") to a compatible computer monitor, video projector, digital television, or digital audio device. HDMI is a digital replacement for existing analog video standards.

HDMI 2.0 specifications

HDMI

Both HDMI 2.0 inputs are fully compliant with the HDMI 1.4, 1.4a, 1.4b, 2.0 and 2.0a revisions of the HDMI specification.

3: only supported in 3G level A mapping, others formats are supported in both level A and level B mapping.

Full Range and Limited Range Quantization are supported for all specified formats.

BT.709 and DCI-P3 are supported for all formats. For HDR content (UHD and 4K only) the BT.2020 color coding is supported.

All video streams should have a progressive scan order, with the exception of 1920x1080i 60 fps (interlaced scan).

HDCP

Both HDMI 2.0 inputs are HDCP 1.4 & HDCP 2.2 compliant.

HDR (SMPTE ST 2084)

HDR (High Dynamic Range) is supported on all UHD and 4K formats.

This includes SMPTE ST 2084 (static metadata) and BT.2020 color coding. Requires a license!

HDMI 2.0 Cable requirements

All HDMI cables should work with HDMI 2.0 receivers. There is no such thing as a “4K HDMI cable” even though this is sometimes sold this way. But of course there are quality differences. The “high-speed” cables would be preferred over the “standard-speed” cables. They usually work at higher cable lengths than the standard-speed ones.



The “Premium Certified HDMI” cables are tested to work with high bandwidth as is the case with 4K HDR content. These can be more expensive though. When using active and/or optical cables you should verify if the integrated receiver and sender are HDMI certified to guarantee to work compliant with the HDMI protocol. You can request the HDMI certificate to the manufacturer of the cable.



The ICMP is not supporting Ethernet-over-HDMI and such specific cables are thus not required.

HDMI 2.0 Supported 2D Formats

Format	Frame Rate	Color coding	Bit depth
1280x720	23.976	RGB	8
	24	YCbCr 4:4:4	10
	25	YCbCr 4:2:2	12
	29.97		
	30		
	50		
	59.94		
1280x720	100	RGB	8
	119.88	YCbCr 4:4:4	
	120	YCbCr 4:2:2	
1920x1080	23.976	RGB	8
2048x1080	24	YCbCr 4:4:4	10
	25	YCbCr 4:2:2	12
	29.97		
	30		
	50		
	59.94		

Format	Frame Rate	Color coding	Bit depth
	60		
1920x1080	100	RGB	8
2048x1080	119.88	YCbCr 4:4:4	
	120	YCbCr 4:2:2	
3840x2160	23.976	RGB	8
4096x2160	24 25	YCbCr 4:4:4	10
	29.97	YCbCr 4:2:2	12
	30		
3840x2160	50	RGB	8
4096x2160	59.94	YCbCr 4:4:4	
	60	YCbCr 4:2:2	

HDMI 2.0 Supported 3D (Frame Packing) Formats

Format	Frame Rate	Color coding	Bit depth
1920x1080	23.976	RGB	8
2048x1080	24	YCbCr 4:4:4	10
	25	YCbCr 4:2:2	12
	29.97		
	30		
1920x1080	50	RGB	8
2048x1080	59.94	YCbCr 4:4:4	
	60	YCbCr 4:2:2	
3840x2160	23.976	RGB	8
4096x2160	24 25	YCbCr 4:4:4	10
	29.97, 30	YCbCr 4:2:2	12
3840x2160	50	RGB	8
4096x2160	59.94	YCbCr 4:4:4	
	60	YCbCr 4:2:2	

HDMI 2.0 Supported Audio Formats

Format	Sample Rate	Sample coding	Bit depth
2.0	32	L-PCM	16
2.1	44.1		20
5.1	48		24
7.1	88.2		
	96		

HDMI 2.0 Supported Dual (Twin) Link Formats (2D formats only)

Format	Frame Rate	Color coding	Bit depth
1920x1080	23.976	RGB	8
2048x1080	24	YCbCr 4:4:4	
	25	YCbCr 4:2:2	
	29.97		
	30		
	50		
	59.94		
	60		
3840x2160	23.976	RGB	
4096x2160	24	YCbCr 4:4:4	
	25	YCbCr 4:2:2	
	29.97		
	30		
	50		
	59.94		
	60		

 In Dual (Twin) Link both HDMI2 inputs (port A & port B) should have to same Format, Frame Rate and Color coding.

 Port A should contain the 8 most significant bits of the pixel data, where port B should contain the 8 least significant bits of the pixel data. The pixel data will be reconstructed using the all 8 bits of port A and using the 4 most significant bits of port B.

HDMI 2.0 Supported Passive 3D Formats (3D formats only)

Format	Frame Rate	Color coding	Bit depth
1920x1080	24	RGB	8
2048x1080	30	YCbCr 4:4:4	10
		YCbCr 4:2:2	12
1920x1080	60	RGB	8
2048x1080		YCbCr 4:4:4	
		YCbCr 4:2:2	
3840x2160	24	RGB	8
4096x2160	30	YCbCr 4:4:4	
		YCbCr 4:2:2	

 In Passive 3D HDMI2 input port A should contain the pixel data of Left Eye and HDMI2 input port B should contain the pixel data for Right Eye.

5.8 ICMP HDMI 1.4 specifications

HDMI

 HDMI (High-Definition Multimedia Interface) is a compact audio/video interface for transferring uncompressed video data and compressed/uncompressed digital audio data from a HDMI-compliant device ("the source device") to a compatible computer monitor, video projector, digital television, or digital audio device. HDMI is a digital replacement for existing analog video standards.

HDMI 1.4 specifications

HDMI1.4a, including HDCP1.4

HDMI 1.4 Supported 2D Formats (progressive)

Format	Frame Rate	Color coding	Bit depth
720x480	60	RGB	(8)
		YCbCr 4:4:4	10
		YCbCr 4:2:2	12
720x576	50	RGB	(8)
		YCbCr 4:4:4	10
		YCbCr 4:2:2	12
1280x720	23.976	RGB	8
	24	YCbCr 4:4:4	10
	25	YCbCr 4:2:2	12
	29.97		
	30		
	50		
	59.94		
	60		
	100		
	119.88		
	120		
1680x720	23.976	RGB	8
	24	YCbCr 4:4:4	10
	25	YCbCr 4:2:2	12
	29.97		
	30		
	50		
	59.94		
	60		
	100		
	119.88		
	120		
1920x1080	23.976	RGB	8
2048x1080	24	YCbCr 4:4:4	10
	25	YCbCr 4:2:2	12
	29.97		
	30		
	50		
	59.94		
60			
1920x1080	100	RGB	8
2048x1080	119.88	YCbCr 4:4:4	
	120	YCbCr 4:2:2	

Format	Frame Rate	Color coding	Bit depth
2560x1080	23.976	RGB	8
	24	YCbCr 4:4:4	10
	25	YCbCr 4:2:2	12
	29.97		
	30		
	50		
	59.94		
3840x2160	23.976	RGB	8
		YCbCr 4:4:4	10
4096x2160	24	YCbCr 4:2:2	12
	25		
	29.97		
	30		

HDMI 1.4 Supported 2D (Interlaced) Formats

Format	Frame Rate	Color coding	Bit depth
720x576	25		
	50		
	100		
1920x1080	25		
	29.97		
	30		
	50		
	59.94		
	60		

HDMI 1.4 Supported 3D (Frame Packing) Formats

Format	Frame Rate	Color coding	Bit depth
1280x720	50		
	59.94		
	60		
1920x1080	23.98		
	24		

HDMI 1.4 Supported 3D (Top Bottom) Formats

Format	Frame Rate	Color coding	Bit depth
1280x720	50		
	59.94		
	60		
1920x1080	23.98		
	24		

HDMI 1.4 Supported Audio Formats

Format	Sample Rate	Sample coding	Bit depth
2 channels	32	L-PCM	16
	44		
	48		
	88		
	96		
5.1 channels	24	L-PCM	48
7.1 channels	20	L-PCM	48

5.9 ICMP status LEDs

ICMP status LEDs and Reset button

LEDs on ICMP front panel give information on the status of the device.

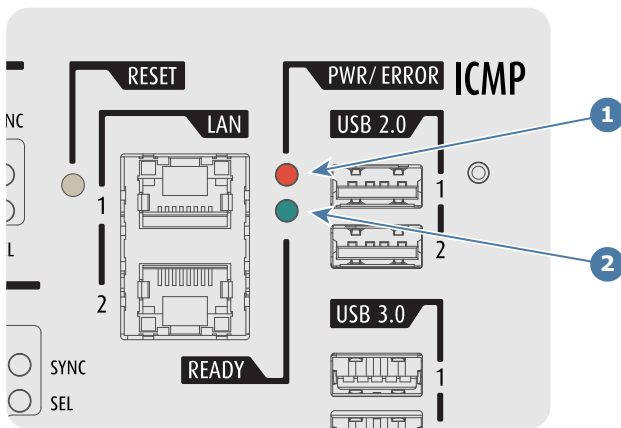

Image 5-10

Status overview PWR/ERROR and READY LEDs:

1 PWR/ERROR	2 READY	ICMP Status
Off	Off	Turned off
Red	Off	Board reset or FIPS error
Blinking Green	Off	Boot loader
Blinking Green	Blinking Orange	Operating System start up
Blinking Green	Orange	Security Manager - Image Integrity tests
Blinking Green	Blinking Yellow	Security Manager - Self Test
Blinking Green	Yellow	Security Manager - FPGA self-test

1	2	
PWR/ERROR	READY	ICMP Status
Green	Blinking Green	Starting Applications
Green	Green	Applications started in normal mode
Green	Orange	Applications started in degraded mode
Blinking Red	Off	FIPS error
Green	Blinking Orange	Update ongoing
Orange	Orange	Update done

5.10 ICMP HDD status LEDs

ICMP HDD status LEDs

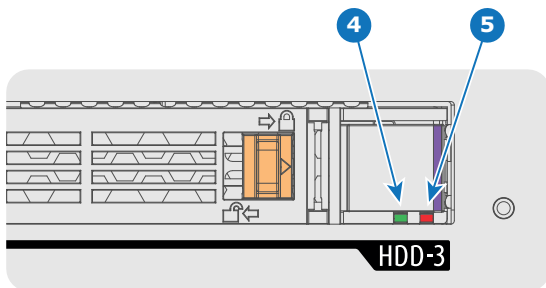

Image 5-11

Status overview PWR/ERROR and READY LEDs:

4	5	
HDD I/O	RAID	ICMP HDD Status
Off	Off	HDD idle / Disk in RAID OK.
Blinking Green	Off	HDD I/O activity / Disk in RAID OK.
Blinking Green	Blinking Red	HDD I/O activity / RAID rebuilding.
Off	Red	HDD idle / Disk error. See troubleshooting table below for curative act

Troubleshooting

Situation

One disk failed (red LED) + **RAID degraded**.

The ongoing event is not interrupted.

Note: The disk status (RAID degraded) can be retrieved via the (Web) Commander. See user guide of the (Web) Commander.

One disk failed (red LED) + Error 10580 "**local storage not available**".

Note: The disk status (Error code) can be retrieved via the (Web) Commander. See user guide of the (Web) Commander.

Multiple disks failed (multiple red LEDs) + **RAID broken**.

Note: The disk status (RAID broken) can be retrieved via the (Web) Commander. See user guide of the (Web) Commander.

All HDD LEDs remain off + Error 10580 "**local storage not available**".

Note: The disk status (Error code) can be retrieved via the (Web) Commander. See user guide of the (Web) Commander.

Solution

1. Switch off the power.
2. Replace the defect HDD with approved model of the same storage capacity. See procedure "Removing a HDD from the ICMP", page 62, and "Installing a HDD into the ICMP", page 63. Ensure to insert the HDD firmly.
3. Switch on the power.

Result: As soon the new HDD is detected by the ICMP the rebuild of the RAID is started (Blinking red LED).

1. Switch off the power.
2. Replace the defect HDD with approved model of the same storage capacity. See procedure "Removing a HDD from the ICMP", page 62, and "Installing a HDD into the ICMP", page 63. Ensure to insert the HDD firmly.
3. Switch on the power.

Result: As soon the new HDD is detected by the ICMP the rebuild of the RAID is started (Blinking red LED).

1. Switch off the power.
2. Replace all defect HDDs with approved models of the same storage capacity. See procedure "Removing a HDD from the ICMP", page 62, and "Installing a HDD into the ICMP", page 63. Ensure to insert the HDDs firmly.
3. Switch on the power.
4. Start "RAID Initialize". See user guide of the Communicator.

Result: a new empty RAID is created.

1. Switch off the power.
2. Reseat all HDDs. See procedure "Removing a HDD from the ICMP", page 62, and "Installing a HDD into the ICMP", page 63. Ensure to insert the HDDs firmly.
3. If problem remains try "RAID Initialize". See user guide of the Communicator. Note that all content will be lost!
4. If problem remains contact Service for further instructions.



In case the ICMP has to be returned to factory (e.g. for repair) the non defective HDDs should be removed and kept.

5.11 ICMP device certificate

Purpose of the Barco ICMP device certificate

The device certificate (*.pem) of the Barco ICMP is a digital certificate signed by Barco which is required when ordering the KDM to play a DCP that is ingested on the ICMP. The device certificate is stored inside the ICMP and on a web server.

The (WEB) Commander or Communicator can be used to retrieve the device certificate directly from the ICMP. To retrieve the device certificate from the website the QR (Quick Response) code can be used. See procedure “Obtaining the Barco ICMP certificate”, page 61.

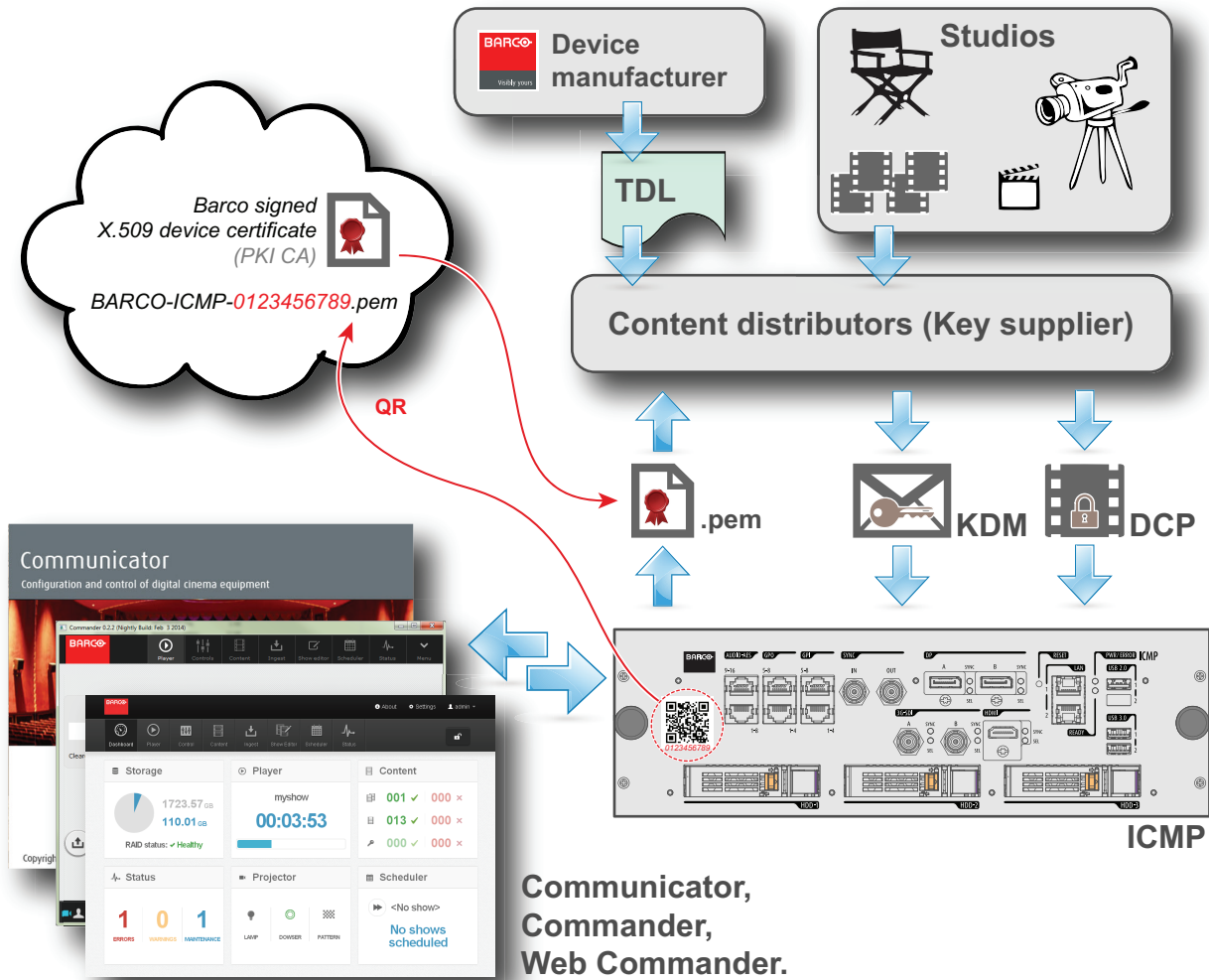

Image 5-12

Trusted Device List (TDL)



The Goal of the TDL is to maintain timely and accurate information on participating auditoriums so that participating subscribers can obtain information needed to issue KDMs. The TDL has several data sources: Device manufacturers, Exhibitors, Deployment Entities, Integrators, Service Providers (interacting with Exhibitors), regional authorities and Support.

Public Key Infrastructure (PKI)



PKI is a framework for creating a secure method for exchanging information based on public key cryptography. The foundation of a PKI is the certificate authority (CA), which issues digital certificates that authenticate the identity of organizations and individuals over a public system such as the Internet. The certificates are also used to sign messages, which ensures that messages have not been tampered with.

***.pem**



Privacy-enhanced Electronic Mail. File format used to distribute digital signed certificates. Base64 encoded DER certificate, enclosed between "-----BEGIN CERTIFICATE-----" and "-----END CERTIFICATE-----"

Key Delivery Message (KDM)

The security key for each movie is delivered in a unique KDM for each digital cinema server. The security key is encrypted within the KDM, which means that the delivery of a KDM to the wrong server or wrong location will not work, and thus such errors cannot compromise the security of the movie. The KDM is a small file, and is typically emailed to the exhibitor. To create the correct set of KDMs for a site requires knowledge of the digital certificate in the projection system's media block.

Digital Cinema Package (DCP)

A Digital Cinema Package (DCP) is a collection of digital files used to store and convey Digital Cinema (DC) audio, image, and data streams. The term has been defined by Digital Cinema Initiatives (DCI). General practice adopts a file structure that is organized into a number of usually multi-gigabyte size Material eXchange Format (MXF) files, which are separately used to store audio and video streams, and auxiliary index files in XML format. The MXF files contain streams that are compressed, encoded, and encrypted, in order to reduce the huge amount of required storage and to protect from unauthorized use. The image part is JPEG 2000 compressed, whereas the audio part is linear PCM. The adopted (optional) encryption standard is AES 128 bit in CBC mode. The newer SMPTE standards are used to conform the recommendations among different tool vendors and producers. Interop, the legacy DCP standard, is still required to be supported by DCP players.

Digital Cinema Initiatives (DCI)

DCI is a joint venture of Disney, Fox, Paramount, Sony Pictures Entertainment, Universal and Warner Bros. Studios. DCI's primary purpose is to establish and document voluntary specifications for an open architecture for digital cinema that ensures a uniform and high level of technical performance, reliability and quality control. Note that the DCI specification is not a standard. Standards for digital cinema are the domain of the Society of Motion Picture and Television Engineers (SMPTE). "DCI compliant" is a term used to describe products that conform to the DCI specification. Products that have been tested per the DCI Compliance Test Plan (CTP) are posted at the DCI compliance web site. Notably, DCI compliance does not require compliance to the full set of SMPTE DCP standards. A copy of the most recent DCI specification can be downloaded from the DCI website (<http://dcimovies.com>).

5.12 ICMP configuration via Communicator

About ICMP configuration

Following parameters are available to configure the ICMP:

- Global settings: allows defining name of the ICMP, host name (network identifier) and IP address which can be used for communication with external content devices.
- User settings: definition of all users allowed on the ICMP.
- Server settings: definition of access to servers and storage libraries of content (movies, KDM, etc.).
- Player settings: Audio delay and audio output frequency.
- Audio channel: allows defining the mapping of audio channels (content) on each audio output (AES outputs of the ICMP).
- Scheduler setting: Enable/Disable scheduler at startup, delays allowed in scheduler mode and length of schedule history.
- Devices: allows defining communication ports settings, to access external devices controlled by the automation.
- Automation Cues: event cues that are triggered from different sources and to which can be assigned actions to be executed by the automation engine.
- Verify internal clock of the ICMP.



All installation and maintenance operations on the ICMP are performed via Communicator, the Barco configuration software. Please refer to the Communicator user guide for further information.

About Default settings

The restore of factory setting is a feature that allows removing all settings performed on the ICMP and replaces them with the default values set at the factory. Please refer to the Communicator user guide for further information.

About the ICMP internal clock

The crystal on the ICMP board that manages the clock shows a certain drift (all crystals do). With the Communicator the internal clock can be adjusted. This maintenance action should be repeated every 3 months. When neglected the system will lock up.

From ICMP software version 1.2.1 onwards it is possible to enable NTP (Network Time Protocol). You have to configure (at installation) an IP address where the ICMP can find a sync signal. From then on, and as long as the connection is active, the ICMP will automatically keep its clock correct. For detailed instructions see user guide of the Communicator.

5.13 ICMP reset



This procedure requires that ICMP version 1.2.4 or later is installed.

ICMP reset possibilities

- The Star button on the local keypad (Not for C- and B-series)
- The ICMP reset button in the GUI of the Communicator.
- The ICMP reset button in the GUI of the Commander.
- The ICMP reset button in the GUI of the Web Commander.
- The ICMP hardware reset button located on the front panel of the ICMP (Not recommended, use only when all other reset possibilities are exhausted!)

How to reset the ICMP?

1. Click on the ICMP **reset button** in the GUI of the **Web Commander**

or

Click on the ICMP **reset button** in the GUI of the **Commander**



Note: It can be that the Commander or WEB-Commander is not able to send the reset command.

or

click on the ICMP **reset button** in the GUI of the **Communicator** (recommended)

or

press the **Star button** on the **local keypad** for a few seconds (Not for C- and B-series)

As a result the projector is safely prepared for the ICMP reboot. All ongoing events on the ICMP (e.g. ingest) are requested to end. After a few seconds the ICMP is requested to restart. The READY LED on the front panel of the ICMP starts to blink orange.

In case the ICMP is installed in DP4K-L series projector the lasers are switched off and the projector remains in the same mode (e.g. Conditioned). The Star button on the local keypad starts blinking green. After the reset of the ICMP the lasers are switched on again.

Once the READY LED lit continuous green the ICMP is up and running.

2. Did the reset of the ICMP fail?

► **If yes**, perform a hardware reset as follows:

1. switch off the lasers of the projector or switch of the projector lamp.
2. press the ICMP **hardware reset button** a few seconds (reference 3 Image 5-13) .



Warning: Resetting the ICMP with the hardware reset button may cause damage to the content on the HDDs. A re-configuration of the whole system may be required!

As a result the projector is safely prepared for the ICMP reboot. All ongoing events on the ICMP (e.g. ingest) are stopped immediately and the ICMP restarts.

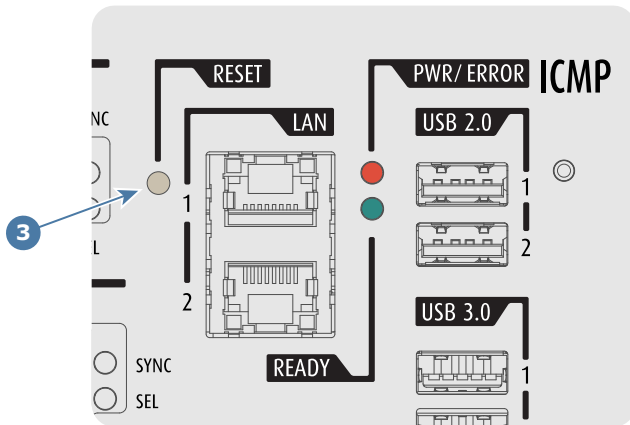

Image 5-13



WARNING: Resetting the ICMP with the hardware reset button may cause damage to the content on the HDDs. A re-configuration of the whole system may be required!

5.14 Obtaining the Barco ICMP certificate

Required tools

Smartphone (with auto-focus) or control software (e.g. Communicator, Commander or WEB Commander)

Using the CertID label to download the ICMP certificate

1. Scan the QR code (reference 1) on the front face of the ICMP with a smartphone. It's recommended to use a smartphone with auto-focus. The QR reader will automatically redirect to the ICMP certificate download page on the web server.



Note: Instead of downloading the ICMP certificate you can use the CertID number (reference 2), located below the QR code, in communication with your KDM supplier. Certified KDM suppliers can use this CertID number to retrieve the ICMP certificate directly.

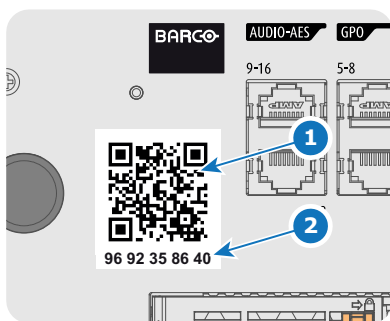

Image 5-14

Using control software to obtain the ICMP certificate

1. Use the **WEB Commander** to download the ICMP certificate from the ICMP main board. For detailed instructions see user guide of the WEB Commander.

or

use the **Commander** to download the ICMP certificate from the ICMP main board. For detailed instructions see user guide of the Commander.

or

use the **Communicator** to download the ICMP certificate from the ICMP main board. For detailed instructions see user guide of the Communicator.

5.15 Removing a HDD from the ICMP



In case the ICMP has to be returned to factory (e.g. for repair) the non defective HDDs should be removed and kept.

How to remove a HDD ?

1. Switch off the projector.
2. Moving the latch towards the left.

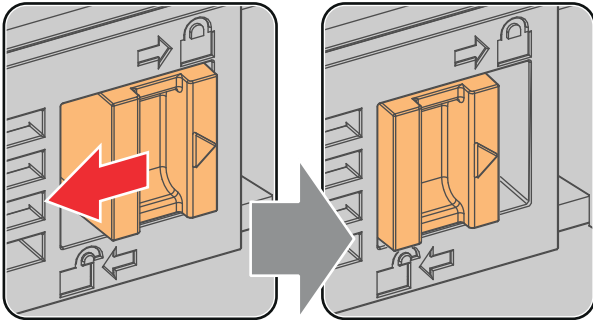

Image 5-15

3. Push the unlock button to open the handle.

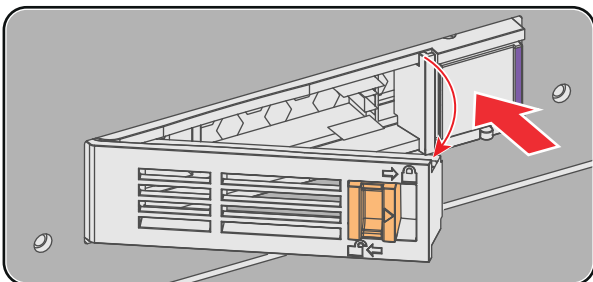

Image 5-16

4. Pull the HDD out of its slot.

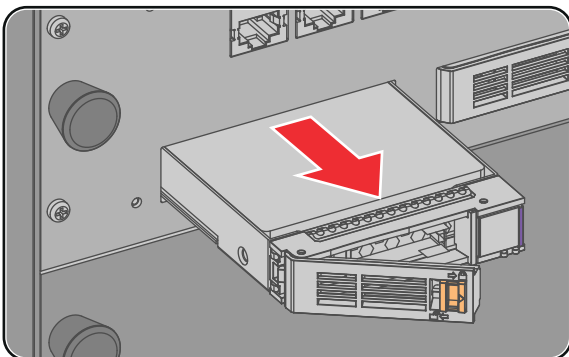

Image 5-17



To install the HDD see procedure “Installing a HDD into the ICMP”, page 63.

5.16 Installing a HDD into the ICMP



This procedure assumes that the HDD slot of the ICMP is empty. If not, see procedure “Removing a HDD from the ICMP”, page 62.



CAUTION: Always use a new empty spare part HDD approved by Barco to replace a malfunction HDD. Do not use a HDD from another ICMP HDD set.



CAUTION: Always make sure that all HDDs in the ICMP HDD set have the same storage capacity. See label on top of the HDD to know the storage capacity.

How to install a HDD ?

1. Ensure that the projector is switched off.
2. Prepare the HDD for insertion by moving the latch towards the left and push the unlock button to open the handle.

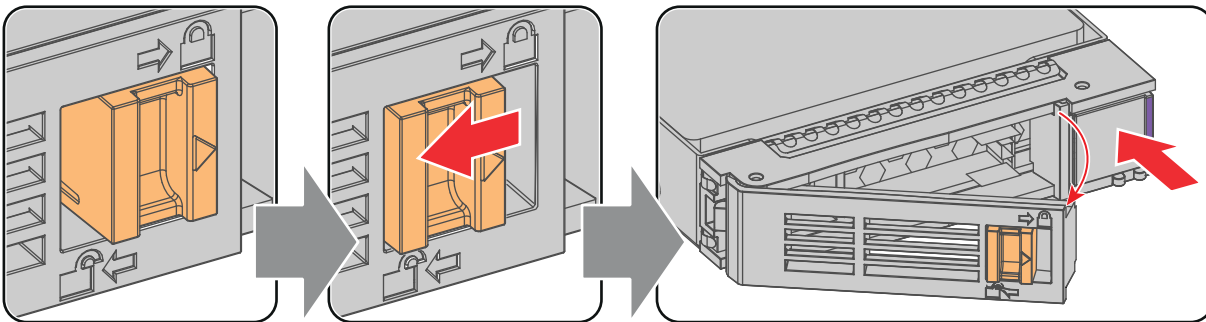

Image 5-18

3. Insert the HDD into the HDD slot. Ensure that the handle is sufficiently open so that the hook (reference 1) of the handle can pass the front plate of the ICMP.

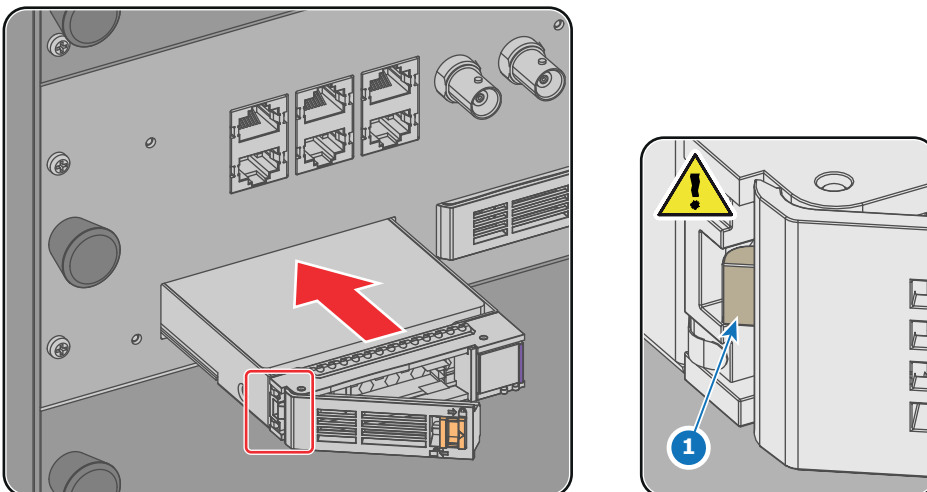

Image 5-19

4. Push the HDD completely and firmly inside its slot, close the handle, and move the latch towards the right.

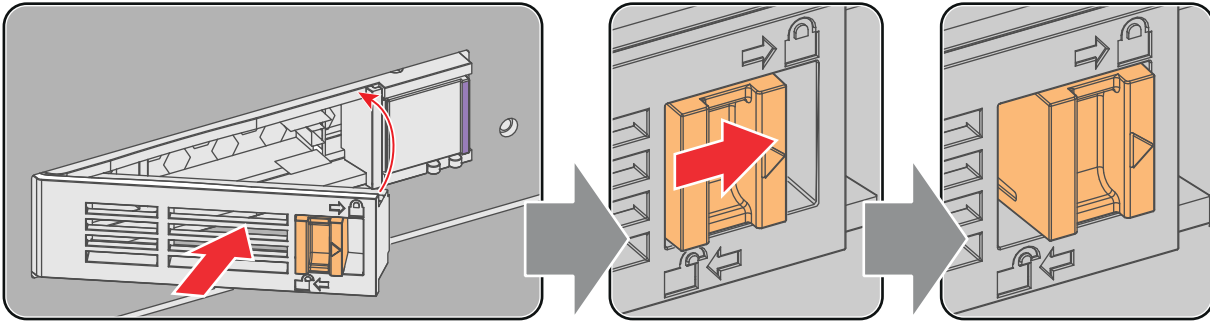

Image 5-20

5. Switch on the projector.



In case you replace one HDD (e.g. degraded mode) the ICMP automatically starts with the RAID recovery process. The red LED of the HDD which has to be rebuilt is blinking. This process takes about 200 GB per hour. Once the RAID is completed the red LED turns off.



CAUTION: It's strongly recommended to complete the RAID recovery process prior to starting a show. This to ensure that the content integrity is preserved and that the show is not interrupted.

Starting up

6

About this chapter

This chapter contains the switch ON and switch OFF procedures of your Thor. These procedures highlight all important points to be checked prior to switching the projector ON. This is to ensure a safe startup of the projector.

Overview

- Switching the Thor ON
- Switching the Thor OFF
- Projector ON/OFF cycle explained

6.1 Switching the Thor ON

About the start up process

To start up the Thor the sealed compartment of the Light Processor and the sealed compartment of the Laser Clusters must be brought into a 'condition' which is safe for the electronics to operate (avoid moisture due to extreme cooling). In other words, the temperature and humidity inside these compartments must be brought within specs prior to activating the lasers and Light Processor. The time needed to bring the projector from a **deconditioned** state into a **conditioned** state depends on the ambient conditions and can take several minutes. This process is called **conditioning**.

Start up checklist

1. Check if the chiller is correctly installed. See documentation set of the chiller.
2. Check if the chiller is equipped with the expansion unit for DMD cooling.
3. Check if the Thor is installed onto a stable platform and all covers are installed..
4. Check if all hoses are properly connected with the chiller and projector. .
5. Check if the data cables between chiller and projector are correctly installed.
6. Check if the projector is connected with the mains electricity.
7. Check if the ambient temperature and humidity are within specifications..
8. Check if the chiller, hoses and projector are completely acclimatized to the same ambient temperature.
9. Check if the correct lens is installed for the application and the lens cap is removed from the lens. See chapter "Lens installation", page 23.
10. Check if the small drain tubes at the bottom of the projector leads to a water drain or to an open reservoir to capture the condensed water.



Keep in mind that it can take up to 10 minutes to start the lasers again after they were switched off. If there are only 30 to 45 minutes between the shows it's advisable to keep the lasers on with dowsers closed. When the dowsers are closed the lasers are automatically dimmed.

Start up procedure

1. Switch on the chiller. The status light of the chiller should light up white. See documentation set of the chiller.
2. Press the **Power Switch** to switch the projector **ON**.

As a result the Controller of the projector starts up. All other electronics remain off. The booting process is indicated by the **blue blinking backlight** of the Standby button on the local keypad. Once the Controller is up and running the backlight of the Standby button is changed to continuous white. This is the projector Standby mode. The status light of the projector also flashes green.



Note: The projector always boots up in the same mode (E.g. Standby or Operation) as it was switched off. This procedure assumes that the projector was switched off in Standby mode.

3. Press the **STANDBY** button on the Local Keypad for three seconds or use the Communicator to put the projector in **OPERATIONAL** mode.

As a result the backlight of the Standby button starts blinking green indicating the start up of all other projector electronics. Once this initializing process is done the backlight of the Standby button is changed to continuous green. This is the projector Operational mode. The status light of the projector also lights up green (not flashing).

4. Press the **LIGHT** button on the Local Keypad for three seconds or use the Communicator to activate the lasers.

As a result the backlight of the Light button starts blinking green indicating the projector is in **CONDITIONING** mode. The laser status light on the top of the projector flashes a few times and then lights up continuously white.

Once the projector is conditioned the backlight of the Standby button is changed to continuous green. Now the lasers are active and light can come out of the projector. The status light of the projector remains green and the status light of the lasers remains white.

- Press the **DOWSER** button on the Local Keypad or use the Communicator to open the dowser.

 **Note:** The state of the dowser (open or closed) when starting up the projector will be the same as when the projector was switched off. This procedure assumes that the dowser was closed.



CAUTION: See user's guide of the Communicator Touch Panel to operate and control the Thor.



When for any reason a restart of the projector is required, the content server should be restarted also.

6.2 Switching the Thor OFF

About the switch off process

To switch off the Thor in a safe manner to protect the internal electronics (avoid moisture due to warming up) the temperature inside the sealed compartments has to be brought back to ambient in a controlled manner. This process is called **deconditioning**.

How to switch the Thor OFF?

- Press the Standby button for three seconds on the Local Keypad or use the Communicator Touch Panel to switch the projector from OPERATIONAL mode to STANDBY mode. As a result the lasers are deactivated (if activated) and the projector starts to deconditioning the sealed compartments.
 -  **Caution:** Do not switch off the power from the projector until the laser status light is off. Also make sure not to power off the chiller(s). The chiller(s) should remain on as long as the projector is powered on.
- Switch the projector OFF with the power switch.



Keep in mind that it can take up to 10 minutes to start the lasers again after they were switched off. If there are only 30 to 45 minutes between the shows it's advisable to keep the lasers on with dowser closed. When the dowser is closed the lasers are automatically dimmed.

6.3 Projector ON/OFF cycle explained

Projector ON/OFF cycle

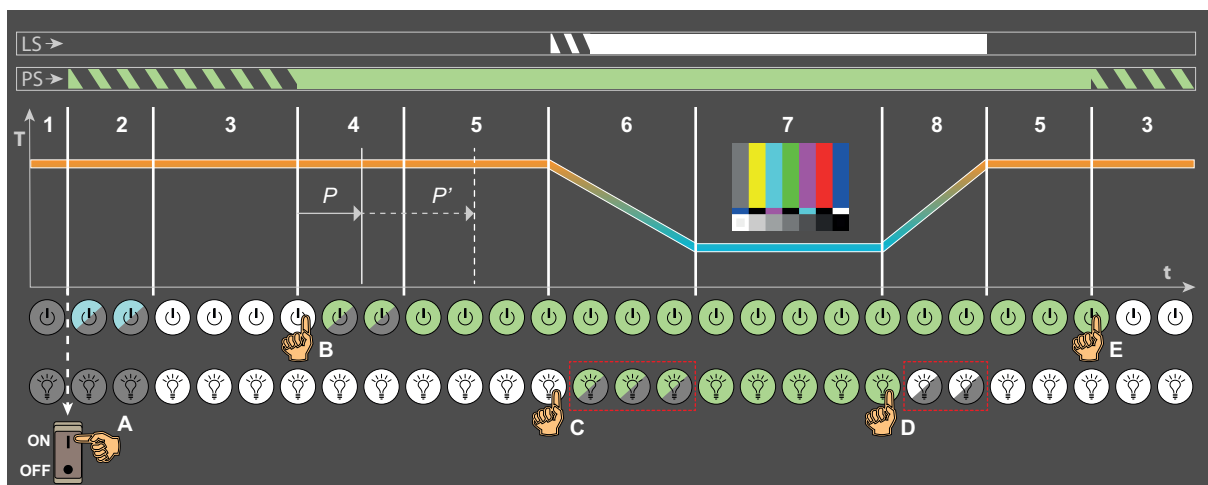

Image 6-1

- LS** Laser Status light.
- PS** Projector Status light (tail light).
- T** Temperature inside sealed compartments.

t time.

A.. Operator manipulations.

E

1..8 Different process stages.

Stage description:

Stage 1 : Projector is **switched off**. Local Keypad is not active. The projector status light (PS) and the laser status light (LS) are off.

Stage 2 : Cinema Controller of the projector is **booting**. This process starts as soon as the power switch is switched on (reference A Image 6-1). This process takes several seconds and during this process the backlight of the Standby button is blinking blue. The projector status light is blinking green (in normal condition, no errors and no warnings). The laser status light remains off.

Stage 3 : Projector is in **Standby** mode. The Cinema Controller is up and running. Only the Standby button and Light button on the Local Keypad are active: The backlight of both buttons is white. The projector status light is blinking green (in normal condition, no errors and no warnings). The laser status light remains off.

Stage 4 : **Initialization** and **PRECONDITIONING**. These two processes start simultaneous as soon as the Standby button is pressed for 3 seconds when the projector is in Standby mode (reference B Image 6-1).

The initialization of all electronic boards takes approximately two minutes and during this process the backlight of the Standby button is blinking green. The projector status light remains blinking green (in normal condition, no errors and no warnings). The laser status light remains off. Note that the projector always boots up in the same mode (E.g. Standby or Operation) as it was switched off.

The PRECONDITIONING process verifies if it's safe to turn on the pump of the cooling circuit and to extract humidity from the sealed compartments without having the risk of condensation. The temperature inside the sealed compartments is kept on ambient level. Following sub-stages take place during PRECONDITIONING:

Stage 4.1 : Checking ambient and internal conditions.

Stage 4.2 : Turning pump on. Reaching liquid flow target.

Stage 4.3 : Flow target reached. Conditioning humidity in the projector.

Stage 4.4 : Cooling started.

Stage 4.5 : Reaching liquid temperature target.

Depending on the environmental circumstances (temperature and humidity) the PRECONDITIONING process will reach its target before (reference P Image 6-1) or after (reference P' Image 6-1) the initialization process is completed. In optimal circumstances it will be before.

Stage 5 : Projector is **Operational** and **PRECONDITIONED**. All electronic boards are up and running. All buttons on the Local Keypad are active. The backlight of the Standby button is green while the backlight of the Light button is white. The projector status light is continuous green (in normal condition, no errors and no warnings). The laser status light remains off.

In PRECONDITIONED mode the chillers are operational and the heat dissipation of the DMDs is under control. Heat dissipated by the active formatter boards is removed. Ingesting of content, creating playlist, etc. is already possible on the ICMP. Also the creation of macros etc. is possible if that is feasible without projecting an image (lasers are not active).

Stage 6 : Projector is **Operational** and in **CONDITIONING** mode. This process starts as soon as the Light button is pressed for 3 seconds (reference C Image 6-1). The laser status light on the top of the projector flashes a few times and then lights up continuously white. The sealed compartments are cooling down from ambient to operating temperature and humidity is extracted. The conditioning process takes approximately 3 to 15 minutes (depends on the environmental conditions). Following sub-stages take place during CONDITIONING:

Stage 6.1 : Checking ambient and internal conditions.

Stage 6.2 : Turning pump on. Reaching liquid flow target.

Stage 6.3 : Flow target reached. Conditioning humidity in the projector.

Stage 6.4 : Cooling started.

Stage 6.5 : Reaching liquid temperature target.

During CONDITIONING the backlight of the Light button is blinking green. The projector status light is continuous green (in normal condition, no errors and no warnings).

Stage 7 : Projector is **Operational** and **CONDITIONED**. Temperature and humidity inside the sealed compartments are within specifications and the lasers are activated. Image is projected on the screen in case the dowsers are open and a source or test pattern is selected. The projector status light is continuous green (in normal condition, no errors and no warnings) and the laser status light on the top of the projector lights up continuously white.

Stage 8 : Projector is in **Operational** and in **DECONDITIONING** mode. This process starts as soon as the Standby button or Light button is pressed for 3 seconds (reference D Image 6-1) while the projector is in conditioning or conditioned mode. The DECONDITIONING mode brings the system back to the PRECONDITIONED state. The laser status light on the top of the projector remains lighting up white. The sealed compartments are brought back to ambient temperature and humidity extraction is stopped. The deconditioning process takes a few minutes and during this process the backlight of the Light button is blinking white. The projector status light is continuous green (in normal condition, no errors and no warnings).

Specifications

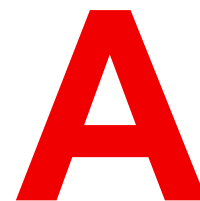

About this chapter

This chapter gives an overview of the specification of your Thor as well as the dimensions and the center of gravity.

Overview

- Specifications of the Thor
- Specifications of the Thor+
- Specifications of the ICMP
- Dimensions of the Thor
- Technical Regulations

A.1 Specifications of the Thor

Specifications

Resolution	4,096 x 2,160
Display technology	three chip 4K 6P RGB Laser DLP
Housing	Sealed DMDs and optical assembly
Input resolution range	up to 4K (4,096 x 2,160)
Light output	Up to 15000 ANSI lumens
Contrast	1,100 : 1 ANSI Contrast (w/WHC Lens) / 6,000 :1 On/Off contrast
Light source	6P RGB Laser
Light source lifetime	30,000 hours or more, replaceable illumination
Lenses	1.13 - 1.72 : 1 4K-VHC LNS Only 1.35 - 1.86 : 1 4K-VHC LNS or DC4K HC 1.46 - 2.10 : 1 4K-VHC LNS or DC4K HC 1.65 - 2.60 : 1 4K-VHC LNS or DC4K HC 2.00 - 3.35 : 1 4K-VHC LNS or DC4K HC
Lens Shift	adjustable: vertical and horizontal, depending on lenses
Inputs	Barco Alchemy ICMP included in the projector: 2x HDMI2.0a (up to 4K 2D 60fps) JPEG2000 2K & 4K DCI play-out High Frame Rates 3D up to 120fps (60fps per eye) 2x 3G-SDI inputs 16x AES/EBU audio channels (2x RJ45)
3D	Color3D (Barco Laser3D): Native 6-primary color-3D system. Only requires color filter glasses (Dolby3D glasses cannot be reused) Active glasses systems Polarization recuperation systems
Control	TCP/IP, 8 x GPIO, RS232
Dimensions	Projector: 744 x 1,445 x 706 mm / 29.3 x 56.9 x 27.8 inches (with feet, no lens) Chiller with the following dimensions: 701 x 701 x 800 mm / 27.6 x 27.6 x 31.5 inches
Weight	Projector: 200kg (~440lb), Chiller: ~115kg (~250lb)
Power requirements	<ul style="list-style-type: none"> • Projector: 200 - 240 / 346 - 415 V 50 - 60 Hz 16A 3W+N+PE (Y connection) • Power cord size range: 4 sq mm to 6 sq mm, 10AWG to 8AWG • Circuit breaker range: 25A to 40A • Chiller: 230 / 400V 3W+N+PE 16A 2.5 sq mm (Y connection) or 208V / 3W+PE (delta connection) Max. 16A per phase
Power consumption	<ul style="list-style-type: none"> • Projector @ full laser power: 3.5 kW (2D or Polarization D) / 2.0 kW (Barco Laser3D - 6P) • Chiller @ full laser power: 2.0 kW (2D or Polarization 3D) / 1.6 kW (Barco Laser3D - 6P)
BTU per hour	18,500 BTU

Noise level (typical at 25°C/ 77°F)	TBD
Operating temperature	30°C (86°F) Max. (projector and chillers)
Operating humidity	75% Max. (projector and chillers)
DCI	Desktop front
Warranty	Limited 2 years parts and labor.
Certifications	CE, ETL/UL/FCC

A.2 Specifications of the Thor+

Specifications

Resolution	4,096 x 2,160
Display technology	three chip 4K 6P RGB Laser DLP
Housing	Sealed DMDs and optical assembly
Input resolution range	up to 4K (4,096 x 2,160)
Light output	Up to 32,000 ANSI lumens
Contrast	1,100 : 1 ANSI Contrast (w/WHC Lens) / 6,000 :1 On/Off contrast
Light source	6P RGB Laser
Light source lifetime	30,000 hours or more, replaceable illumination
Lenses	1.13 - 1.72 : 1 4K-VHC LNS Only 1.35 - 1.86 : 1 4K-VHC LNS or DC4K HC 1.46 - 2.10 : 1 4K-VHC LNS or DC4K HC 1.65 - 2.60 : 1 4K-VHC LNS or DC4K HC 2.00 - 3.35 : 1 4K-VHC LNS or DC4K HC
Lens Shift	adjustable: vertical and horizontal, depending on lenses
Inputs	Barco Alchemy ICMP included in the projector: 2x HDMI2.0a (up to 4K 2D 60fps) JPEG2000 2K & 4K DCI play-out High Frame Rates 3D up to 120fps (60fps per eye) 2x 3G-SDI inputs 16x AES/EBU audio channels (2x RJ45)
3D	Color3D (Barco Laser3D): Native 6-primary color-3D system. Only requires color filter glasses (Dolby3D glasses cannot be reused) Active glasses systems Polarization recuperation systems
Control	TCP/IP, 8 x GPIO, RS232
Dimensions	Projector: 744 x 1,445 x 706 mm / 29.3 x 56.9 x 27.8 inches (with feet, no lens) Two chillers, each with the following dimensions: 701 x 701 x 800 mm / 27.6 x 27.6 x 31.5 inches
Weight	Projector: 235kg (~520lb) Chillers: ~115kg (~250lb) per chiller (two chillers needed)
Power requirements	<ul style="list-style-type: none"> Projector: 200-240/346-415V 50-60Hz 16A 3W+N+PE (Y connection)

	<ul style="list-style-type: none"> • Power cord size range: 4 sq mm to 6 sq mm, 10AWG to 8AWG • Circuit breaker range: 25A to 40A 200-240V 3W+PE 28A 50-60Hz (delta connection) • Power cord size: 6 sq mm, 8AWG • Circuit breaker: 40A • Chillers: 230/400V 3W+N+PE 16A, 2.5 sq mm (Y connection) or 208V / 3W+PE (delta connection) / Max. 16A per phase
Power consumption	<ul style="list-style-type: none"> • Projector @ full laser power: 6.7 kW (2D or Polarization 3D) / 3.6 kW (Barco Laser3D -6P) • Chillers @ full laser power: 3.0 kW (2D or Polarization 3D) / 2.5 kW (Barco Laser3D -6P)
BTU per hour	32,150 BTU
Noise level (typical at 25°C/ 77°F)	Loud
Operating temperature	30°C (86°F) Max. (projector and chillers)
Operating humidity	75% Max. (projector and chillers)
DCI	Desktop front
Warranty	Limited 2 years parts and labor.
Certifications	CE, ETL/UL/FCC
*	Example

A.3 Specifications of the ICMP

Specifications

Integrated Cinema Media Processor	<p>DCI 4K 2D up to 60fps*</p> <p>DCI 4K 3D (24 or 30 fps per eye)*</p> <p>DCI High Frame Rates 2K 3D up to 120fps (60fps per eye)</p> <p>JPEG 2000 bit-rates up to 625Mbps</p> <p>Dual-channel color-correction</p> <p>MPEG-2 (4:2:0 and 4:2:2 up to 60fps)</p> <p>2x HDMI2.0a (up to 4K 2D 60fps)</p> <p>2x 3G-SDI inputs</p> <p>16x AES/EBU audio channels (2x RJ45)</p> <p>8x GPI, 8x GPO (4x RJ45)</p> <p>2x Gbe for content connectivity & ingest</p> <p>2x front-accessible USB 3.0 for fast ingest</p> <p>2x front-accessible USB 2.0</p> <p>Video and audio watermarking: Civolution NexGuard</p> <p>Closed captioning devices: Support for SMPTE 430-10</p> <p>* 4K 24fps is standard. For 4K 60 fps / 4K 3D on ICMP upgrade modules a license is required. Newly-built 4K Barco Alchemy projectors have the license standard included.</p>
Barco Web Commander	<p>Projector dashboard</p> <p>Projector control board</p> <p>Show player/editor/scheduler</p> <p>Automation, 3D, Ingest</p> <p>Smart projector status</p> <p>Via HTML5 web browsers including iOS & Android tablets</p>

	Compatible with free Barco CineMate iOS & Android app
Barco Commander (for touch panel controller)	Projector control board Show Player/Editor/Scheduler Automation, 3D, ingest Dynamic DCP playlists & intermission Smart projector status
Barco Communicator	Projector installation & configuration Projector update & maintenance Barco CineMate App (iOS & Android) - free
Integrated storage	2TB effective storage (RAID-5) / 3x 1TB Hot-swappable 2.5" hard-drives 4TB effective storage (RAID-5) / 3x 2TB Hot-swappable 2.5" hard-drives
Options	ICMP License for 4K 3D/4K 60p - Upgrade Kit ICMP License for HDMI2.0 HDR Licence for Dual Projector
TMS support	Barco Alchemy is supported by the following Theater Management System (TMS) brands: AAM Screenwriter, Ymagis Melody, CFG-Barco, Unique RosettaBridge, ADDE, CinéDigital Manager, GDC, Proyecson, Real Image, Sony, Hollywoodsoftware/Comscore TCC, Kinoton

A.4 Dimensions of the Thor

Dimensions

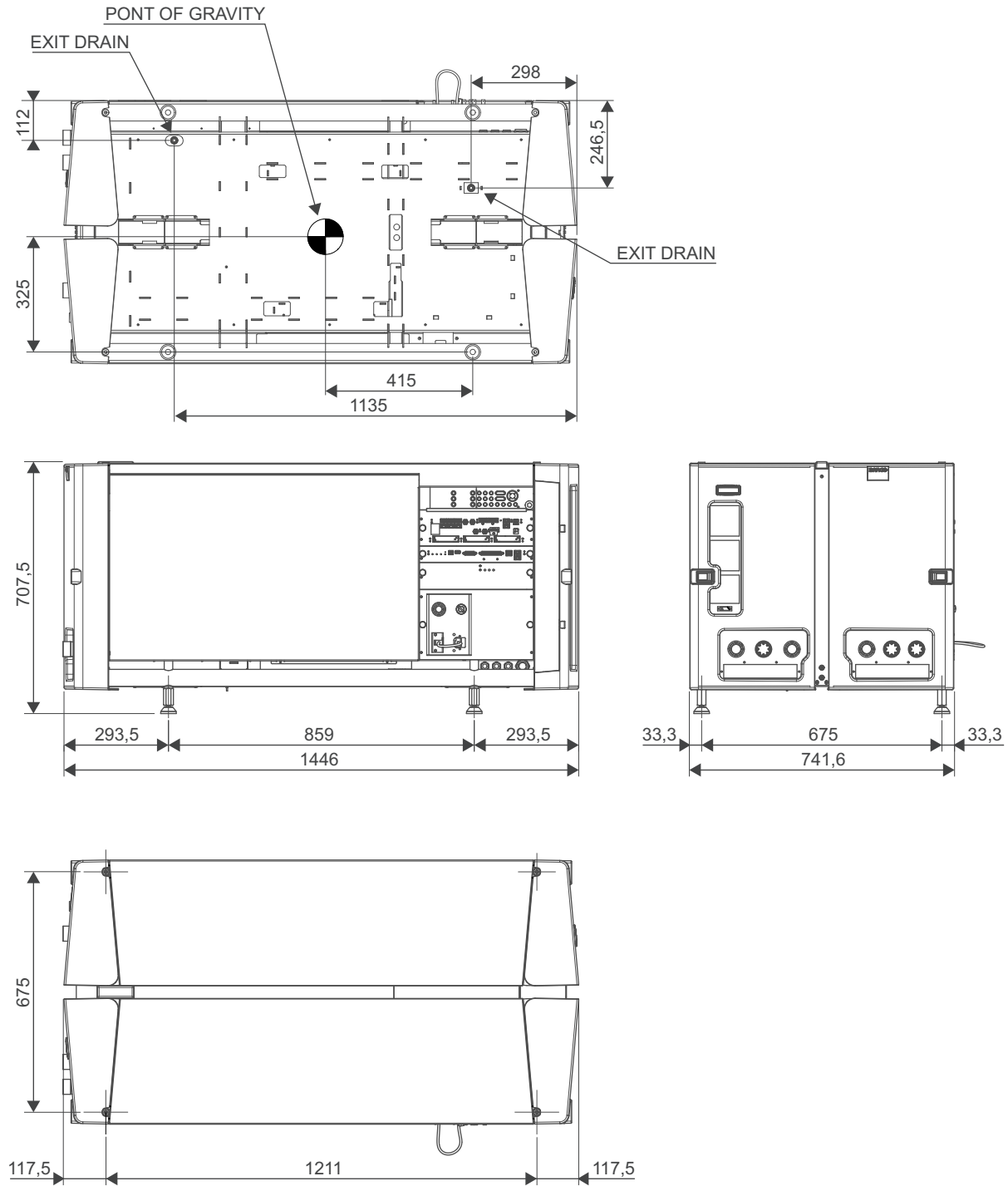

Image A-1: Dimensions given in millimeters.

A.5 Technical Regulations

Certificates



Image A-2:
EAC mark



Image A-3:
Rohs



Image A-4: CE
mark



Image A-5: ETL
mark



Image A-6: FCC
label



Image A-7: RCM
mark

Environmental information

B

Overview

- Disposal information
- China RoHS compliance
- Taiwan RoHS compliance
- Turkey RoHS compliance
- Hazards
- Contact information
- Production address
- Download Product Manual

B.1 Disposal information

Disposal Information

Waste Electrical and Electronic Equipment



This symbol on the product indicates that, under the European Directive (EU) 2015/863 governing waste from electrical and electronic equipment, this product must not be disposed of with other municipal waste. Please dispose of your waste equipment by handing it over to a designated collection point for the recycling of waste electrical and electronic equipment. To prevent possible harm to the environment or human health from uncontrolled waste disposal, please separate these items from other types of waste and recycle them responsibly to promote the sustainable reuse of material resources.

For more information about recycling of this product, please contact your local city office or your municipal waste disposal service.

For details, please visit the Barco website at: <http://www.barco.com/en/AboutBarco/weee>

Disposal of batteries in the product



This product contains batteries covered by the Directive 2006/66/EC which must be collected and disposed of separately from municipal waste.

If the battery contains more than the specified values of lead (Pb), mercury (Hg) or cadmium (Cd), these chemical symbols will appear below the crossed-out wheeled bin symbol.

By participating in separate collection of batteries, you will help to ensure proper disposal and to prevent potential negative effects on the environment and human health.

WEEE Information

This product conforms to all requirements of the EU Directive on waste electrical and electronic equipment (WEEE). This product shall be recycled properly. It can be disassembled to facilitate proper recycling of its individual parts.

Consult your dealer or relevant public authority regarding drop-off points for collection of WEEE. For details, please visit the Barco website at: <http://www.barco.com/en/aboutBarco/weee>.

B.2 China RoHS compliance

中国大陆 RoHS (Chinese Mainland RoHS)

根据中国大陆《电器电子产品有害物质限制使用管理办法》（也称为中国大陆RoHS），以下部分列出了Barco产品中可能包含的有毒和/或有害物质的名称和含量。中国大陆RoHS指令包含在中国信息产业部MCV标准：“电子信息产品中有毒物质的限量要求”中。

According to the “Management Methods for the Restriction of the Use of Hazardous Substances in Electrical and Electronic Products” (Also called RoHS of Chinese Mainland), the table below lists the names and contents of toxic and/or hazardous substances that Barco’s product may contain. The RoHS of Chinese Mainland is included in the MCV standard of the Ministry of Information Industry of China, in the section “Limit Requirements of toxic substances in Electronic Information Products”.

零件项目(名称) Component Name	有毒有害物质或元素 Hazardous Substances or Elements					
	铅 (Pb)	汞 (Hg)	镉 (Cd)	六价铬 (Cr6+)	多溴联苯 (PBB)	多溴二苯 醚 (PBDE)
印制电路配件 Printed Circuit Assemblies	X	O	X	O	O	O
外接电(线)缆 External Cables	X	O	O	O	O	O
内部线路 Internal wiring	X	O	O	O	O	O
镜头支架 Lensholder	X	O	O	O	O	O
光学镜头 Optical lenses	X	O	O	O	O	O
螺帽,螺钉(栓),螺旋(钉),垫圈, 紧固件 Nuts, bolts, screws, washers, Fasteners	X	O	O	O	O	O
电源供应器 Power Supply Unit	X	O	O	O	O	O
风扇 Fan	X	O	O	O	O	O

本表格依据SJ/T 11364的规定编制
This table is prepared in accordance with the provisions of SJ/T 11364.
O: 表示该有毒有害物质在该部件所有均质材料中的含量均在 GB/T 26572 标准规定的限量要求以下。
O: Indicates that this toxic or hazardous substance contained in all of the homogeneous materials for this part is below the limit requirement in GB/T 26572.
X: 表示该有毒有害物质至少在该部件的某一均质材料中的含量超出 GB/T 26572 标准规定的限量要求。
X: Indicates that this toxic or hazardous substance contained in at least one of the homogeneous materials used for this part is above the limit requirement in GB/T 26572.



在中国大陆销售的相应电子信息产品 (EIP) 都必须遵照中国大陆《电子电气产品有害物质限制使用标识要求》标准贴上环保使用期限 (EFUP) 标签。Barco产品所采用的EFUP标签 (请参阅实例, 徽标内部的编号使用于指定产品) 基于中国大陆的《电子信息产品环保使用期限通则》标准。

All Electronic Information Products (EIP) that are sold within Chinese Mainland must comply with the "Marking for the restriction of the use of hazardous substances in electrical and electronic product" of Chinese Mainland, marked with the Environmental Friendly Use Period (EFUP) logo. The number inside the EFUP logo that Barco uses (please refer to the photo) is based on the "General guidelines of environment-friendly use period of electronic information products" of Chinese Mainland.

B.3 Taiwan RoHS compliance

限用物質含有情況標示聲明書 (Declaration of the Presence Condition of the Restricted Substances Marking)

設備名稱： 數字電影放映機 (投影儀) ， 型號 (型式) ： DP4K-20LHC Equipment name: Digital Cinema Projector, Type designation: DP4K-20LHC						
限用物質及其化學符號 Restricted substances and its chemical symbols						
單元 Unit	鉛 Lead (Pb)	汞 Mercury (Hg)	鎘 Cadmium (Cd)	六價鉻 Hexavalent chromium (Cr6+)	多溴聯苯 Polybrominated biphenyls (PBB)	多溴二苯醚 Polybrominated diphenyl ethers (PBDE)
印製電路板配件 Printed Circuit Assemblies	—	○	—	○	○	○
外接電 (線) 纜 External Cables	—	○	○	○	○	○
內部線路 Internal wiring	—	○	○	○	○	○
鏡頭支架 Lensholder	—	○	○	○	○	○
光學鏡頭 Optical lenses	—	○	○	○	○	○
螺帽, 螺釘 (栓), 螺旋 (釘), 墊圈, 緊固件 Nuts, bolts, screws, washers, Fasteners	—	○	○	○	○	○
電源供應器 Power Supply Unit	—	○	○	○	○	○
風扇 Fan	—	○	○	○	○	○
備考1. “超出0.1 wt %” 及 “超出0.01 wt %” 係指限用物質之百分比含量超出百分比含量基準值。 Note 1 : “Exceeding 0.1 wt %” and “exceeding 0.01 wt %” indicate that the percentage content of the restricted substance exceeds the reference percentage value of presence condition. 備考2. “○” 係指該項限用物質之百分比含量未超出百分比含量基準值。 Note 2 : “○” indicates that the percentage content of the restricted substance does not exceed the percentage of reference value of presence. 備考3. “—” 係指該項限用物質為排除項目。 Note 3 : The “—” indicates that the restricted substance corresponds to the exemption.						

B.4 Turkey RoHS compliance

Turkey RoHS compliance



■ Türkiye Cumhuriyeti: AEEE Yönetmeliğine Uygundur.

[Republic of Turkey: In conformity with the WEEE Regulation]

B.5 Hazards

Safety notice Sodium Carbonate (Na₂CO₃)

According to the Material Safety Data Sheet (MSDS), Sodium Carbonate could cause the following hazards:

- Potential Acute Health Effects: Hazardous in case of skin contact (irritant), of eye contact (irritant), of ingestion, of inhalation (lung irritant).
- Potential Chronic Health Effects: Slightly hazardous in case of skin contact (sensitizer). The substance may be toxic to upper respiratory tract, skin, eyes. Repeated or prolonged exposure to the substance can produce target organ damage.

B.6 Contact information

Barco contact information

Registered office address: President Kennedypark 35, 8500 Kortrijk, Belgium

Contact address: Beneluxpark 21, 8500 Kortrijk, Belgium

Importers contact information

To find your local importer, contact Barco directly or one of Barco's regional offices via the contact information given on Barco's web site, www.barco.com.

B.7 Production address

Factories

Barco NV (BELGIUM)

President Kennedypark 35, B-8500 Kortrijk

CFG Barco (Beijing) Electronics Co. Ltd.

中影巴可 (北京) 电子有限公司

3rd Floor, Barco Factory, No.16 Changsheng Road, Changping District, 102200, Beijing, P.R.C.

北京市昌平区中关村科技园区昌平园昌盛路16号巴可工厂第3层 邮政编码 : 102200

Barco Visual (Beijing) Electronics Co. Ltd.

巴可伟视 (北京) 电子有限公司

No.16 Changsheng Road, Changping District, 102200, Beijing, P.R.C

北京市昌平区中关村科技园区昌平园昌盛路16号 邮政编码 : 102200

Made in information

The made in country is indicated on the product ID label on the product itself.

Production date

The month and year of production is indicated on the product ID label on the product itself.

B.8 Download Product Manual

Download Product Manual

Product manuals and documentation are available online at www.barco.com/td.

Registration may be required; follow the instructions given on the website.

IMPORTANT! Read Installation Instructions before connecting equipment to the mains power supply.

Glossary

HD

Hazard Distance (HD) is the distance measured from the projection lens at which the intensity or the energy per surface unit becomes lower than the applicable exposure limit on the cornea or on the skin. The light beam is considered (to be) unsafe for exposure if the distance from a person to the light source is less than the HD.

HD

Hazard Distance (HD) is the distance measured from the projection lens at which the intensity or the energy per surface unit becomes lower than the applicable exposure limit on the cornea or on the skin. The light beam is considered (to be) unsafe for exposure if the distance from a person to the light source is less than the HD.

RS232

An Electronic Industries Association (EIA) serial digital interface standard specifying the characteristics of the communication path between two devices using either D-SUB 9 pins or D-SUB 25 pins connectors. This standard is used for relatively short-range communications and does not specify balanced control lines. RS-232 is a serial control standard with a set number of conductors, data rate, word length and type of connector to be used. The standard specifies component connection standards with regard to computer interface. It is also called RS-232-C, which is the third version of the RS-232 standard, and is functionally identical to the CCITT V.24 standard. Logical '0' is $> +3V$, Logical '1' is $< -3V$. The range between $-3V$ and $+3V$ is the transition zone.

USB

Universal Serial Bus (USB) is an industry standard developed in the mid-1990s that defines the cables, connectors and communications protocols used in a bus for connection, communication, and power supply between computers and electronic devices. **USB 2.0** (also called "Hi-Speed"), adding higher maximum signaling rate of 480 Mbit/s (effective throughput up to 35 MB/s or 280 Mbit/s), in addition to the "USB 1.x Full Speed" signaling rate of 12 Mbit/s.[16] USB 2.0 connectors are usually colored black. **USB 3.0** defines a new SuperSpeed mode with a signaling speed of 5 Gbit/s and a usable data rate of up to 4 Gbit/s (500 MB/s). A USB 3.0 port is usually colored blue, and is backwards compatible with USB 2.0.

DisplayPort

Digital display interface developed by the Video Electronics Standards Association (VESA). This royalty-free interface is primarily used to connect a video source to a display device such as a computer monitor, though it can also be used to transmit audio, USB, and other forms of data. VESA designed it to replace VGA, DVI, and FPD-Link. Backward compatibility to VGA and DVI by using active adapter dongles enables users to use DisplayPort fitted video sources without replacing existing display devices.

HDCP

High-bandwidth Digital Content Protection is a form of digital copy protection developed by Intel Corporation to prevent copying of digital audio and video content as it travels across DisplayPort, Digital Visual Interface (DVI), High-Definition Multimedia Interface (HDMI), Gigabit Video Interface (GVIF), or Unified Display Interface (UDI) connections, even if such copying would be permitted by fair use laws. The specification is proprietary, and implementing HDCP requires a license.

3G-SDI

Serial Digital Interface (SDI) is a serial link standardized by ITU-R BT.656 and the Society of Motion Picture and Television Engineers (SMPTE). SDI transmits uncompressed digital video over 75-ohm coaxial cable within studios, and is seen on most professional video infrastructure equipment. The first revision of the standard, SMPTE 259M, was defined to carry digital representation of analog video such as NTSC and PAL over a serial interface and is more popularly known as standard-definition (SD) SDI. The data rate required to transmit SD SDI is 270 Mbps. With the advent of high-definition (HD) video standards such as 1080i and 720p, the interface was scaled to handle higher data rates of 1.485 Gbps. The 1.485-Gbps serial interface is commonly called the HD SDI interface and is defined by SMPTE 292M, using the same 75-ohm coaxial cable. Studios and other video production facilities have invested heavily on the hardware infrastructure for coaxial cable and have a vested interest in extending the life of their infrastructure. Fortunately, SMPTE recently ratified a new standard called SMPTE 424M that doubles the SDI data rates to 2.97 Gbps using the same 75-ohm coaxial cable. This new standard, also called 3-Gbps (3G)-SDI, enables higher resolution of picture quality required for 1080p and digital cinema.

HDMI

HDMI (High-Definition Multimedia Interface) is a compact audio/video interface for transferring uncompressed video data and compressed/uncompressed digital audio data from a HDMI-compliant device ("the source device") to a compatible computer monitor, video projector, digital television, or digital audio device. HDMI is a digital replacement for existing analog video standards.

HDMI

HDMI (High-Definition Multimedia Interface) is a compact audio/video interface for transferring uncompressed video data and compressed/uncompressed digital audio data from a HDMI-compliant device ("the source device") to a compatible computer monitor, video projector, digital television, or digital audio device. HDMI is a digital replacement for existing analog video standards.

Trusted Device List (TDL)

The Goal of the TDL is to maintain timely and accurate information on participating auditoriums so that participating subscribers can obtain information needed to issue KDMs. The TDL has several data sources: Device manufacturers, Exhibitors, Deployment Entities, Integrators, Service Providers (interacting with Exhibitors), regional authorities and Support.

Public Key Infrastructure (PKI)

PKI is a framework for creating a secure method for exchanging information based on public key cryptography. The foundation of a PKI is the certificate authority (CA), which issues digital certificates that authenticate the identity of organizations and individuals over a public system such as the Internet. The certificates are also used to sign messages, which ensures that messages have not been tampered with.

***.pem**

Privacy-enhanced Electronic Mail. File format used to distribute digital signed certificates. Base64 encoded DER certificate, enclosed between "-----BEGIN CERTIFICATE-----" and "-----END CERTIFICATE-----"

Key Delivery Message (KDM)

The security key for each movie is delivered in a unique KDM for each digital cinema server. The security key is encrypted within the KDM, which means that the delivery of a KDM to the wrong server or wrong location will not work, and thus such errors cannot compromise the security of the movie. The KDM is a small file, and is typically emailed to the exhibitor. To create the correct set of KDMs for a site requires knowledge of the digital certificate in the projection system's media block.

Digital Cinema Package (DCP)

A Digital Cinema Package (DCP) is a collection of digital files used to store and convey Digital Cinema (DC) audio, image, and data streams. The term has been defined by Digital Cinema Initiatives (DCI). General practice adopts a file structure that is organized into a number of usually multi-gigabyte size Material eXchange Format (MXF) files, which are separately used to store audio and video streams, and auxiliary index files in XML format. The MXF files contain streams that are compressed, encoded, and encrypted, in order to reduce the huge amount of required storage and to protect from unauthorized use. The image part is JPEG 2000 compressed, whereas the audio part is linear PCM. The adopted (optional) encryption standard is AES 128 bit in CBC mode. The newer SMPTE standards are used to conform the recommendations among different tool vendors and producers. Interop, the legacy DCP standard, is still required to be supported by DCP players.

Digital Cinema Initiatives (DCI)

DCI is a joint venture of Disney, Fox, Paramount, Sony Pictures Entertainment, Universal and Warner Bros. Studios. DCI's primary purpose is to establish and document voluntary specifications for an open architecture for digital cinema that ensures a uniform and high level of technical performance, reliability and quality control. Note that the DCI specification is not a standard. Standards for digital cinema are the domain of the Society of Motion Picture and Television Engineers (SMPTE). "DCI compliant" is a term used to describe products that conform to the DCI specification. Products that have been tested per the DCI Compliance Test Plan (CTP) are posted at the DCI compliance web site. Notably, DCI compliance does not require compliance to the full set of SMPTE DCP standards. A copy of the most recent DCI specification can be downloaded from the DCI website (<http://dcimovies.com>).

Index

Numbers/Symbols

3G-SDI 44

A

About this manual 8
Address 83
AUDIO-AES 42
Awake 31

B

Backlight
Color 27

C

CertID 57
Cinema Controller 34
Color
Backlight 27
Communication 29
AUDIO-AES 42
GPI 42
GPO 42
Introduction 30
LAN 42
SYNC 42
USB 2.0 42
USB 3.0 43
USB port 34
Communication ports 34, 42
Configuration 59

D

Device certificate 57
Download 61
ICMP 61
Dimensions
Thor 76
DisplayPort 44
Specifications 44
Download

Device certificate 61
Product manual 83

E

Enclosed projection 18
Environmental information 79
Disposal information 80
RoHS compliance 80
Taiwan 82
Turkey 82
Expected
From you 8

F

Focus 26

G

General considerations 10
GPI 42
GPO 42

H

Hazard Distance 16, 18
Modifying optics 20
Hazardous Chemicals 14
Hazards 83
HDD 40
About 40
Degraded mode 41
RAID broken 41
RAID recovery 41
Remove 62–63
Storage 41
Storage capacity 41
Validated list 41
HDMI 44
HDMI 1.4
Specifications 52
HDMI 2.0 44
Specifications 49
High Brightness precautions 16

I

- ICMP 37
- ICMP HDD
 - Status LEDs 56
 - Troubleshooting 56
- ICMP reset 60
- ICMP introduction 39
- Important safety instructions 11
- Importer 83
- Input 29
 - Introduction 30
- Input & communication
 - Communication ports 34
- Input & Communication
 - Local Keypad 32
- Install
 - Lens 23
- Internal clock 60
- Introduction
 - Communication 30
 - Input 30

K

- KDM 57
- Keypad
 - Backlight
 - Color 27

L

- LAN 42
- Laser status 31–32
- Lens
 - Focus 26
 - Installation 23
 - Removal 25
 - Shift 26
 - Zoom 26
- Lens Holder
 - Lenses 21
- lens selection 22
- Lenses
 - Available 22
 - Lens Holder 21
- Local Keypad 32

M

- Manual
 - Use 8

N

- Network Time Protocol 60
- Notice on optical radiation
 - Optical radiation 10
- Notice on safety 10

O

- Obtain
 - Device certificate 61
- ON/OFF 67
- Owner's record 10

P

- Product safety labels 14
- Production 83
- Projector ON/OFF explained 67
- Projector status 30

R

- Rear projection 18
- Remove
 - HDD 62–63
 - Lens 25
- Reset button 60
- RS232 36

S

- Safety 9
 - Battery explosion 12
 - Electrical shock 11
 - Fire hazard 12
 - Hazard Distance 16, 18
 - Hazardous Chemicals 14
 - Personal injury 12
 - Projector damage 13
 - Safety Data Sheet (SDS) 14
 - Servicing 13
- Safety Data Sheet (SDS) 14
- Safety training 10
- SDI
 - Specifications 46
- Serial communication 36
- Shift 26
- Source input
 - 3G-SDI 44
 - DisplayPort 44
 - HDMI 44
 - HDMI 2.0 44
- Source input ports 43
- Specification
 - ICMP 74
- Specifications 71
 - DisplayPort 44
 - HDMI 1.4 52
 - HDMI 2.0 49
 - SDI 46
 - Thor 72
 - Thor+ 73
- Standby mode 31
- Starting up 65
 - Switching on 66
- Status LEDs 55
 - ICMP HDD 56
- Status light 30, 32

Status light lasers 31
Switching OFF 67
Switching on 66
SYNC 42

T

Tail light 30
TDL 57
Technical Regulations 77
This manual 7

U

USB 2.0 42
USB 3.0 43
USB port 34
User definition 11

W

Welcome 7

Z

Zoom 26

